

EXCITATION OF LONGITUDINAL COUPLED-BUNCH OSCILLATIONS WITH THE WIDE-BAND CAVITY IN THE CERN PS

L. Ventura*, M. Migliorati, Sapienza Universita' di Roma and INFN-Roma1, Rome, Italy
H. Damerou, G. Sterbini, CERN, Geneva, Switzerland

Abstract

Longitudinal coupled-bunch oscillations in the CERN Proton Synchrotron have been studied in the past years and they have been recognized as one of the major challenges to reach the high brightness beam required by the High Luminosity LHC project. In the frame of the LHC Injectors Upgrade project in 2014 a new wide-band Finemet cavity has been installed in the Proton Synchrotron as a part of the coupled-bunch feedback system. To explore the functionality of the Finemet cavity during 2015 a dedicated measurement campaign has been performed. Coupled-bunch oscillations have been excited with the cavity around each harmonic of the revolution frequency with both a uniform and nominal filling pattern. In the following the measurements procedure and results are presented.

INTRODUCTION

One of the major limitations for the LHC-type beams in the Proton Synchrotron (PS) are longitudinal coupled-bunch (CB) oscillations which are present after transition during beam acceleration and at flat-top energy [1]. Two major issues related to CB instability have been observed: (1) unequal allocation of charge distribution between the different bunches caused by the asymmetry of the beam splitting ($h = 21 \rightarrow 42 \rightarrow 84$) at extraction energy; (2) limited reproducibility of the bunch length along the batch. Extensive beam tests were performed with the existing analog CB feedback system [2] driving a spare acceleration cavity to study the parameter space in view of the increased intensity for LHC-type beams and to define the requirements for the new feedback [3]. To cover all possible CB oscillation modes simultaneously a Finemet cavity [4], the first wide-band cavity in the PS, has been installed together with a new digital low level radio frequency (LLRF) system, based on the hardware developed for the PS 1-turn delay feedback (FB) system [5]. During 2015 machine development studies have been performed to commission the new prototype LLRF and the wide-band longitudinal damper. Both filling patterns, nominal (where only 18 bunches are accelerated in $h = 21$, leaving a gap of three empty buckets for extraction) and uniform ($h = 21$ with 21 bunches) have been studied, lower and upper synchrotron frequency sidebands (LSB, USB) of the revolution frequency, f_{rev} , have been excited, and multiple scans in frequency, voltage and oscillation mode number have been performed. In this paper we will present an overview of the new FB system, as well as the excitation firmware setup and measurements results.

* letizia.ventura@uniroma1.it

THE LONGITUDINAL COUPLED-BUNCH FEEDBACK

The design of the new wide-band cavity, driven by solid state amplifiers, is based on the frequency characteristics of the Finemet magnetic alloy. With a frequency range from 0.4 – 5.5 MHz and a maximum RF voltage, V_{RF} , of about 5 kV, the cavity is ment to damp CB oscillations rather than to target acceleration. It is also the first time that transistor power amplifiers are operated in the radiation environment close to the beam in the PS. Of the 6 available gaps, 4 were operational in 2015, with a maximum peak voltage of 3.5 kV. Due to the symmetry of the spectral lines of the excited modes, a bandwidth of 5 MHz, corresponding to half of the accelerating frequency, $f_{RF} = hf_{rev}$, allows to damp all the oscillation modes at $h = 21$ [6]. A simplified model of the signal processing implemented is shown in Fig. 1 for one harmonic.

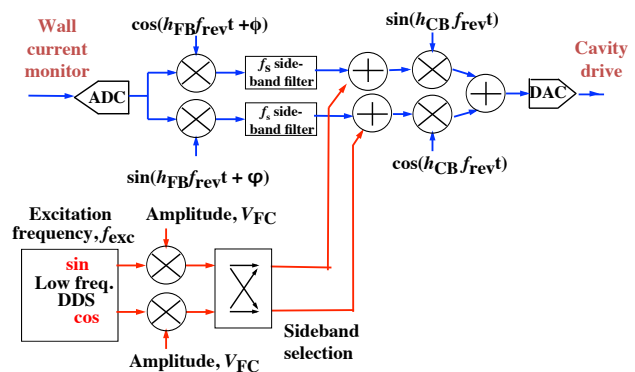

Figure 1: Coupled-bunch feedback system signal processing and excitation setup.

The beam phase is detected with a wall current monitor and down-converted through a local oscillator at harmonic h_{FB} ; in order to filter the synchrotron frequency, f_s , sidebands, a sharp notch is necessary to separate them from f_{rev} harmonics, which are attenuated by more than 40 dB compared to sidebands. Additionally, the phase of the transfer function changes by 180° at the f_{rev} harmonics. Due to the symmetry of the beam spectrum the signal can then be up-converted at harmonic h_{CB} so that the sum of down- and up-conversion harmonics becomes $h_{FB} + h_{CB} = 21$, the RF harmonic. In order to explore the functionality of the Finemet cavity, excitation measurements with the feedback in open loop were necessary. The initial part of the chain (down-conversion and f_s filtering) has been substituted by an external perturbation. A low frequency numerical oscillator (DDS) in the firmware of the LLRF was used to excite

the beam with the Finemet cavity by changing parameters like frequency f_{exc} , voltage V_{FC} and h_{CB} . In the following we will report the open loop measurements results.

EXCITATION MEASUREMENTS WITH THE WIDE-BAND CAVITY

During the measurement campaign we used an intensity of $\sim 1.3 \cdot 10^{11}$ protons per bunch (in $h = 84$ with the nominal LHC-beam cycle) and $V_{RF} = 165$ kV. These result in $f_s \approx 390$ Hz and $f_{rev} \approx 476$ kHz. After transition crossing ($\gamma_t = 6.1$) the beam has been excited using the setup shown in Fig. 1. After having switched off the excitation, the longitudinal position of the bunches has been recorded using a 14 bit digitizer with 400 MHz sampling rate. The mode analysis technique with circulant matrix approach [7] has been adopted to extract the evolution of amplitude and phase of the dipolar modes.

As Sacherer [6], the dipolar CB oscillation modes occur at frequency:

$$f = \mu f_{rev} \pm f_s \quad (1)$$

in the beam spectrum, where $\mu = 0 \dots h - 1$ is the mode number with the phase advance of $2\pi\mu/n_b$, with n_b number of bunches. The system illustrated in Fig. 1 allows, through the Finemet cavity, to inject an excitation RF signal at a frequency:

$$f_{CB} = h_{CB} f_{rev} \pm f_{exc} \quad (2)$$

where $h_{CB} = 0 \dots h - 1$, and f_{exc} is the parameter that allows to select the synchrotron frequency sideband.

Frequency Scan, f_{exc}

A preliminary set of measurements was necessary to explore the sensitivity of the excitation with the new wide-band cavity. Keeping the voltage, V_{FC} , constant and choosing a specific CB oscillation mode, h_{CB} , the excitation frequency f_{exc} has been scanned.

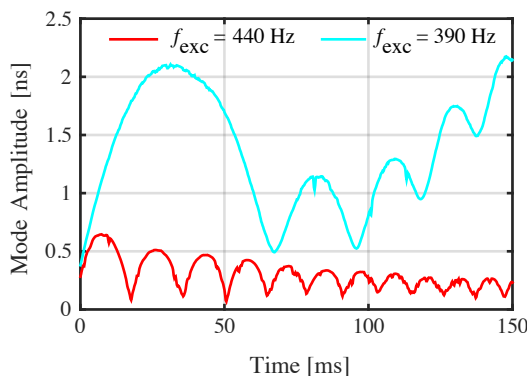

Figure 2: Plot of $h_{CB} = 1$ mode amplitude versus time for two different values of f_{exc} .

As expected, for $f_{exc} = 0$ no excitation is observed since we are exciting the beam at the revolution frequency harmonic $h_{CB} f_{rev}$. During the frequency scan coupled-bunch oscillations appear as f_{exc} approaches the regime of the synchrotron frequency and actually a beating behavior is detected for the mode amplitudes as shown in Fig. 2. Two different cases are highlighted:

- At $f_{exc} = 390$ Hz (blue curve in figure), the oscillation mode amplitude grows almost linearly for about 25 ms until a beating behavior appears due to the changing synchrotron frequency during acceleration;
- At $f_{exc} = 440$ Hz (red curve in figure), a beating at approximately $f_{exc} - f_s$ is observed.

From these observations we can conclude that the system behaves like a driven harmonic oscillator.

Oscillation Mode Scan, h_{CB}

During the commissioning of the system one important test was to verify that the Finemet cavity could excite independently all the dipolar modes. Figure 3 shows an example of the mode spectrum following the excitation of $h_{CB} = 16$ in the case of 21 bunches in $h = 21$. Lower and upper sidebands have been excited and a mode analysis has been performed to obtain the histogram plot which represents the mode amplitude at the end of data recording. As expected, the beam spectrum shows a pure excitation of modes 5 and 16, respectively.

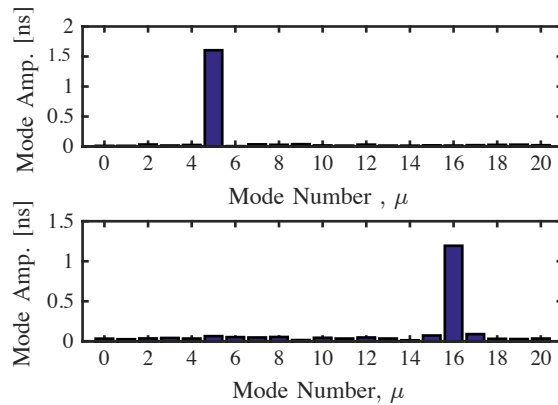

Figure 3: Mode amplitude for the uniform filling pattern, following the excitation of $h_{CB} = 16$ LSB (top) and USB (bottom).

A summary of the measured mode spectra following the scan of h_{CB} for the USB only, for 21 bunches in $h = 21$, is shown in Fig. 4. The color coding is referring to the mode amplitude as shown in Fig. 3. The measurements confirm that all modes can be excited individually [3].

On the other hand with a batch of 18 bunches in $h = 21$, the excitation at f_s -sidebands of f_{rev} harmonics does not correspond to the excitation of a single CB mode, as visible in Fig. 5. A spectrum containing several CB modes centered around $\mu = 18/21 h_{CB}$ is observed in this case.

In addition to the mode scan, a linear fit on the evolution of the amplitude for each mode has been performed during the

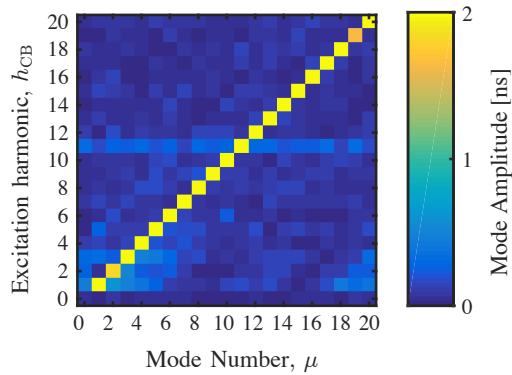

Figure 4: Summary of mode scan for 21 bunches in $h = 21$. On the vertical axis we have the CB mode excited and on the horizontal axis the mode of oscillations observed following the excitation.

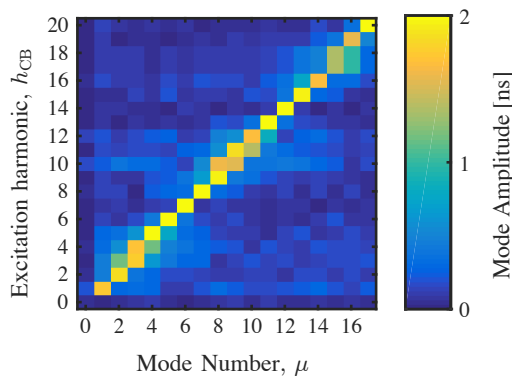

Figure 5: Summary of mode scan for 18 bunches in $h = 21$. On the vertical axis we have the CB mode excited and on the horizontal axis the CB mode of oscillations observed following the excitation.

excitation, and the linear growth rate, α , has been evaluated. The results are summarized in Fig. 6 (bottom plot). Larger α are achieved for modes $h_{CB} < 10$ which correspond to the frequency where the cavity impedance is larger. Figure 6, top plot, represents the absolute value of the transfer function, $|s_{21}|$, of the Finemet cavity.

Excitation Voltage Scan, V_{FC}

The linearity of the Finemet cavity and the excitation system was verified by measuring the mode growth rate on the uniform filling pattern of 21 bunches on $h = 21$, as a function of V_{FC} . The result plotted in Fig. 7 shows that the excitation is linear.

CONCLUSION

After its installation in early 2014 an extensive machine development program has been carried out to qualify the new Finemet wide-band damper cavity and its digital coupled-bunch LLRF FB system. The complete prototype feedback

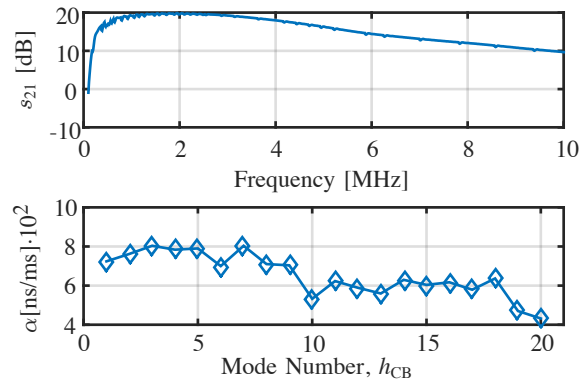

Figure 6: Absolute part of the Finemet cavity transfer function in logarithmic units (top). Linear growth rate α versus CB oscillation mode (bottom).

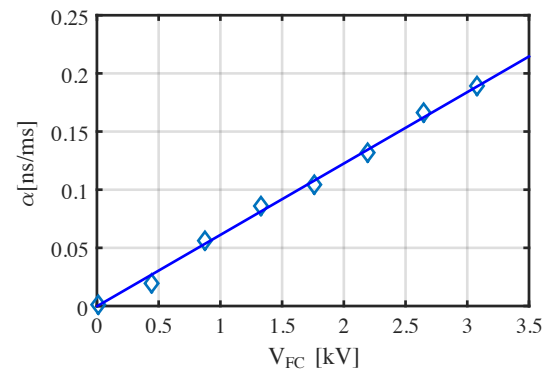

Figure 7: Voltage scan summary: excitation of single harmonic, $h_{CB} = 1$, and observation of the growth rate for different values of voltage, V_{FC} , from the Finemet cavity.

chain of pick-up, digital processing and Finemet kicker has been installed and commissioned. Excitation measurements with FB in open loop show that the Finemet cavity interacts with the beam as expected and that the different coupled-bunch oscillation modes can be excited individually. First tests at the end of 2015 confirm that coupled-bunch oscillations can be damped by the Finemet cavity in closed loop [8]. Full test and characterization will be carried out during 2016.

ACKNOWLEDGEMENT

The authors acknowledge G. Arduini, S. Gilardoni, M. Haase, M. Paoluzzi, D. Perrelet and Y. Papaphilippou for the fruitful discussions and the PS OP team for its support during the measurement campaign.

REFERENCES

- [1] H. Damerou, S. Hancock, and M. Schokker, "Longitudinal performance with high-density beams for the LHC in the CERN PS", in *Proc. of HB 2010*, Mohrschach, Switzerland, paper MOPD52, p. 193.

- [2] J.-L. Vallet, "Amortissement des instabilités longitudinales de modes couplés", unpublished presentation, 2005.
- [3] H. Damerau *et al.*, "Longitudinal coupled-bunch oscillation studies in the CERN PS", in *Proc. of IPAC'13*, Shanghai, China, paper TUPWA044, p. 1808.
- [4] M. Paoluzzi, M. Haase *et al.*, "Studies on a wideband, solid-state driven RF system for the CERN PS Booster", CERN, Geneva, Switzerland, Rep. CERN-ATS-2012-113, 2012.
- [5] D. Perrelet, "New CERN PS 10 MHz Cavity One-turn Feedback Hardware and Beam Tests", in *Proc. of LLRF 2013*, Lake Tahoe, USA.
- [6] F. Pedersen and F. Sacherer, "Theory and performance of the longitudinal active damping system for the CERN PS booster", in *Proc. of PAC'77*, Chicago, USA, p. 1396.
- [7] L. Ventura *et al.*, "Simulations and measurements of longitudinal coupled-bunch instabilities in the CERN PS", in *Proc. of IPAC'15*, Richmond, USA, paper MOPJE072, p. 479.
- [8] H. Damerau *et al.*, "Signal processing for the coupled-bunch feedback in the CERN PS", in *Proc. of LLRF 2015*, Shanghai, China.