



Active Muon Shield

-Preliminary Design Report-

V Bayliss, M Courthold, T Rawlings
STFC Rutherford Appleton Laboratory

Abstract

This report summarises the initial design study which was carried out for the SHiP magnetic muon filter – which is proposed to consist of a 40m beamline of seven magnets generating a 1.8T By field over defined cross-section. This is intended to sweep unwanted muons off the beamline to prevent them reaching the detector. The magnetic shield is an alternative to a passive tungsten shield.

This work was carried out in three sections. Initially the magnets were considered in isolation to establish whether they were theoretically feasible to build and the impact of the iron yoke shape and material was considered. Next the beamline was considered as a whole; this included issues such as the impact of neighbouring magnets and the hadrons stopper, and also building a model of the complete beamline whose magnetic fields could be exported for use in particle modelling. Finally, some consideration was given to the manufacture and operational issues, including costs.

Active Muon Shield
Preliminary Magnet Design Report

Change Record

Issue	Change	Person
1.0	Initial issue	VB

Active Muon Shield
Preliminary Magnet Design Report

Table of Contents

1. Overview	6
1.1. Specification.....	6
1.2. Modelling	7
2. Preliminary Modelling.....	9
2.1. Material Selection	9
2.2. Yoke optimisation	12
2.2.1. C0 Yoke Shape.....	12
2.2.2. Gap between centre and return field – C0 and C4	13
2.3. Coil Location.....	16
2.3.1. Radiation	16
2.3.2. Effect on Flux.....	16
3. Beamline Modelling.....	18
3.1. Spacing between magnets in z.....	20
3.2. Hadron stopper	21
3.3. Force on coils	23
4. Practical Considerations.....	25
4.1. GO Steel Yoke.....	25
4.1.1. Joints	25
4.1.2. Manufacture	26
4.2. Coils.....	28
4.2.1. Cooling	28
4.2.2. Material.....	29
4.2.3. Manufacture	29
4.2.4. Power Supply	30
5. Costs.....	30
6. Future Work.....	30
Appendix A: Forces on the coils.....	32
Appendix B: Coil cost estimates.....	39

Table of Figures

Figure 1: Requested field map at $y=0$	6
Figure 2: Initial steel coordinates.....	8
Figure 3: A graph showing the BH curves for the considered materials. The data for the GO and NGO steels has been adjusted to account for the lamination packing factor. The BH curve of US1010 was measured after the iron had been annealed. Mild steel is shown for comparison.	10
Figure 4: Maximum magnetic flux density generated in US1010 and GO steel from varying coil size in C0 (2 cm gap).	11
Figure 5: B_y variation with y in the outer steel in Magnet C8 where US1010 is used- top figure indicates the location of the plot shown below it.	12
Figure 6: Blending corners on the yoke of early C0 concept - B_y fields in the XY plane at $z=0$: baseline model (top) and modified yoke (below), coil shown in red and steel shown in green with superimposed B_y -field map.....	13
Figure 7: Intended magnetic flux path on standard SHiP muon filter magnets on left, flux path in C0 with inner and return yoke in contact on right.....	14
Figure 8: Magnet scenarios for Magnet C0: No gap between inner and return -top left, 2 cm gap – top right, simplified C0 with coils in 2 cm gap – bottom (steel shown in green and coils in red).	15
Figure 9: Field profile across the gap in C0.	15
Figure 10: A diagram showing two possible coil configurations. The magnetic field is the same if each coil has the same number of amp-turns.....	16
Figure 11: Views of the Opera Vector Fields SHiP Muon Filter model.	18
Figure 12: Example field map from the SHiP Muon Filter model at $y=0$	19
Figure 13: Location of steel (blue) with respect to the field map of B_y at $y=0$ (30 cm gap on left and 10 cm gap on right)	20
Figure 14: B_y fields around the gap between A0 and B0 (30 cm gap on left and 10 cm gap on right). 20	
Figure 15: $ B_y $ fields above 1.75 T in the region around the gap between A0 and B0 (30 cm gap on left and 10 cm gap on right).....	21
Figure 16: The location of the hadron stopper relative to the magnets.	21
Figure 17: Location of hadron stopper (lime green) and magnet A0 (steel in blue and coil in red).....	22
Figure 18: B_y field at $y=0$ in the region of the hadron stopper and A0.	22
Figure 19: B_y field above 1.8 T at $y=0$ in the region of the hadron stopper and A0.	23
Figure 20: Force vector diagram for coil A0 with GO steel - maximum force of 0.7 N.....	24
Figure 21: A cross-section of a magnet. The yoke is shown in blue, the coil is shown in red, and the flux is shown in green. The current in the coil is normal to the page.....	25
Figure 22: Interleaved joints. The arrows represent the grain orientation of the steel.....	26
Figure 23: Mitred joints. The arrows represent the grain orientation of the steel.	26
Figure 24: Example of stepped fields in magnet B0 to simplify the manufacturing process (desired field at $y=0$, the blue and green regions indicate the positive and negative 1.8 T B_y fields respectively).....	27

Active Muon Shield
Preliminary Magnet Design Report

Figure 25: A diagram showing the different ways of aligning the laminations. The diagram on the left is the orientation that has been modelled. 27

Figure 26: A0 with GO steel – maximum force 0.7 N..... 32

Figure 27: B0 with GO steel – maximum force 1.1 N..... 33

Figure 28: C0 with GO steel – maximum force 0.3 N..... 34

Figure 29: C4 with GO steel – maximum force 2.7 N..... 35

Figure 30: C6 with GO steel – maximum force 2.3 N..... 37

Figure 31: C7 with GO steel - maximum force 2.6 N..... 37

Figure 32: C8 with GO steel– maximum force 5.7 N..... 38

1. Introduction

This report summarises the initial design study which was carried out for the SHiP magnetic muon filter – which is proposed to consist of a 40m beamline of seven magnets generating a 1.8T B_y field over defined cross-section. This is intended to sweep unwanted muons off the beamline to prevent them reaching the detector. The magnetic shield is an alternative to a passive tungsten shield. The passive tungsten shield was estimated to require ~ 10 MCHF (€9.5M) of material and did not satisfactorily shield the detector¹.

This work was carried out in three sections. Initially the magnets were considered in isolation to establish whether they were theoretically feasible to build and the impact of the iron yoke shape and material was considered. Next the beamline was considered as a whole; this included issues such as the impact of neighbouring magnets and the hadrons stopper, and also building a model of the complete beamline whose magnetic fields could be exported for use in particle modelling. Finally, some consideration was given to the manufacture and operational issues, including costs.

It is shown that the desired magnetic field could feasibly be built, a complete finite element model has been built and exported for use in further modelling and some estimated costs are given.

1.1. Specification

The starting point for this design study was the field map shown in Figure 1. This is a cross-section of the desired B-field at $y=0$ m; the blue and green regions indicate positive and negative 1.8 T B_y fields respectively. The behaviour of some muons is also indicated. In addition to this field map, some coordinates were given to indicate the approximate location of the steel in three dimensions. These are shown in Figure 2. The magnet naming convention is given in Table 1 below. The range of z-locations used in Figure 1 (0m to 48m) is equivalent to the z-locations used in Table 1 (-83m to -35m); the discrepancy is due to the different models used within the project – the Opera model described below uses the naming convention described in Table 1.

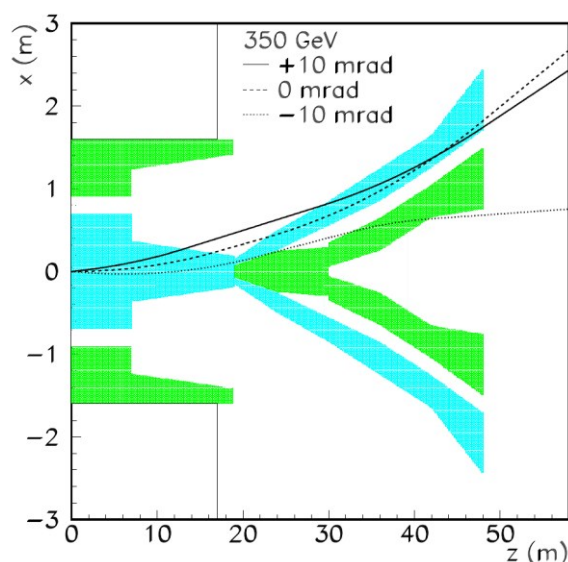

Figure 1: Desired field map at $y=0$.

¹ 'Muon Shield', Mitesh Patel (Imperial College London) 15th Jan 2015, 2015-01015 Ship_General_Meeting_update.pdf

Active Muon Shield
Preliminary Magnet Design Report

The required magnets will have a number of novel aspects.

- Unlike particle accelerator magnets, there is no air gap. This greatly reduces the magnetomotive force required to obtain a given flux density.
- Unlike a transformer, the magnet is operated with DC coils. This means that there will be no losses due to eddy currents and hysteresis. The only loss is the Joule heating in the coils.
- The magnets are very large and it may be difficult to find the facilities to produce the coils. Their large size means that designing the support structure may be challenging.
- The required cross section of the iron is not constant along z which will make manufacture more difficult.

Magnet Name	Z-location (m)
A0	-76 to -83
B0	-64 to -76
C0	-59 to -64
C4	-53 to -59
C5	-41 to -53
C7	-47 to -41
C8	-41 to -35

Table 1: Magnet naming convention

1.2. Modelling

The modelling was done in two stages. The first stage focused on demonstrating that these magnets could realistically be built and could achieve the desired field profile. This was done by modelling two specific magnets in isolation (roughly equivalent to magnets A0 and C4 in the new configuration shown above) and investigating the material options and yoke and coil geometry. The second phase focused on building a complete model of the muon shield so that the field maps could be exported for use in other simulations – this was initially done using grain-orientated (GO) steel, and then a variation was done using a soft iron, US1010. All modelling was carried out using Cobham Opera software.



CERN-SHIP-PUB-2015-003
26 June 2015

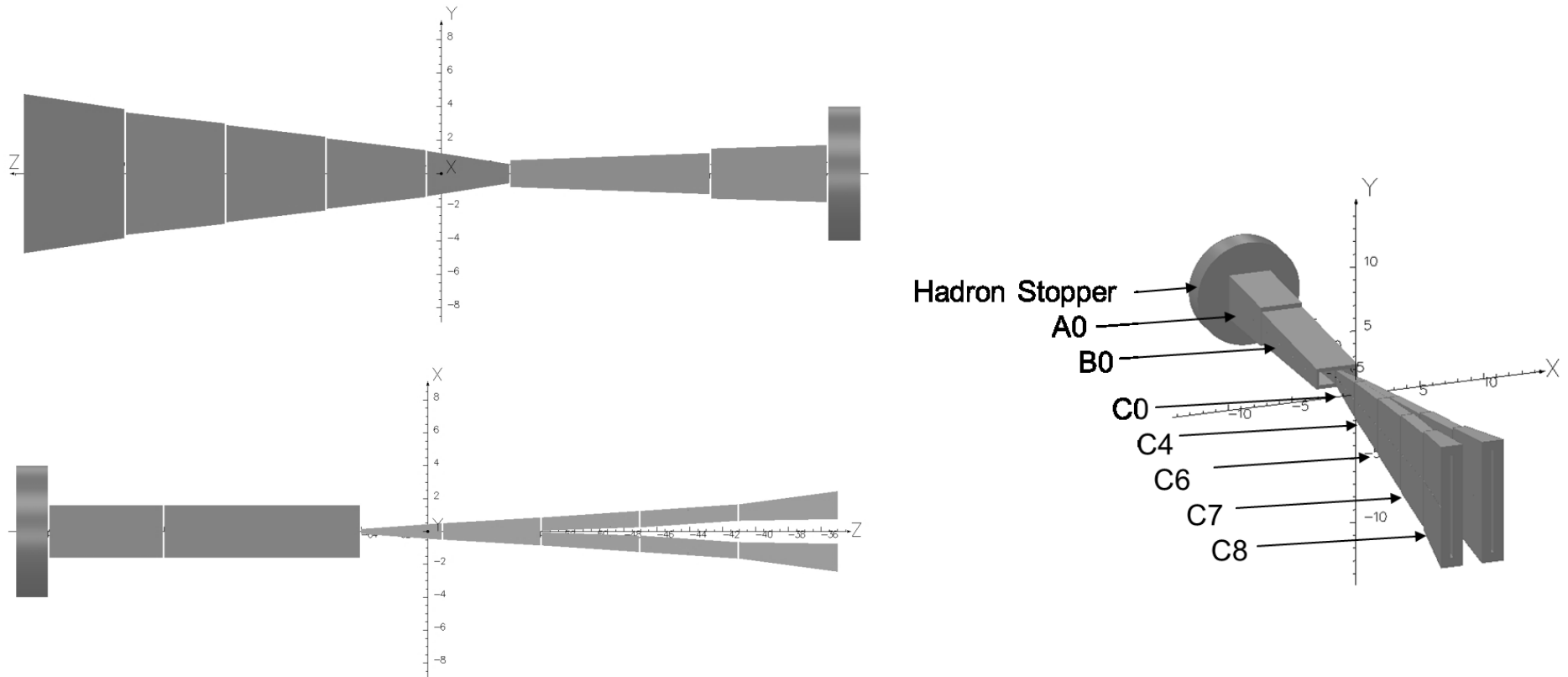

Figure 2: Initial steel coordinates



2. Preliminary Modelling

This section summarises the early work done to establish that feasibility of building the magnets; issues such as the core material choice, the coil location and the yoke geometry are considered.

2.1. Material Selection

Three different materials were considered for the manufacture of the yokes: soft iron, non-grain orientated (NGO) electrical steel and grain orientated (GO) electrical steel.

Soft iron is commonly used in small DC magnets. It comes as a solid block which is then machined into shape. US1010 grade will be used for modelling soft iron throughout this report.

NGO and GO steel are commonly used in transformers and large accelerator magnets. They are sold as sheets which have been coated with an insulating layer. The sheets are available in a range of thicknesses up to ~1 mm. To make a magnet, the sheets are cut, stacked, and clamped together. NGO and GO steels are manufactured slightly differently, GO steel is processed in such a way that the crystalline structures within the steel are aligned. This produces very high permeability in the rolling direction but lower permeability in other directions. NGO steel is processed so that the permeability is isotropic.

The materials are summarised in Table 2.

Material	Advantages	Disadvantages
Soft Iron	<ul style="list-style-type: none">• The blocks make assembly easier• Quite high permeability• Can withstand high levels of magnetic field without saturating• Quite cheap	<ul style="list-style-type: none">• The magnetic properties are very dependent on how it was cast and may vary between batches
NGO Steel	<ul style="list-style-type: none">• Quite high permeability• Very consistent magnetic properties	<ul style="list-style-type: none">• Laminations make it more difficult to assemble
GO Steel	<ul style="list-style-type: none">• Very high permeability in rolling direction• Very consistent magnetic properties	<ul style="list-style-type: none">• Laminations make it more difficult to assemble• Poor permeability perpendicular to the rolling direction.• More expensive than NGO steel

Table 2: A trade-off of different yoke materials.

Active Muon Shield
Preliminary Magnet Design Report

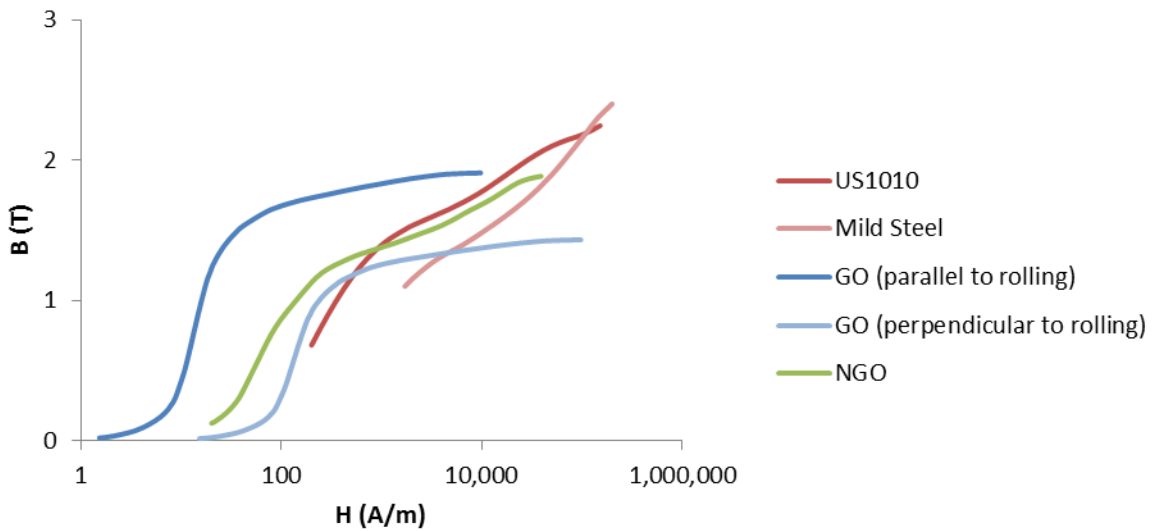
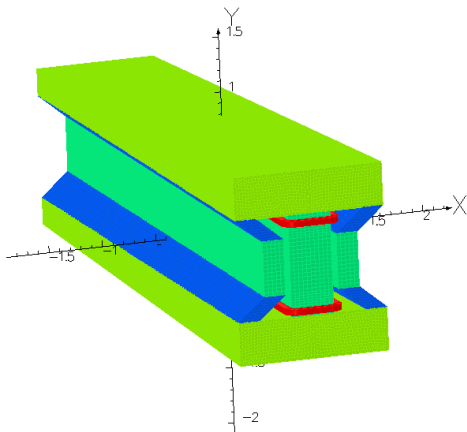

Figure 3: A graph showing the BH curves for the considered materials. The data for the GO and NGO steels has been adjusted to account for the lamination packing factor. The BH curve of US1010 was measured after the iron had been annealed. Mild steel is shown for comparison.

An initial study showed that the flux density, B , is strongly affected by the choice of material. Table 3 shows the variation in flux density when using different materials with the otherwise same coil and yoke.



Material			B_y field in centre at $y=0$ (T)
Lime Green	Blue	Turquoise	
US1010	US1010	US1010	1.72
Mild Steel	Mild Steel	Mild Steel	1.47
NGO	NGO	NGO	1.69
US1010	US1010	GO	1.84
US1010	GO	GO	1.86

Table 3: Effect of material choice on flux density in early CO concept.

If a high permeability material such as GO steel is used, fewer amp-turns would be required to achieve the desired flux density. The coils would be made smaller (with therefore lower material costs), would use less power and generate less heat. Air cooling, rather than water cooling, could be used because of the reduced heat generation – this would further reduce the running costs while also improving reliability.

In some magnets, the effect of the yoke material on the required amp-turns is particularly apparent.

Active Muon Shield
Preliminary Magnet Design Report

Figure 4 shows the B_{\max} generated from coils of various sizes in magnet C0; it can be seen that when GO steel is used in part of the magnet, 5,000 amp-turns are needed to get a peak flux of 1.8 T. In comparison the peak field in a completely US1010 steel magnet with 100,000 amp-turns is just over 1.7 T.

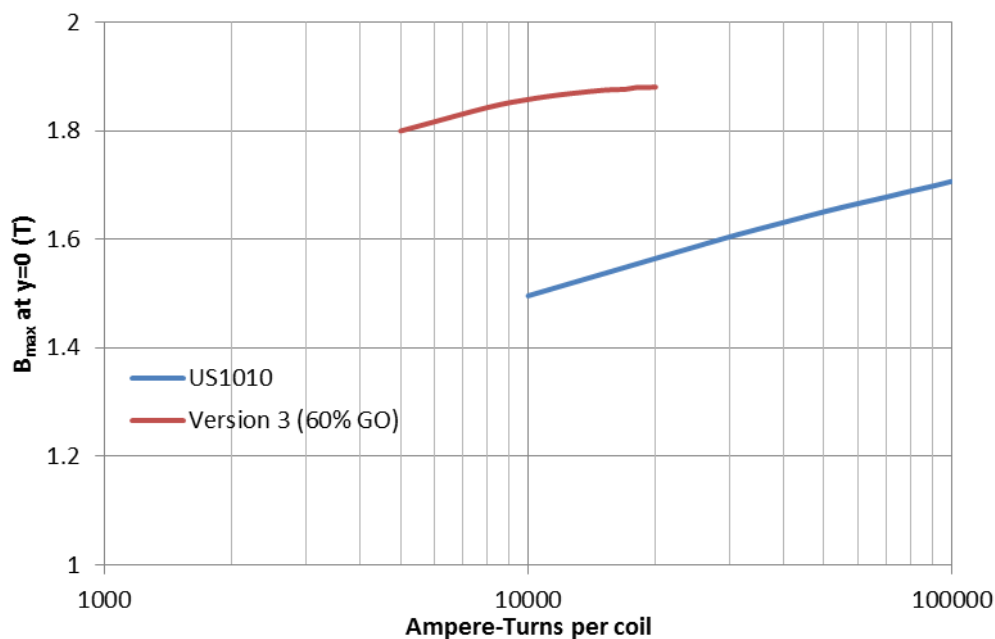

Figure 4: Maximum magnetic flux density generated in US1010 and GO steel from varying coil size in C0 (2 cm gap).

Another factor in deciding which steel to use is the field quality. The magnetic flux is better contained within the GO steel because of the higher permeability, so the variation in field in the iron is less than if US1010 is used. Figure 5 shows the variation in B_y over y in the outer steel in magnet C8 when US1010 is used; it can be seen that $1.2 < B_y < 1.9$ T. In comparison $1.80 < B_y < 1.82$ T where GO steel is used.

GO steel has much better magnetic properties than soft iron; however soft iron magnets would have lower material and manufacturing costs. The simple cost comparison for the two systems is discussed in more detail in Section 5. A full beamline has been modelled for both GO steel and soft iron (see section 3). It is recommended that a detailed study should be carried out to trade-off the extent to which GO steel is used, taking into consideration the field requirements and the costs.

Active Muon Shield Preliminary Magnet Design Report

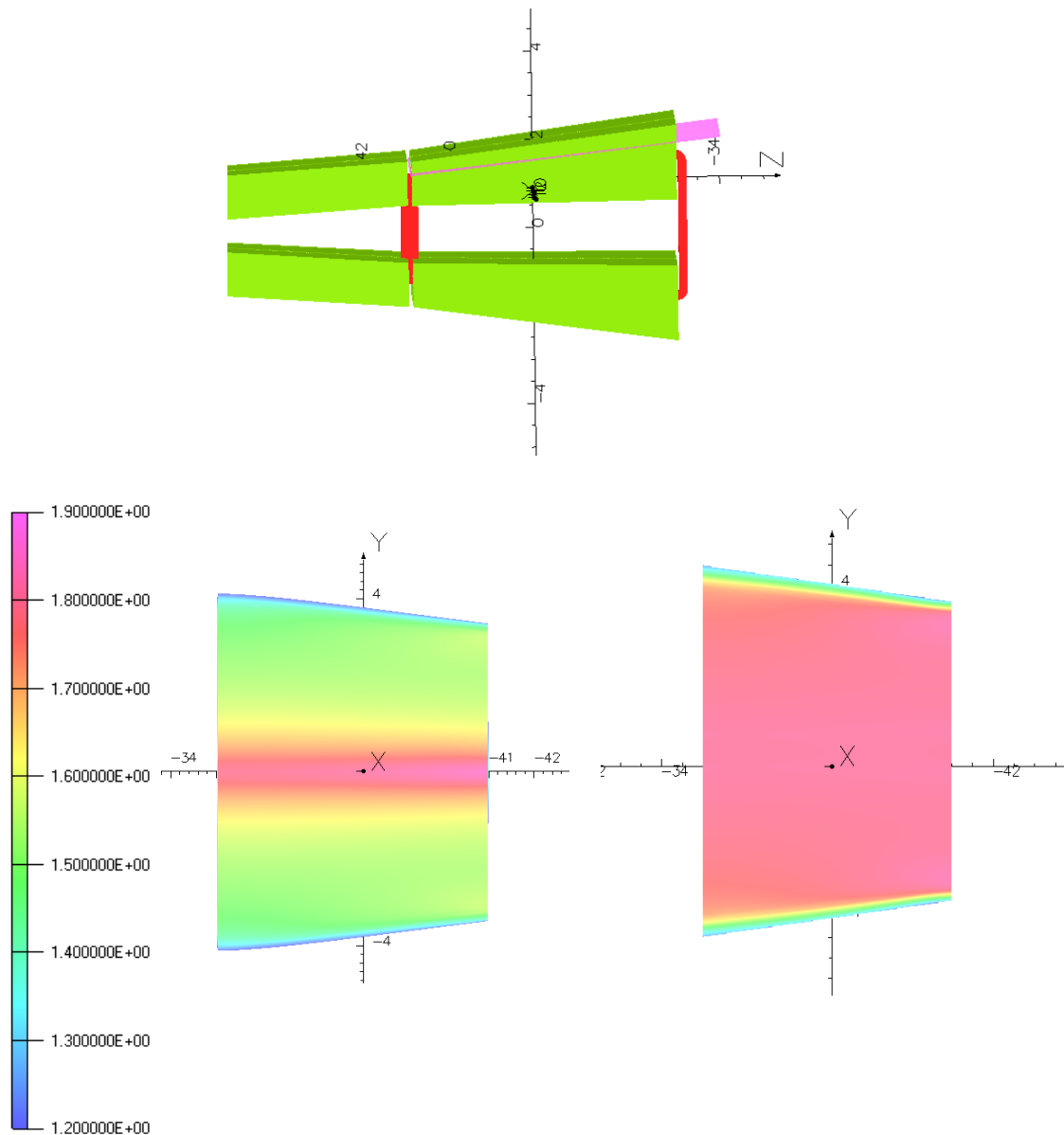

Figure 5: B_y variation with y in the outer steel in Magnet C8 with US1010 (bottom left) and with GO steel (bottom right); top figure indicates the location of the plot shown below it.

2.2. Yoke optimisation

2.2.1. C0 Yoke Shape

Optimising the shape of a soft iron yoke can reduce peak fields (and therefore reluctance) in the iron and thereby prevent flux from jumping across the air gap. Some optimisation was tried on an early concept of magnet C0 – in this case it was found that by blending corners on the yoke, the B_{\max} at $y=0$ increased from 1.49 T to 1.52 T, an increase of 2 %. There are still areas of high flux, shown in Figure 6, which optimisation of the yoke shape could further reduce. Optimisation of the yoke could therefore be used to reduce the power needed in the coils, although it should be noted that particularly complex shapes could be harder to manufacture and therefore more expensive.

Active Muon Shield Preliminary Magnet Design Report

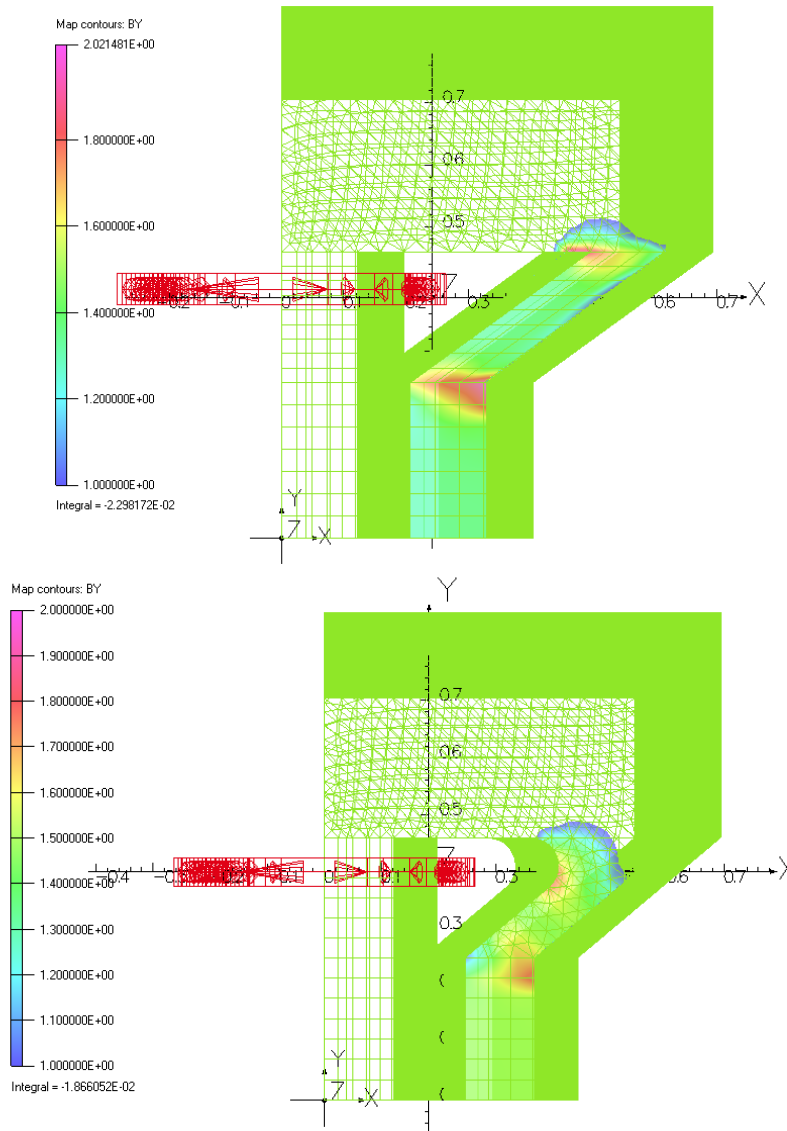

Figure 6: Blending corners on the yoke of early C0 concept - B_y fields in the XY plane at $z=0$: baseline model (top) and modified yoke (below), coil shown in red and steel shown in green with superimposed B_y -field map.

2.2.2. Gap between centre and return field – C0 and C4

The initial field map specified that the centre and return fields should be in contact in magnet C0. This is represented by the 'Ideal' field profile shown in Figure 9. However, this is not possible to achieve. If the iron yokes for the centre and return fields are touching then there is nothing to stop the flux jumping from the outer to the inner yoke without going around the whole circuit, as shown in Figure 7.

Active Muon Shield
Preliminary Magnet Design Report

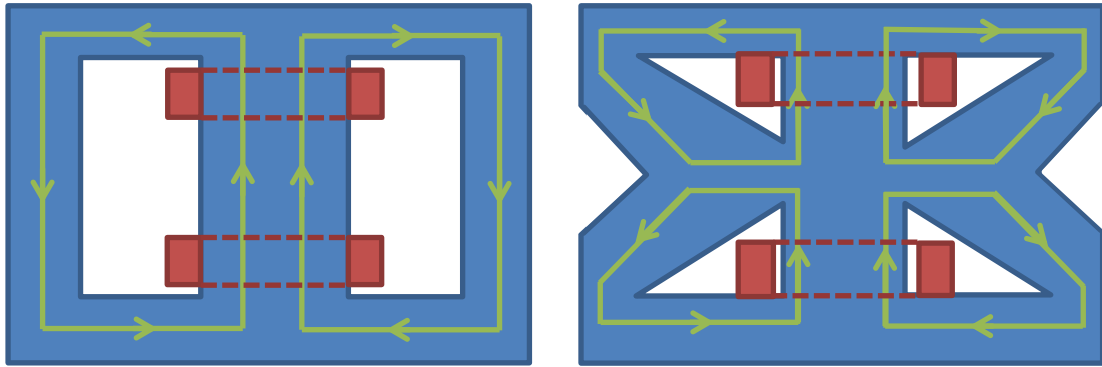

Figure 7: Intended magnetic flux path on standard SHiP muon filter magnets on left, flux path in C0 with inner and return yoke in contact on right.

Three scenarios for this magnet have been modelled (all use GO steel):

- No gap between the inner and outer steel
- A 2 cm gap between the inner and outer steel
- A 2 cm gap between the inner and outer steel, with a simplified overall shape

The field profiles generated from the first two scenarios are also shown in Figure 9 for comparison. In the scenario with no gap, there is a gradual transition between the positive and negative field values over a width of 25 cm. In the scenario with the 2 cm gap, it can be seen that the area of maximum field extends to the edge of the steel in both the inner and outer steel, with a 2 cm area of 0 T separating them. Therefore, a small gap gives the closest match to the desired profile.

Active Muon Shield
Preliminary Magnet Design Report

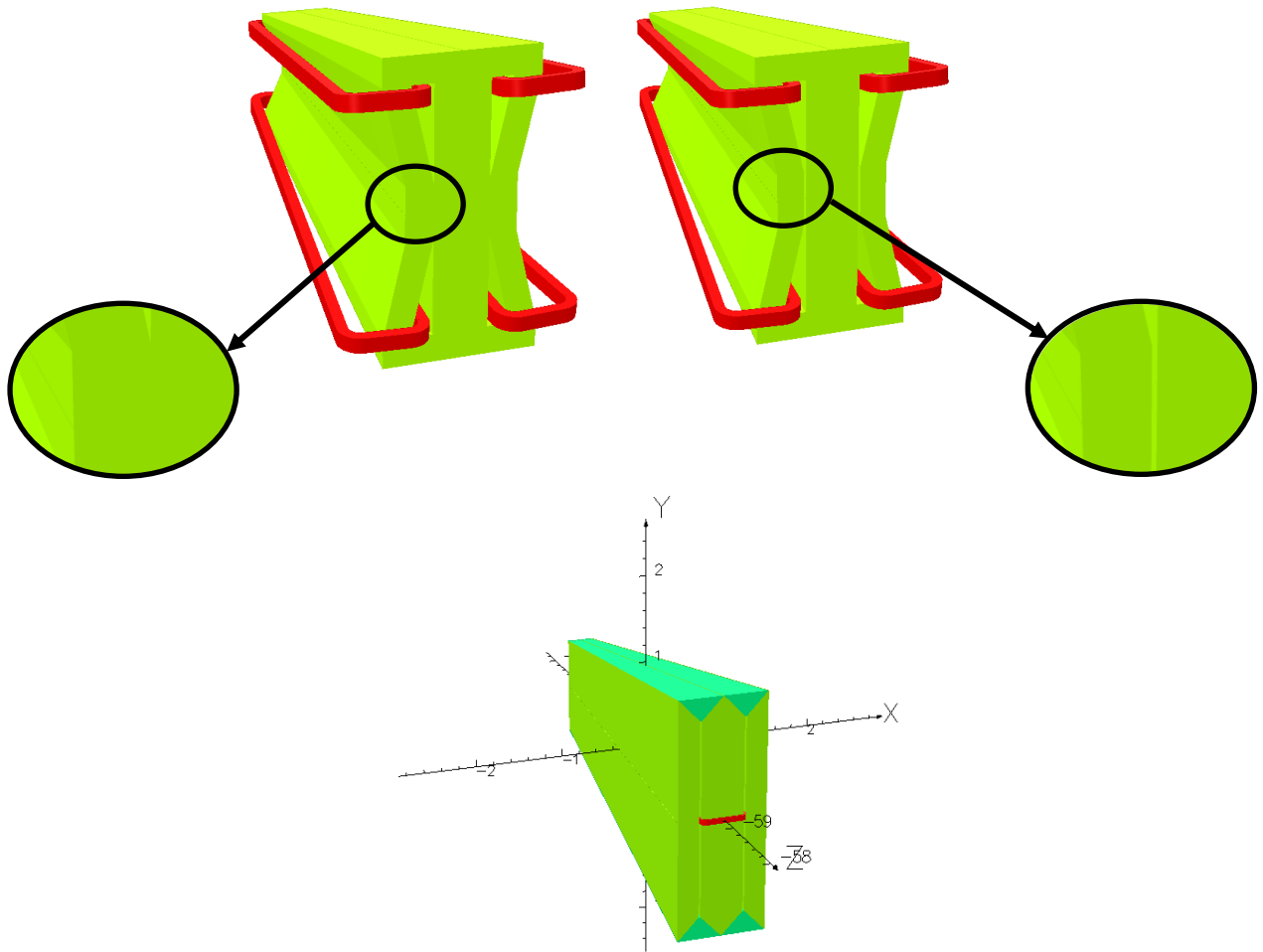

Figure 8: Magnet scenarios for Magnet C0: No gap between inner and return - top left, 2 cm gap – top right, simplified C0 with coils in 2 cm gap – bottom (steel shown in green and coils in red).

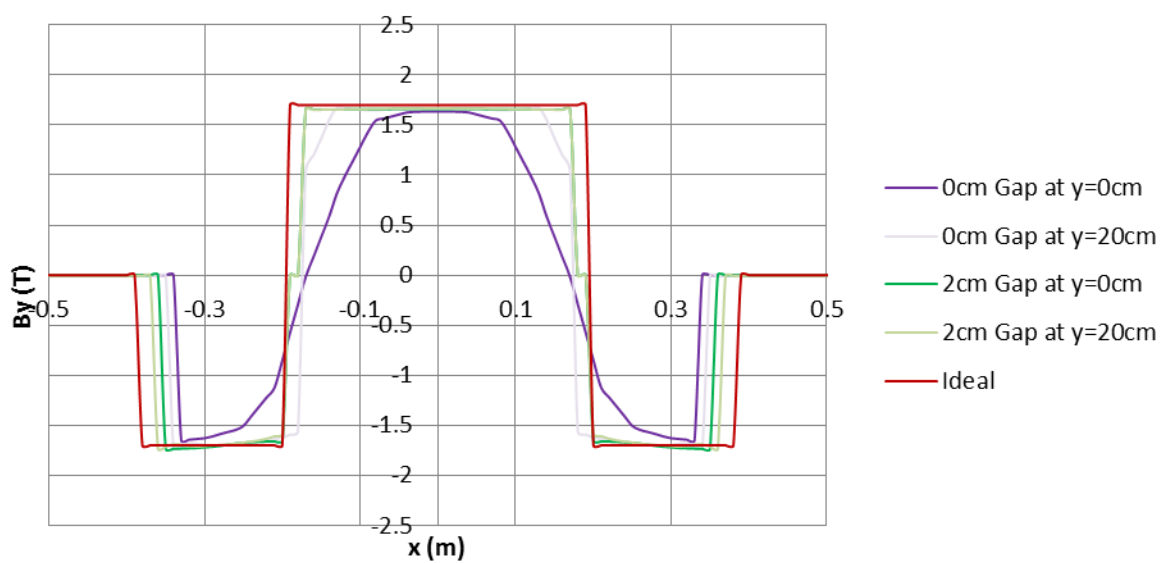

Figure 9: Field profile across the gap in C0.

2.3. Coil Location

2.3.1. Radiation²

Initial estimates suggest that the radiation levels will be quite low. The first magnet will experience a maximum dosage of 20 kGy. The radiation dosage will be lower for the other magnets. Since 1 MGy is the beginning of radiation damage to epoxy, the radiation does not impact the choice of the coil location.

2.3.2. Effect on Flux

There are two factors to consider when looking at the effect of the coil location on the flux density.

For an unsaturated yoke, with an inner leg twice the cross sectional area of the outer legs, the same magnetic field is achieved if one coil is placed around the inner leg or if two coils are placed around the outer legs, with each coil having the same number of amp-turns. Therefore, for identical coils, a magnet with a coil around the inner leg has half the power requirement of a magnet with a coil around each of the outer legs.

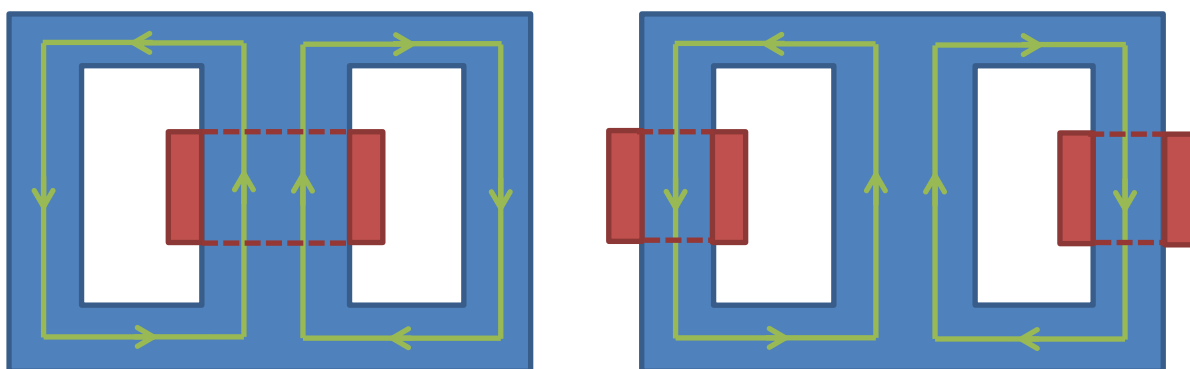

Figure 10: A diagram showing two possible coil configurations. The magnetic field is the same if each coil has the same number of amp-turns.

The other factor is that the magnetic field becomes more dependent on the position of the coils when the iron is approaching saturation. In some of the SHiP magnets, a high field strength is only required in the outer legs. Therefore, it may be necessary to put the coils on the outer legs to achieve the required field if the iron is saturated.

An example of the variation in the field strength between the inner and outer legs, based on coil placement and material is given in Table 4. It can be seen that where GO steel is used, the inner and return fields are very similar, but where US1010 is used, the field is 0.09 T lower in the outer steel.

² E-mail, Marco Calviani, 11/03/2015

Active Muon Shield
Preliminary Magnet Design Report

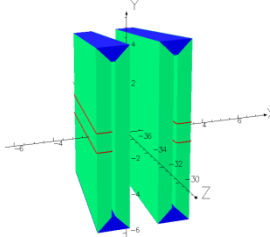
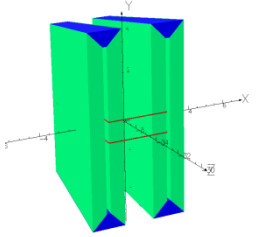
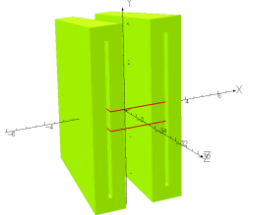
C8 Variation	Conductor Size (amp-turns per coil)	Total Conductor Size (total amp-turns)	Inner B_y (T)	Outer B_y (T)
 <ul style="list-style-type: none"> • Grain-orientated steel. • Coils around outer. 	1,500	6,000	1.80	1.81
 <ul style="list-style-type: none"> • Grain-orientated steel. • Coil around inners. 	1,100	2,200	1.80	1.79
 <ul style="list-style-type: none"> • US1010. • Coil around inner. 	65,000	130,000	1.89	1.80

Materials Key

- Conductor
- Steel (GO vertical)
- Steel (US1010)
- Steel (GO horizontal)

Table 4: Coil placement.

3. Beamline Modelling

Each of the magnets was first modelled in isolation and the coil position and amp-turns was adjusted to achieve the required field. Once the required field had been achieved for each magnet, they were combined into a full beamline model.

Figure 11 shows the complete model of the beam and Figure 12 shows a field map from one of the simulations. It can be seen that while some design work could be done to optimise the magnets, they are essentially able to generate the desired field map (shown in Figure 1).

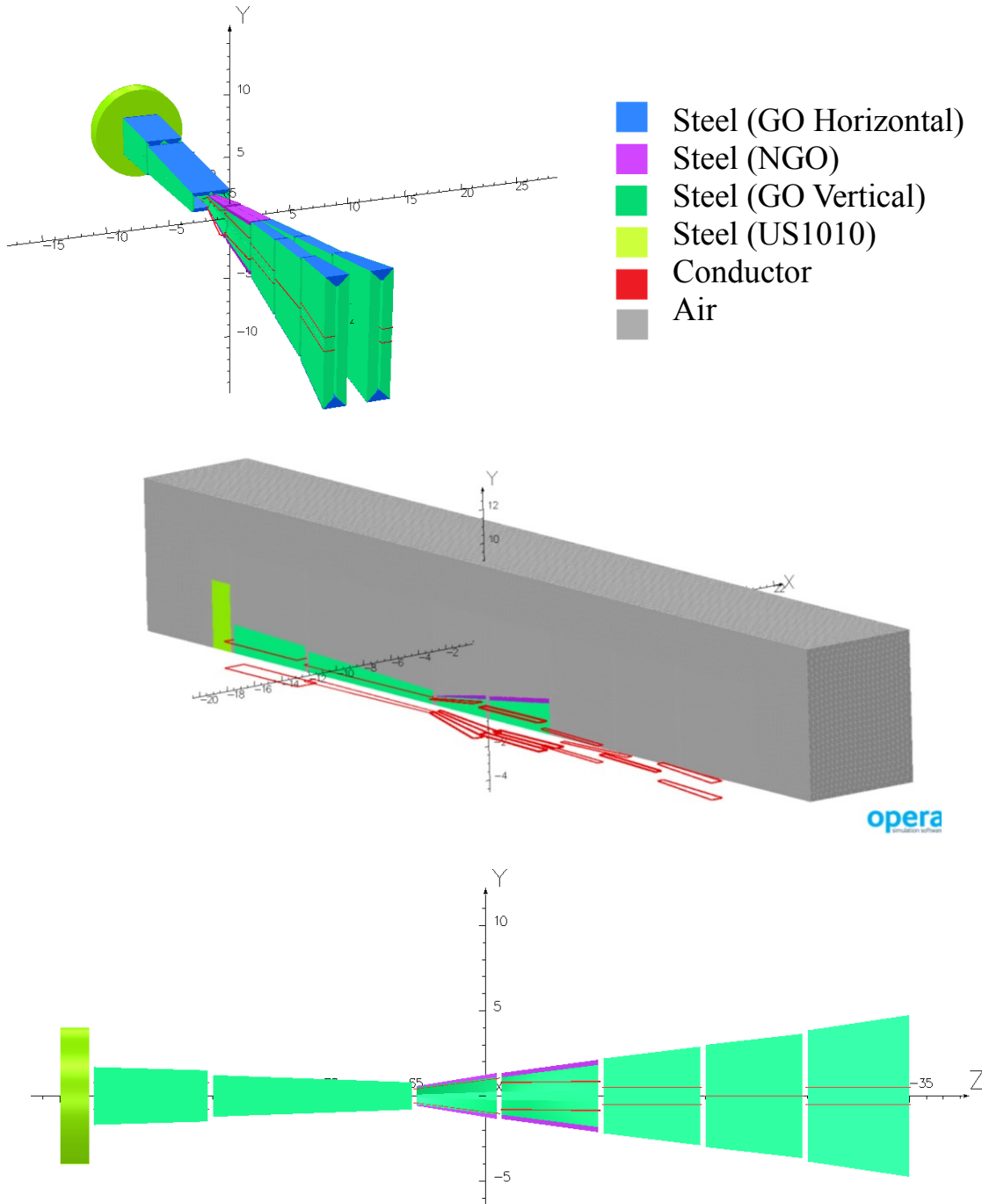

Figure 11: Views of the Opera Vector Fields SHiP Muon Filter model.



CERN-SHiP-PUB-2015-003
26 June 2015

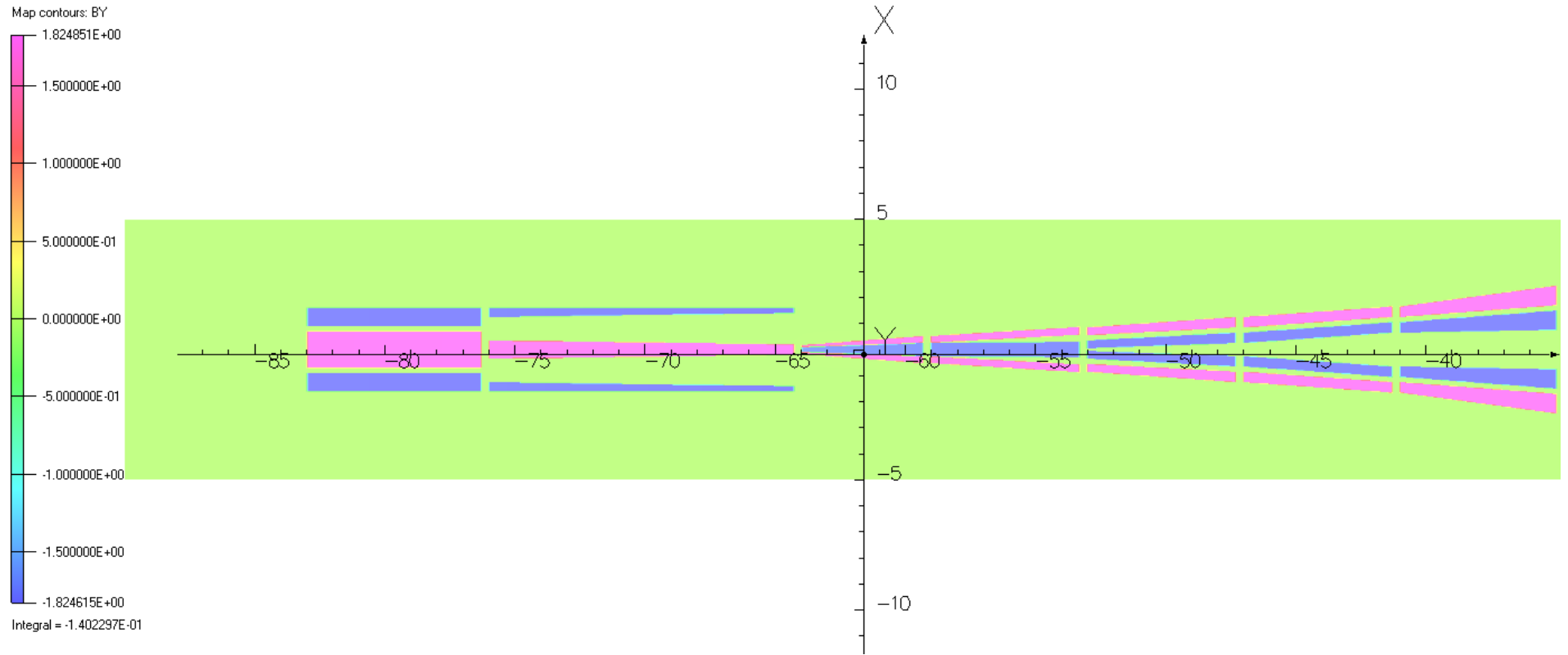

Figure 12: Example field map from the SHiP Muon Filter model at $y=0$.



3.1.Spacing between magnets along the beamline (z-axis)

Ideally there would be no space between neighbouring magnets but in reality it is easier to allow a short gap between the magnets to allow for the placements of the coils (it is much easier to manufacture a racetrack coil than a bedstead coil). Initially it was assumed that a 300 mm gap would be required but this was reduced in later models to 100 mm. The plots below compare the fields between magnets A0 and B0 in either case – it can be seen that with this separation, the magnets do not affect each other.

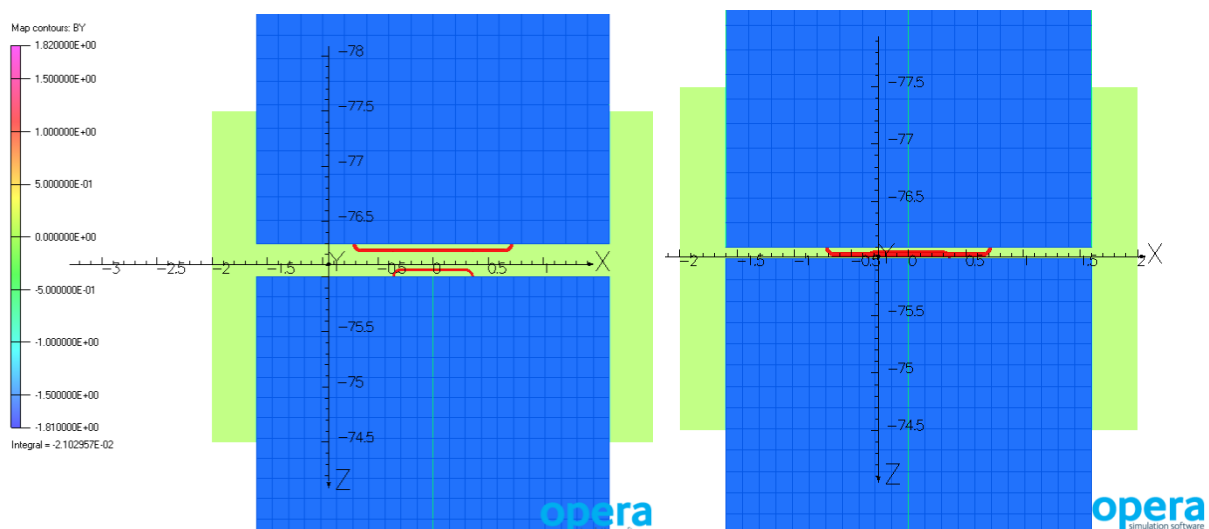

Figure 13: Location of steel (blue) with respect to the field map of B_y at $y=0$ (30 cm gap on left and 10 cm gap on right)

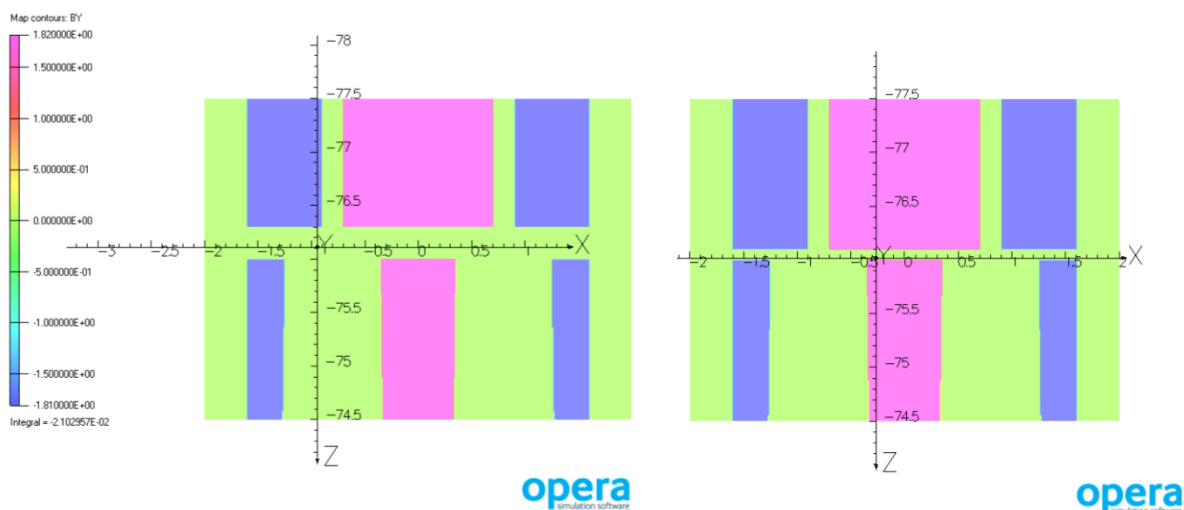

Figure 14: B_y fields around the gap between A0 and B0 (30 cm gap on left and 10 cm gap on right).

Active Muon Shield Preliminary Magnet Design Report

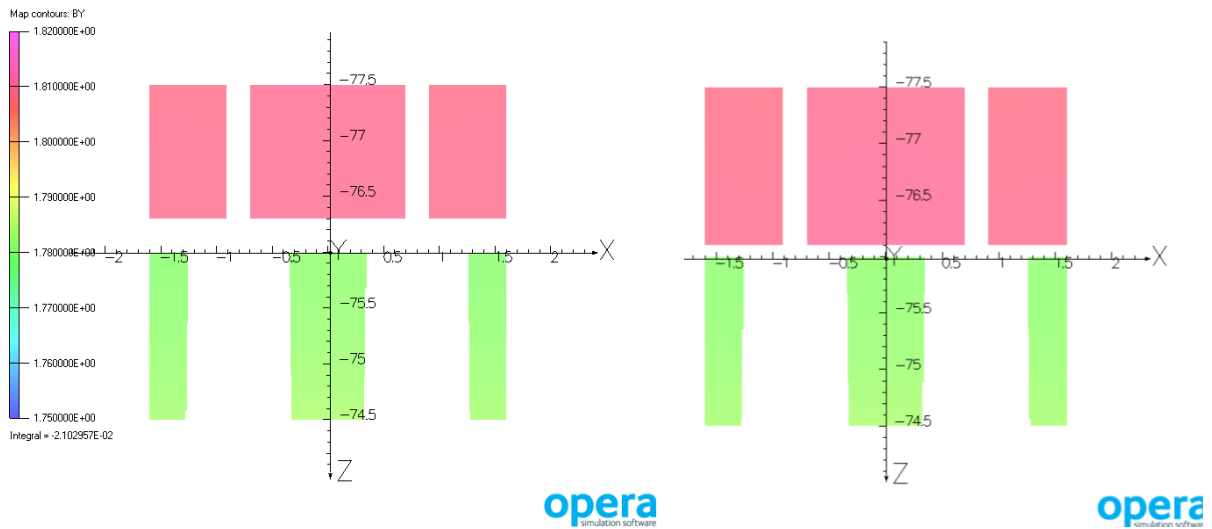

Figure 15: $|B_y|$ fields above 1.75 T in the region around the gap between A0 and B0 (30 cm gap on left and 10 cm gap on right).

3.2. Hadron stopper

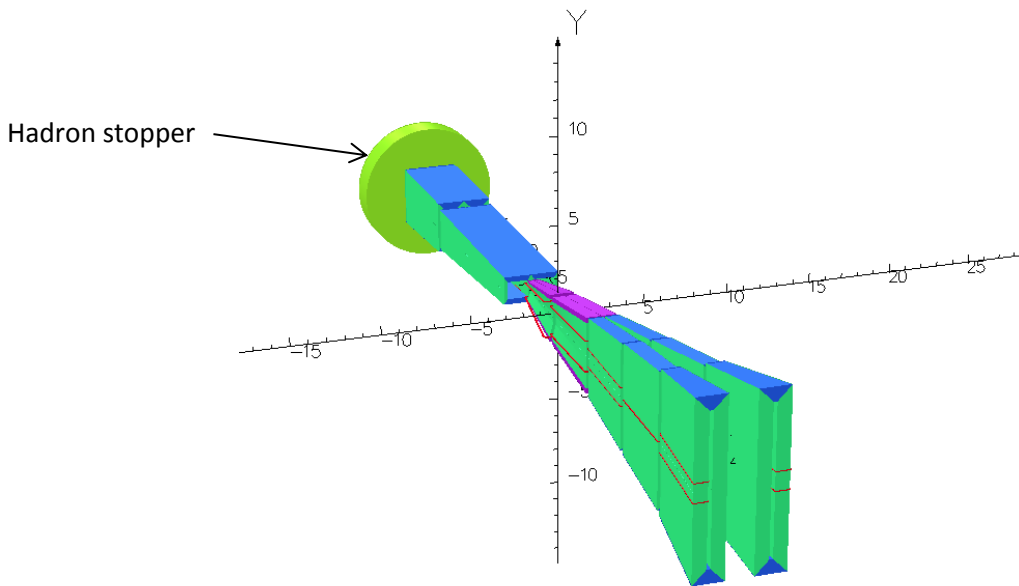

Figure 16: The location of the hadron stopper relative to the magnets.

The question arose of whether making Hadron Stopper out of a mild steel would adversely affect the flux in the muon filter. The plots in Figure 17, Figure 18 and Figure 19 show the location of the steel in the region in question and the resulting magnetic fields. In this case the hadron stopper was modelled from US1010 (as being the worst case scenario) and it can be seen from the plots that it has a negligible effect on the fields in magnet A0.

Active Muon Shield Preliminary Magnet Design Report

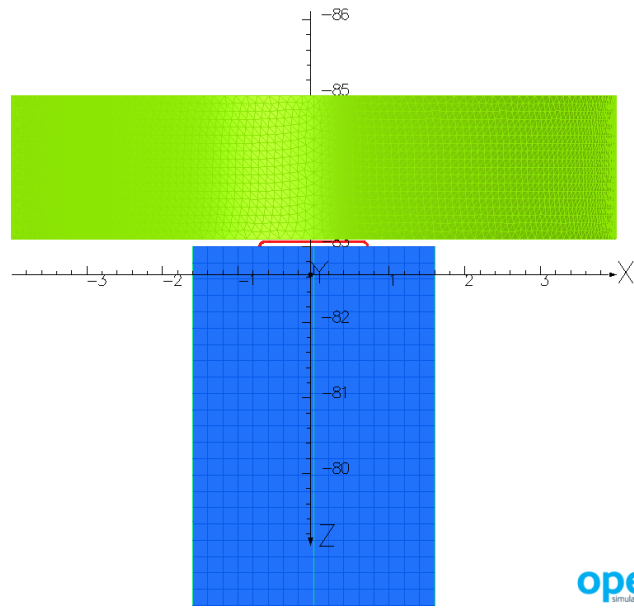

Figure 17: Location of hadron stopper (lime green) and magnet A0 (steel in blue and coil in red).

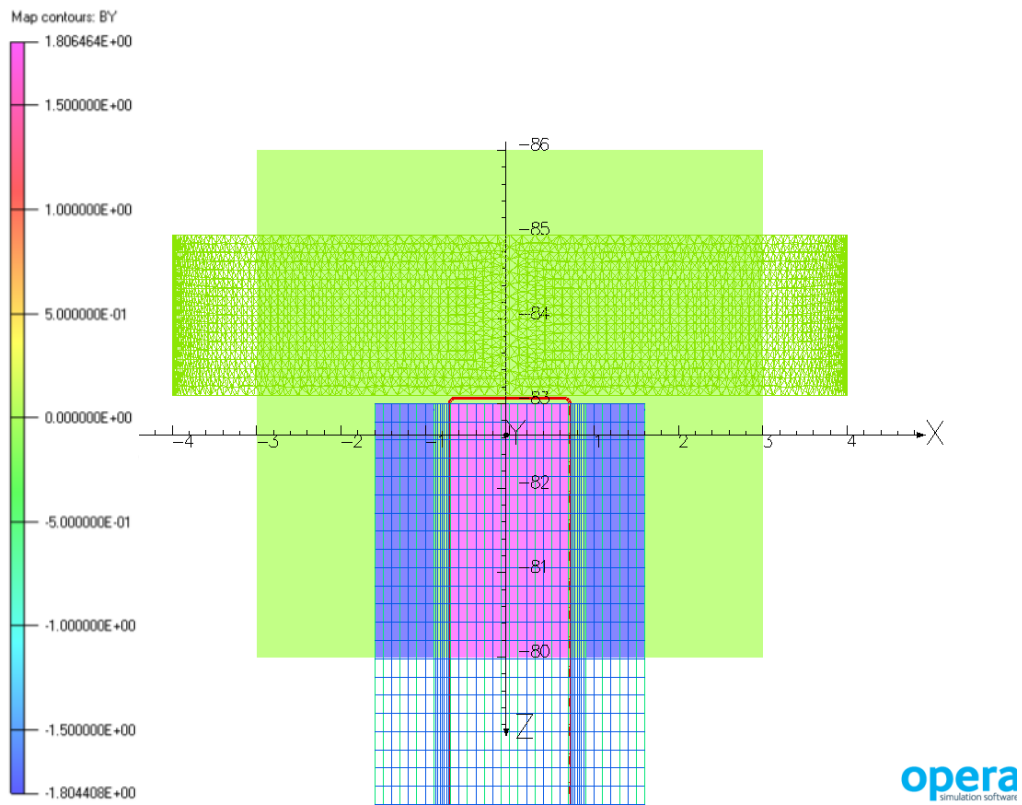

Figure 18: B_y field at $y=0$ in the region of the hadron stopper and A0.

Active Muon Shield Preliminary Magnet Design Report

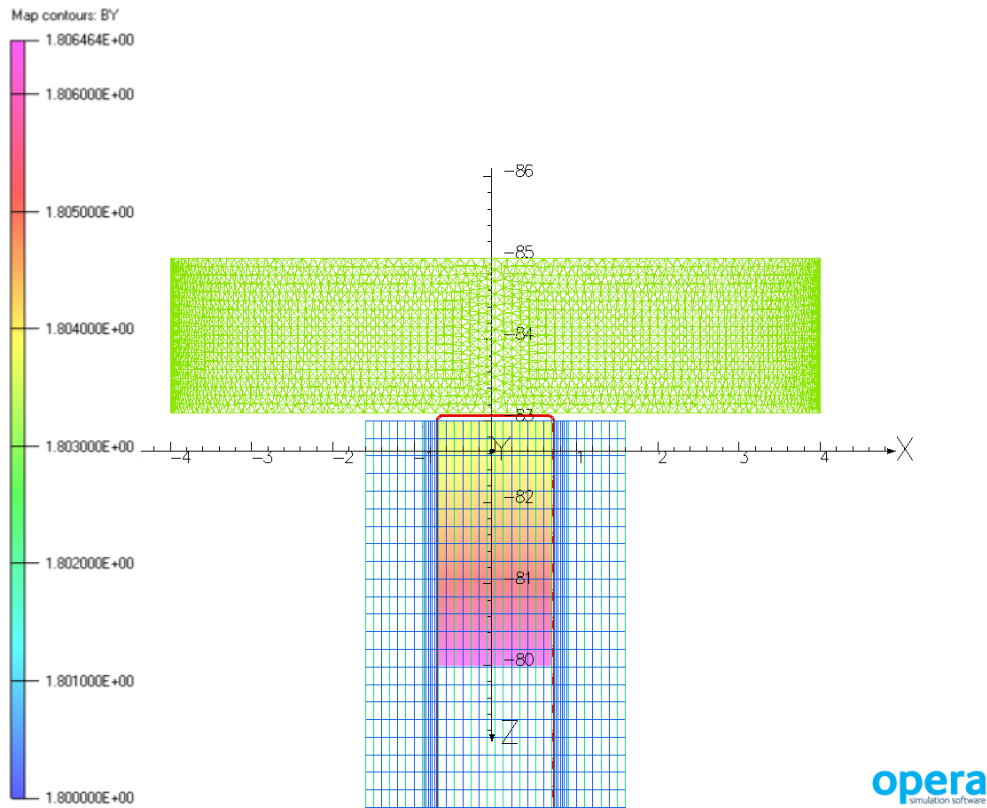

Figure 19: B_y field above 1.8 T at $y=0$ in the region of the hadron stopper and A0.

3.3. Force on coils

An initial look at the forces on the coils and between the steel yoke predicts them to be dramatically different depending on whether GO steel or US1010 is used – the forces in the US1010 model are significantly higher. This is a combination of the fact that there are more Amp-turns used in the US1010 magnets and also that, with GO steel, the flux is well-contained in the steel so there is only very low magnetic flux between the magnets and around the coils to generate forces. In the GO steel model, the maximum total force in y on any magnet is 55 N on the C8 coil, and the maximum force density on any coil is 3.4 N/m on magnet A0. In the US1010 model, the forces are of the order of 500-1000 times greater – for example the total y -force on A0 is 3.5 kN and the maximum force density on A0 is 2 kN/m.

The forces in the XZ plane have been visualised as vectors plotted on the coils, such as that shown in Figure 20. Similar diagrams for all the coils in the GO steel models are given in Appendix A.

Active Muon Shield
Preliminary Magnet Design Report

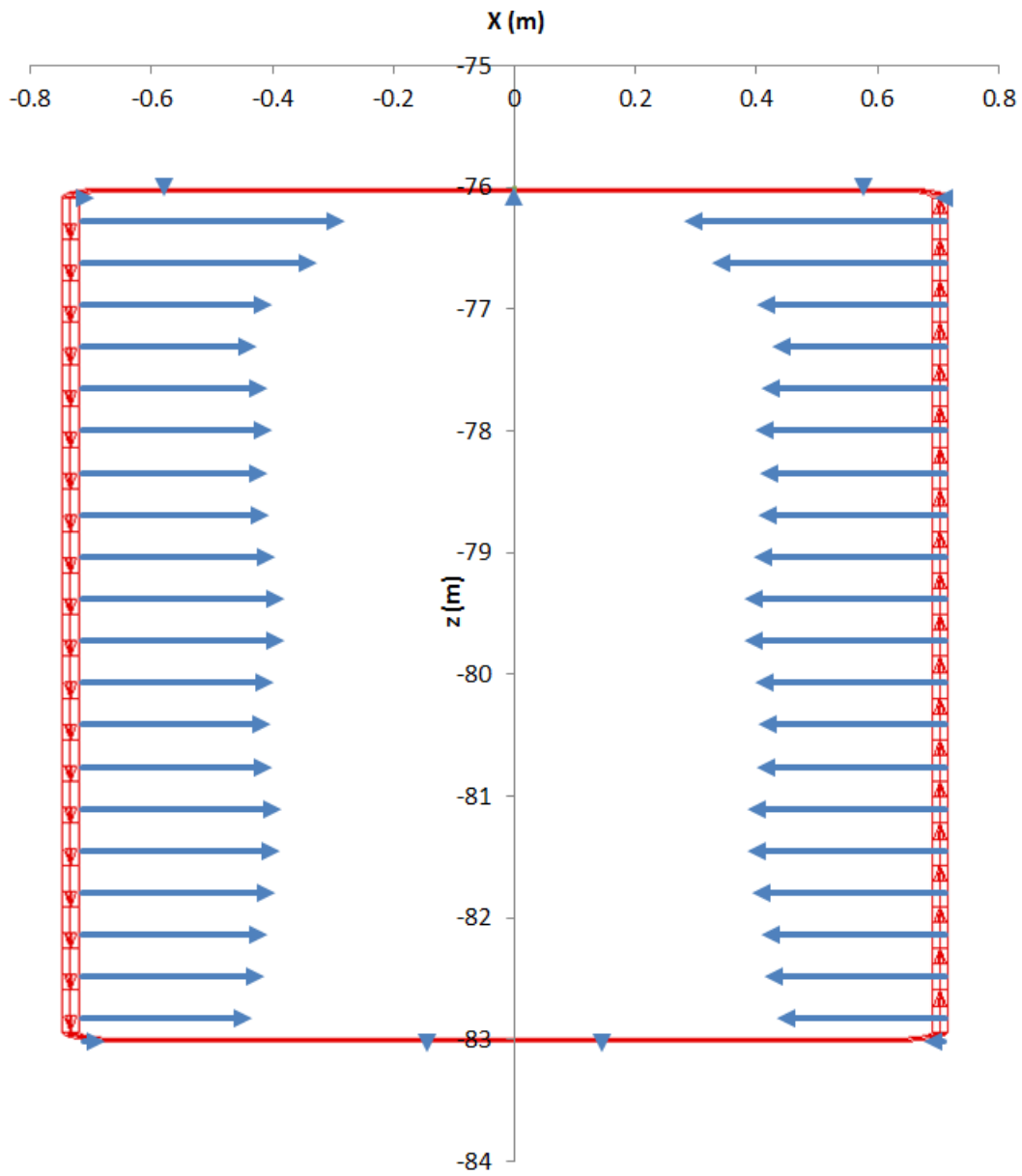

Figure 20: Force vector diagram for coil A0 with GO steel - maximum force of 0.7 N.

4. Practical Considerations

In addition to investigating whether the requested magnetic fields were theoretically achievable, some of the potential manufacturing challenges were also considered.

4.1. GO Steel Yoke

GO steel is more difficult to use as a yoke material than soft iron because it is anisotropic and is supplied in sheets.

4.1.1. Joints

At the top and bottom of each yoke, the flux will be moving horizontally and, in the middle of each yoke, the flux will be moving vertically, as shown in Figure 21. Different orientations of the steel are required in the different parts of each yoke because of the anisotropic nature of GO steel.

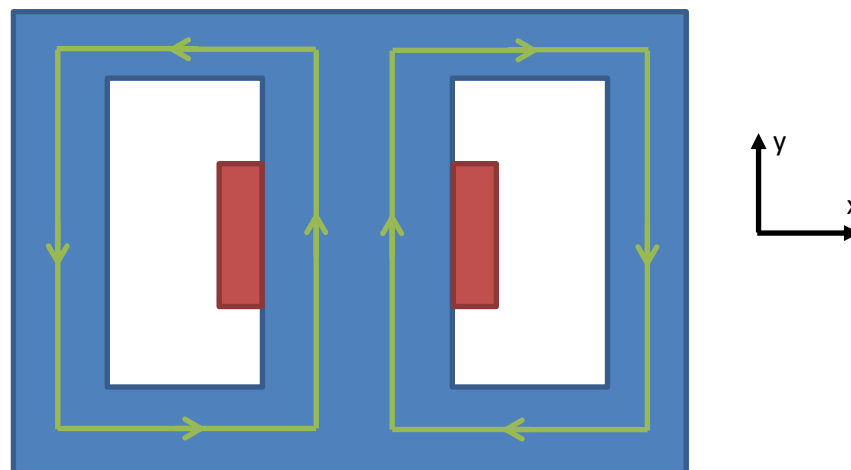

Figure 21: A cross-section of a magnet. The yoke is shown in blue, the coil is shown in red, and the flux is shown in green. The current in the coil is normal to the page.

If the magnet yokes are made from GO steel, the overall reluctance of the system is very low. This means that the joints in the steel yoke become a significant fraction of the total reluctance of the circuit, so some thought should be given to their manufacture.

There are two commonly used methods to transition between different orientations of GO steel: mitred joints and interleaved joints.³

- In interleaved joints, the sheets of steel are butted against each other. The longer side alternates between stacks. The reluctance of the joint is increased because the flux has to enter or leave the joint perpendicular to the grain orientation.

³ Transformers, BHEL, Tata McGraw-Hill, p. 100

Active Muon Shield
Preliminary Magnet Design Report

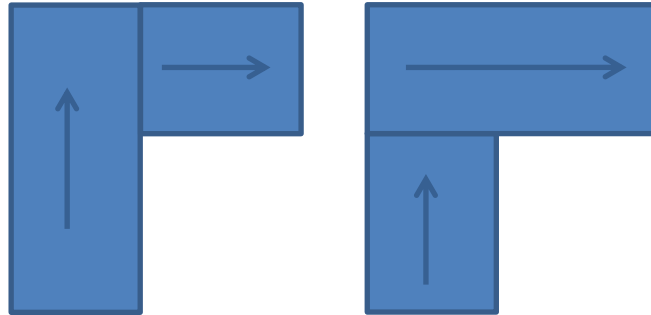

Figure 22: Interleaved joints. The arrows represent the grain orientation of the steel.

- Mitred joints are made by cutting the laminations at 45°. The flux changes direction at the joint so is always parallel to the grain orientation. This results in a lower reluctance, although the manufacturing costs are higher.

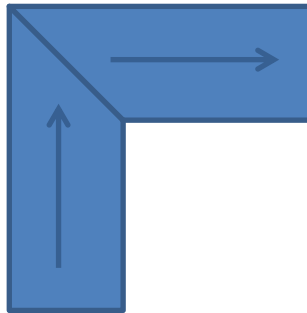

Figure 23: Mitred joints. The arrows represent the grain orientation of the steel.

Mitred joints were selected as being most suitable because their lower reluctance will reduce the amount of current required to achieve 1.8 T. They were used in all the modelling.

4.1.2. Manufacture

The laminations themselves could be stamped, water cut or laser cut to size. Regardless of what manufacturing process is used, the continuously varying cross-section of some of the magnets will make them challenging to construct from laminations. Possible options are:

- cutting each lamination to a different shape such that when they are brought together they form a smooth variation in cross-section. The advantage here is the reduction in wasted material.
- cutting all the laminations to a constant shape and then post-machining the desired shape. This is likely to be easier, and therefore have lower manufacturing costs, than trying to assemble laminations in a given order along the 50 m beamline.
- allowing step-changes in cross-sectional area at regular intervals (e.g. 1 m). This would avoid wasting material and the difficulty of assembling the laminations in the correct order; however, the field would be further from the initial requirements.

Active Muon Shield
Preliminary Magnet Design Report

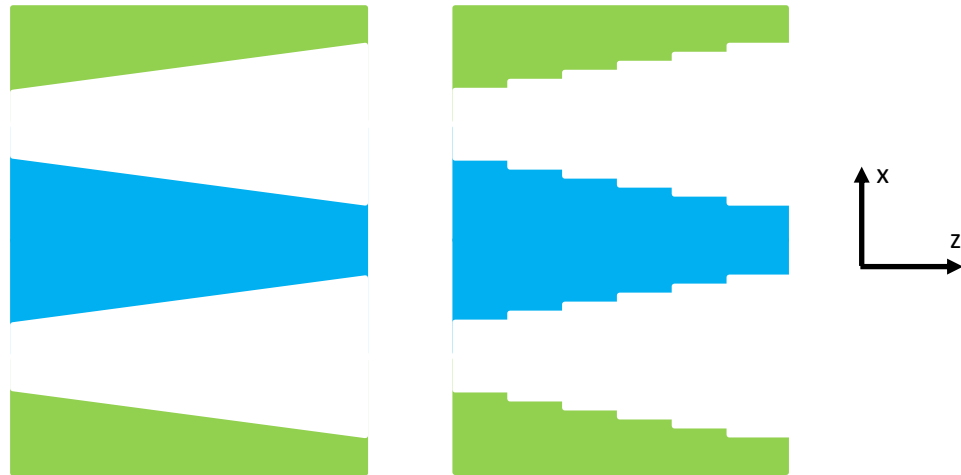

Figure 24: Example of stepped fields in magnet B0 to simplify the manufacturing process (desired field at $y=0$, the blue and green regions indicate the positive and negative 1.8 T B_y fields respectively).

The modelling that has been done so far has assumed that all the laminations are normal to the z axis and that the front and back faces of the magnets are also normal to the z-axis. This does not have to be the case and it may be easier to manufacture some of the magnets if the laminations are normal to the length of the magnet and the magnet is rotated as shown in Figure 25.

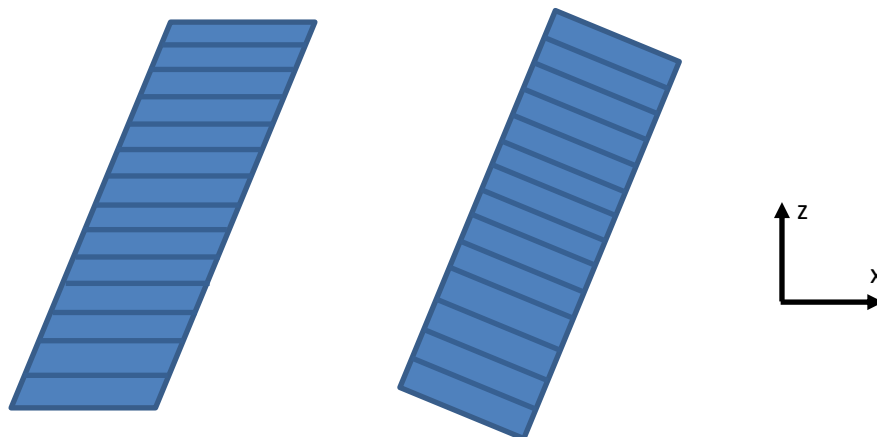

Figure 25: A diagram showing the different ways of aligning the laminations. The diagram on the left is the orientation that has been modelled.

There are a number of ways in which the laminations could be held together.

- *Glued*⁴

This method is commonly used for small accelerator magnets. The laminations are coated in a resin and compressed using a metal frame. The assembly is cured in an oven and the frame is removed. This method is probably not suitable for the SHIP magnets as the frame would have to be very large and the resin would probably not be strong enough to support the steel.

⁴ Iron Dominated Electromagnets Design, Fabrication, Assembly and Measurements, J. Tanabe, p. 266

Active Muon Shield
Preliminary Magnet Design Report

- *Welded*⁵
This is another method used in the manufacture of accelerator magnets. The laminations are compressed in a frame, metal bars are placed lengthways along the magnet and the laminations are welded to the bars. The frame is then removed. This method is not suitable for long accelerator magnets because the welding causes the metal to warp. However, this may not be a problem for the SHiP magnets as the geometrical tolerances are not tight.
- *Bolted*⁶
This method is used for creating accelerator magnets with tight tolerances. A metal frame is constructed around the compressed laminations and this frame is bolted and doweled together. This method is expensive and is difficult to use with long magnets so is not recommended for the SHiP magnets.
- *Epoxy impregnated glass tape*⁷
This method is commonly used in the assembly of transformer coils. The laminations are clamped together by steel bands and an epoxy impregnated tape is wrapped around the core. The tape is then cured in an oven and shrinks, compressing the laminations. The steel bands are then removed. This method may not be practical because the magnets for SHiP are much longer than transformer cores. However, this method may be possible if the cores were assembled in sections.

4.2. US1010 yoke

A yoke made from soft iron, such as US1010, could be easier to manufacture as the yoke could be made from simple blocks. It is worth noting that some manufacturing processes degrade the magnetic performance of the steel. This affect could then be reversed by annealing the steel once cut to size.

4.3.Coils

The design of the coils is very important as they have a large impact on the reliability and the running costs of the magnets.

4.3.1. Cooling

The losses in the coils are dissipated as heat. To prevent the coils from overheating and the wire insulation being damaged, different cooling techniques can be employed:

- *Air cooling*
Air cooling is the lowest cost cooling method and is suitable for low power magnets. The air can be allowed to undergo natural convection or can be fan assisted. Heat exchangers can be used to improve conduction from the coil to the air. Air cooling is suitable for coils with a current density less than 1 A/mm^2 .⁸
If air cooling is used, the heat lift of the experimental hall's air condition system will have to be considered. If the magnets are producing more heat than the air conditioning can cope with, a different magnet cooling method may be required.

⁵ Iron Dominated Electromagnets Design, Fabrication, Assembly and Measurements, J. Tanabe, p. 271

⁶ Iron Dominated Electromagnets Design, Fabrication, Assembly and Measurements, J. Tanabe, p. 273

⁷ Transformers, BHEL, Tata McGraw-Hill, p. 105

⁸ CERN Accelerator School – Magnets (2009), Th. Zickler, p. 92

Active Muon Shield Preliminary Magnet Design Report

- *Water cooling*
Accelerator magnets are commonly water cooled. Hollow conductors are used in the coils and water is pumped through the centre. This water is then cooled by an external cooling circuit. Water cooling enables much higher current densities to be used than air cooling (10 A/mm²) although it costs more to install and operate. The added complexity also reduces the reliability of the magnet.
- *Oil cooling*
Oil cooling is commonly used for large transformers. The coil and yoke are submerged in oil which is either pumped or circulates by convection. This method has the advantage of cooling both the coil and the iron which is necessary in transformers due to the core losses. It also acts as an insulator, preventing electrical breakdown.

Air cooled coils appear to be the most suitable for the SHiP magnets. If grain-orientated steel is used, the currents required are very low and there is a lot of room for the coils, even when using current densities of 0.5 A/mm². A quick cost trade-off shows that the increased material costs of building larger magnets for low current densities is offset by the reduced cooling costs. If US1010 is used, air cooling can also be used for all the coils except those of magnet C0. Magnet C0 requires such a large number of amp-turns that water cooling is required. Oil cooling of the iron is not necessary for the SHiP magnets because the coils are DC so there are no core losses present.

4.3.2. Material

A trade-off between copper and aluminium wire will need to be carried out. Copper has a lower resistivity than aluminium and requires 60% of the cross-sectional area of aluminium for the same resistance. However, aluminium wire is less expensive so may be more cost effective overall.

The diameter of the wire is mainly determined by the power supply. Many turns of a fine wire and fewer turns of a coarse wire will have the same total resistance if they take up the same volume (not accounting for the packing factor). However, manufacturing costs also needs to be considered; it will take longer to wind many turns of a fine wire and, if the wire is too thick, it will be difficult to bend around the former. Thinner wires are usually insulated with a baked on plastic coating. Thicker wires are often insulated by wrapping them with tape.

4.3.3. Manufacture

Once the coils have been wound, they will need to be potted so that the wires do not move within the coil and they are protected from dirt and moisture. In the case of SHiP, where the field quality is not too important, preventing movement within the coil is less critical than some magnets, but movement should be avoided as it could still ultimately lead to mechanical problems such as wearing of conductor insulation or fatigue. There are a number of different techniques for coil potting.

- Wet layup is a simple way of potting a coil. Epoxy is painted on the wire as it is wound and the assembled coil is then cured in an oven.
- Vacuum impregnation is often used on coils for accelerator magnets and is very effective at protecting the coil from its environment and preventing movement of the wire within the coil. Vacuum impregnated coils are therefore preferable but the process is expensive, especially for larger magnets.

Active Muon Shield
Preliminary Magnet Design Report

Since the coil for magnet B0 is 12 m long, it would be very expensive to manufacture. A simple way of bringing down the manufacturing cost would be to split B0 into two magnets along the z-axis, so that there are two 6 m long magnets rather than a 12 m long magnet. Assuming the coils are vacuum impregnated with resin, there will be many more manufacturers able to vacuum impregnate a 6 m than a 12 m coil.

4.3.4. Power Supply

The power supply selection is determined by what wire is used for each coil. For larger wire with fewer turns, a higher current is required. A typical current limit for a power supply is a few hundred amps and it is difficult to find power supplies that can provide over 1000 A. This should be taken into account when selecting the wire.

It may be possible to connect all the magnets in series and run them with a single power supply. However, the number of turns in each coil would have to be carefully selected beforehand to ensure that the magnetic field had the required properties for every magnet. Using individual power supplies would provide more control.

5. Costs

These cost estimates are a result of conversations with magnet designers within STFC and at CERN. In both options the total capital costs are dominated by the material costs of steel and copper. It should be noted that the steel costs have varied by a factor of four in the last ten years (increased and then decreased again), so there is potential for this to happen again within the timescale of this project. The current design for the muon filter uses 2900 tonnes of steel in the yoke.

Other costs that will need consideration but not included here include transport and infrastructure around the magnets (including cooling systems and power supplies).

Details of the coil costs – both material requirements and powering – are contained in Appendix A.

Costs	Option 1: GO steel	Option 2: US1010
<i>Capital Costs</i>		
Steel material (MCHF)	8.7	8.7
Steel manufacturing (MCHF)	0.5	
Coil (MCHF)	1.5	5
<i>Operating costs</i>		
Power (kW)	6	300

Table 5: Cost estimates.

6. Future Work

Areas which require further work:

- Optimisation of what steel should be used where
- Consideration of using stepped laminations, as described in paragraph 4.1.2
- Method of yoke manufacture
- Support structure for the coils
- Will the field in the iron be measured and how?

Active Muon Shield
Preliminary Magnet Design Report

Appendix A: Forces on the coils

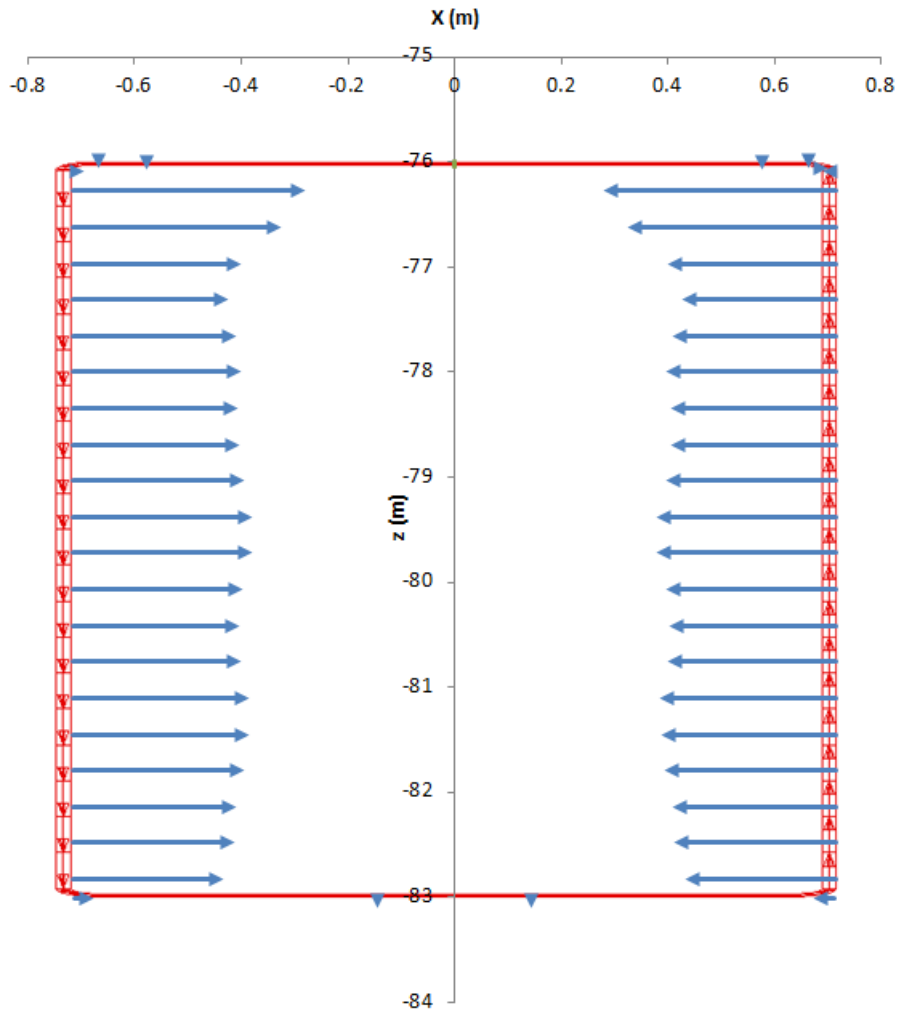

Figure 26: A0 with GO steel – maximum force 0.7 N.

Active Muon Shield
Preliminary Magnet Design Report

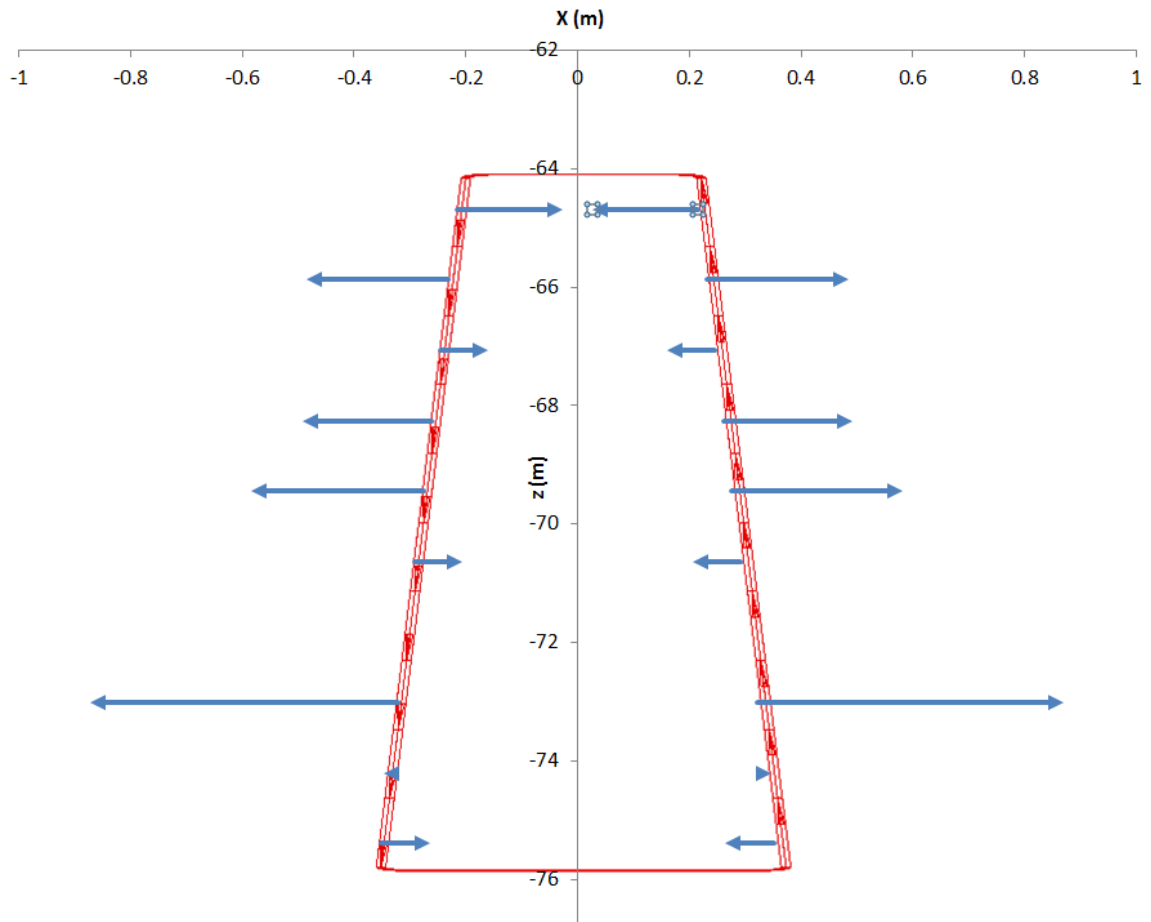

Figure 27: B0 with GO steel – maximum force 1.1 N.

Active Muon Shield
Preliminary Magnet Design Report

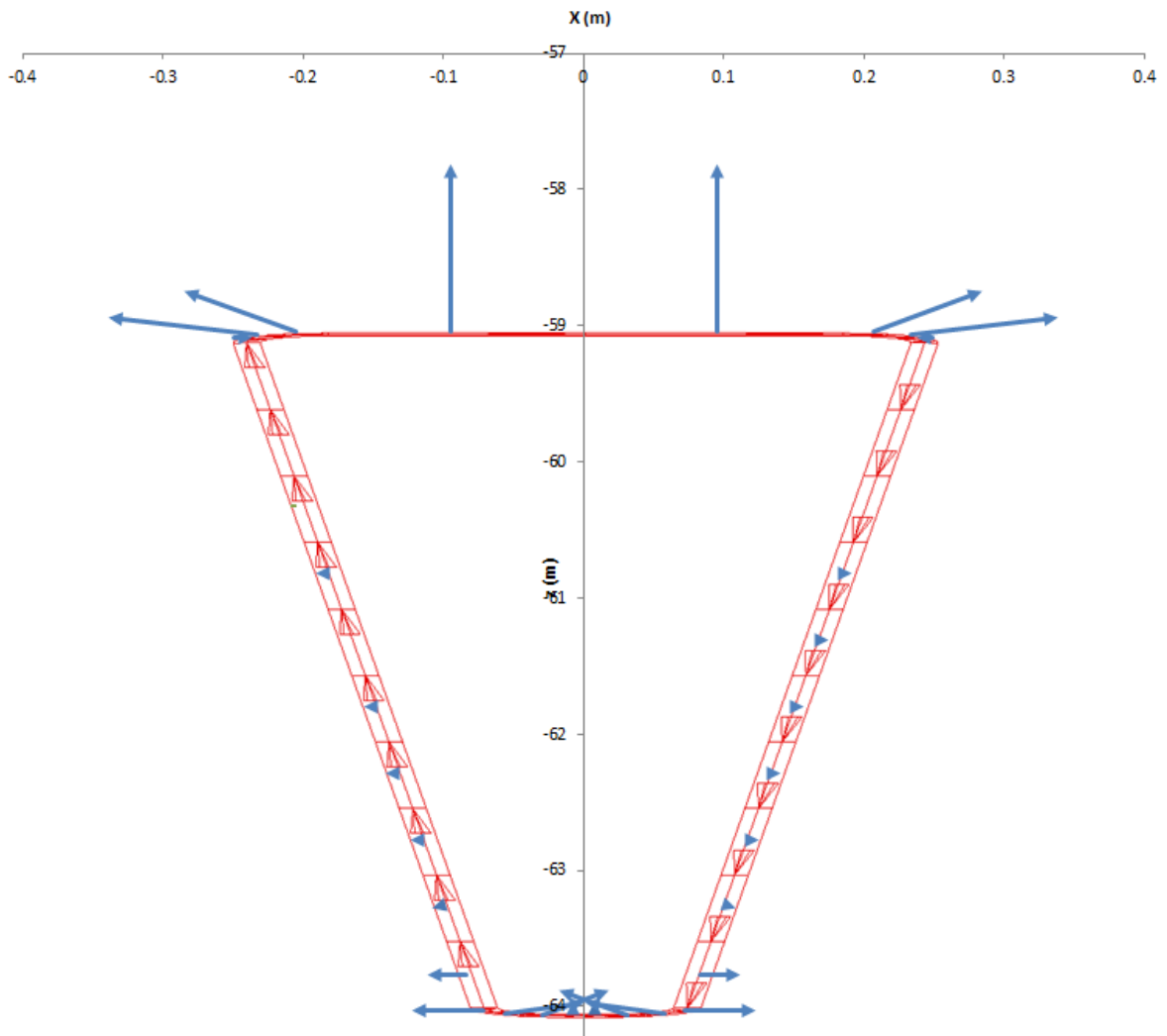

Figure 28: C0 with GO steel – maximum force 0.3 N.

Active Muon Shield
Preliminary Magnet Design Report

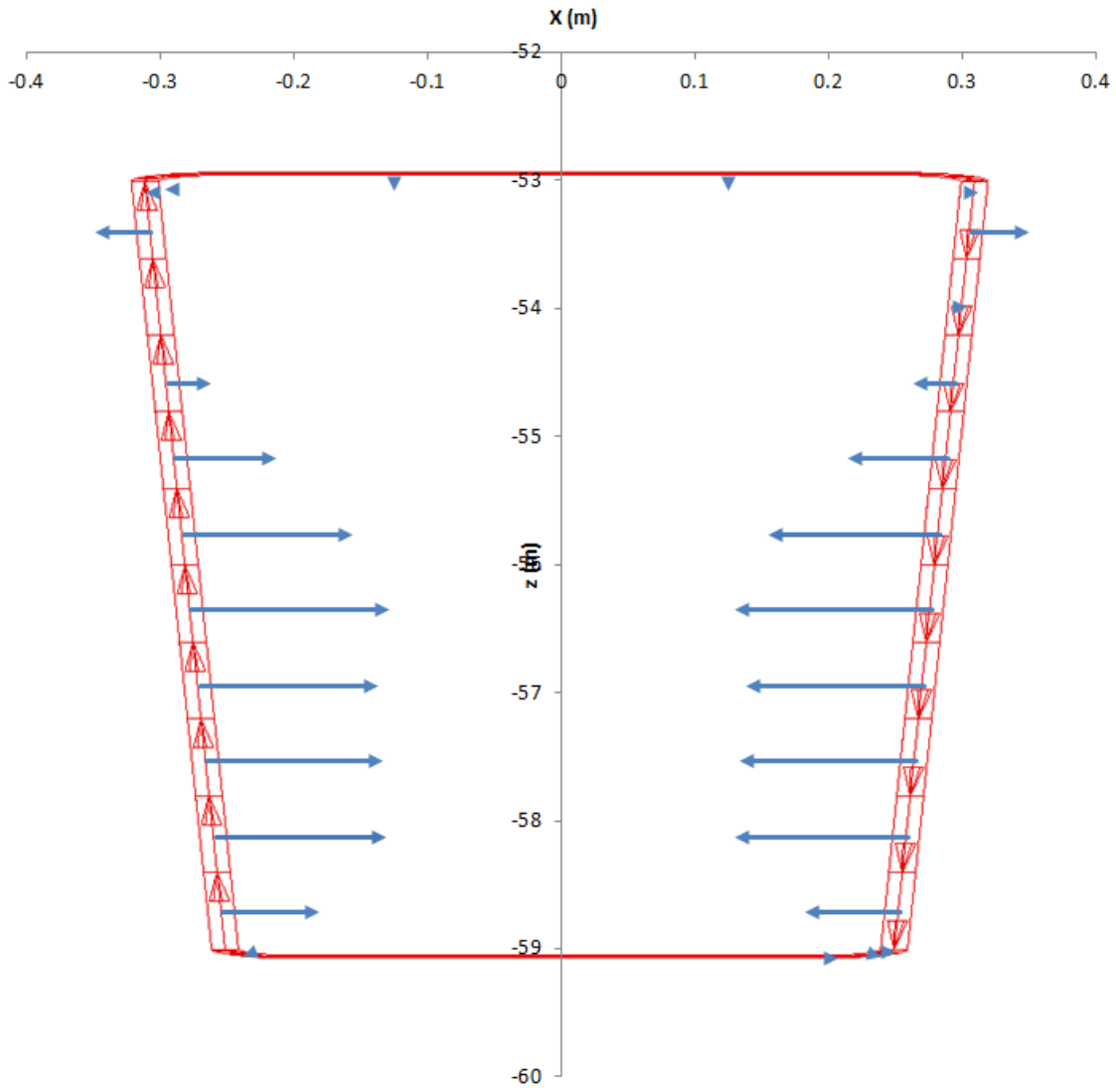

Figure 29: C4 with GO steel – maximum force 2.7 N.



CERN-SHIP-PUB-2015-003
26 June 2015

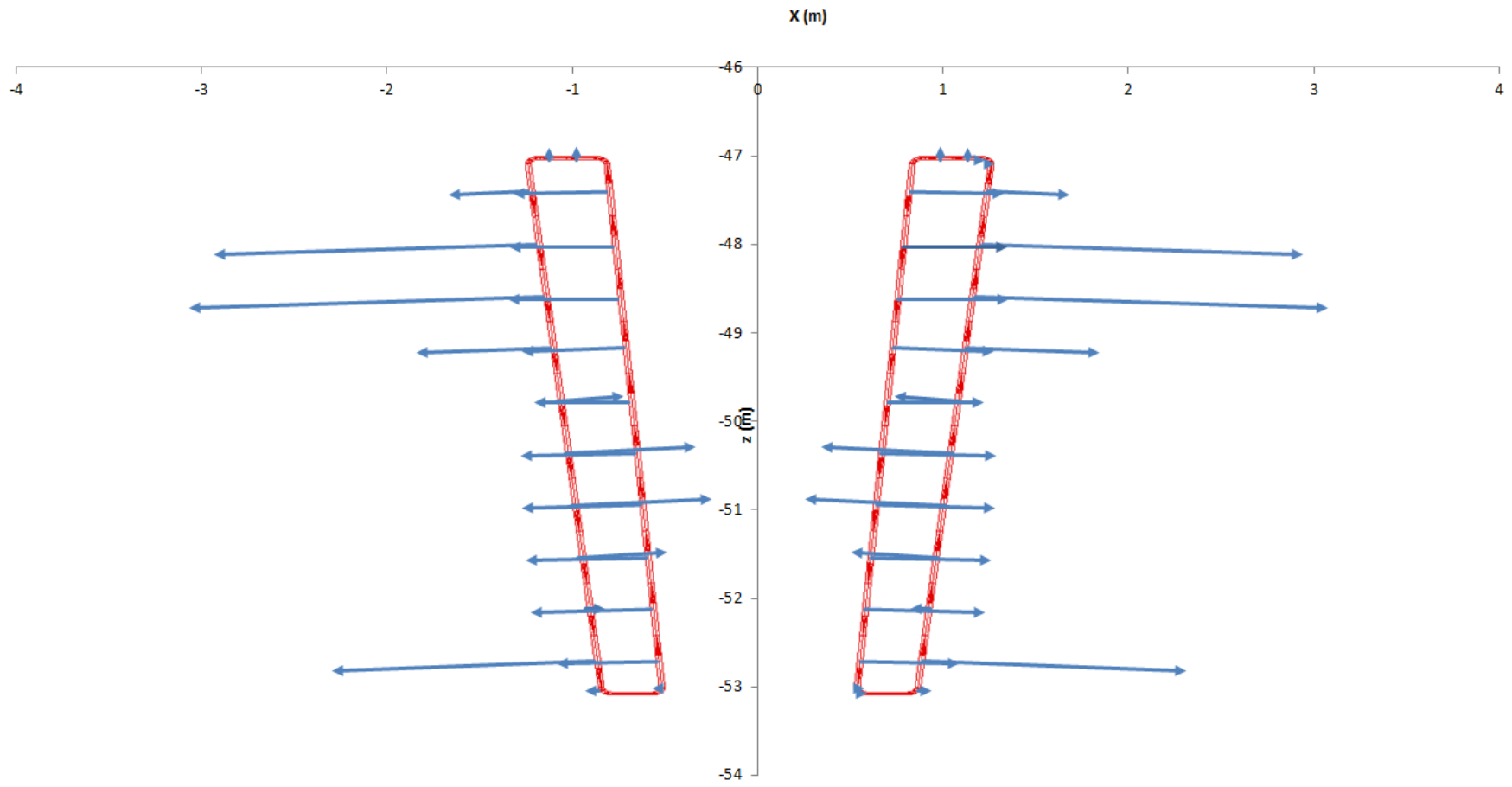

Figure 30: C6 with GO steel – maximum force 2.3 N.

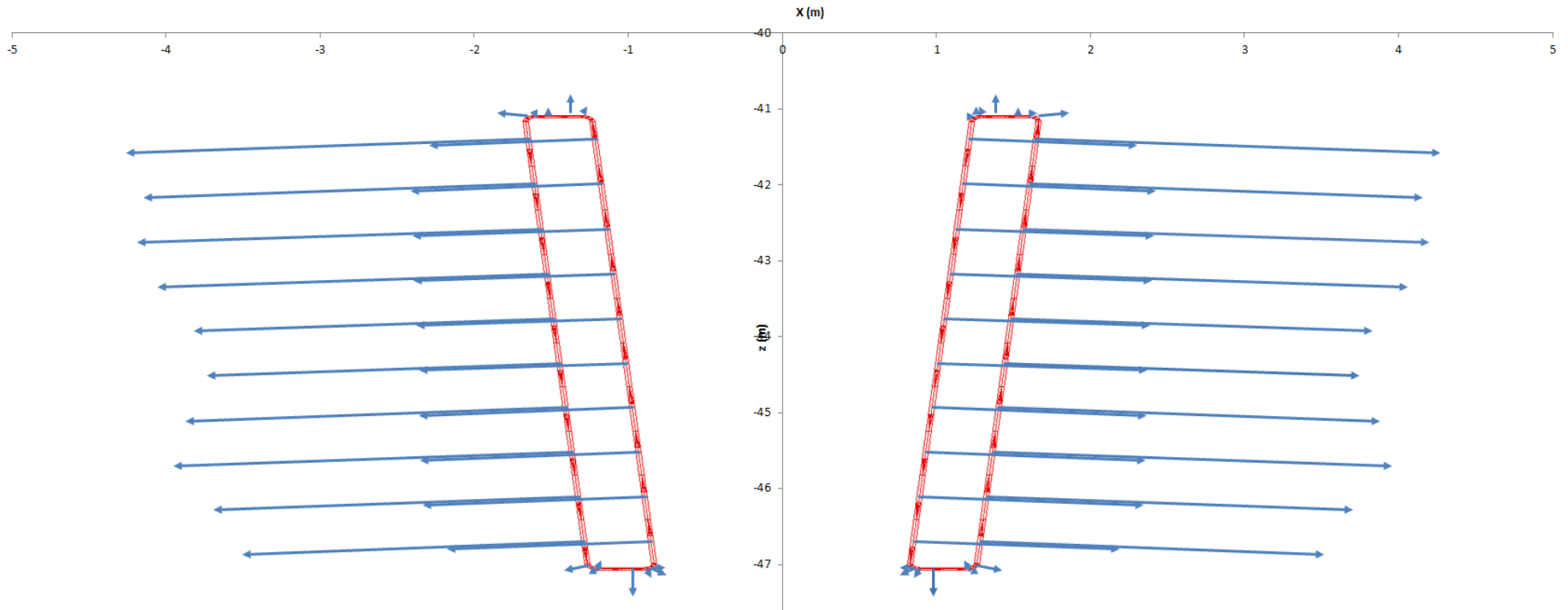

Figure 31: C7 with GO steel - maximum force 2.6 N.

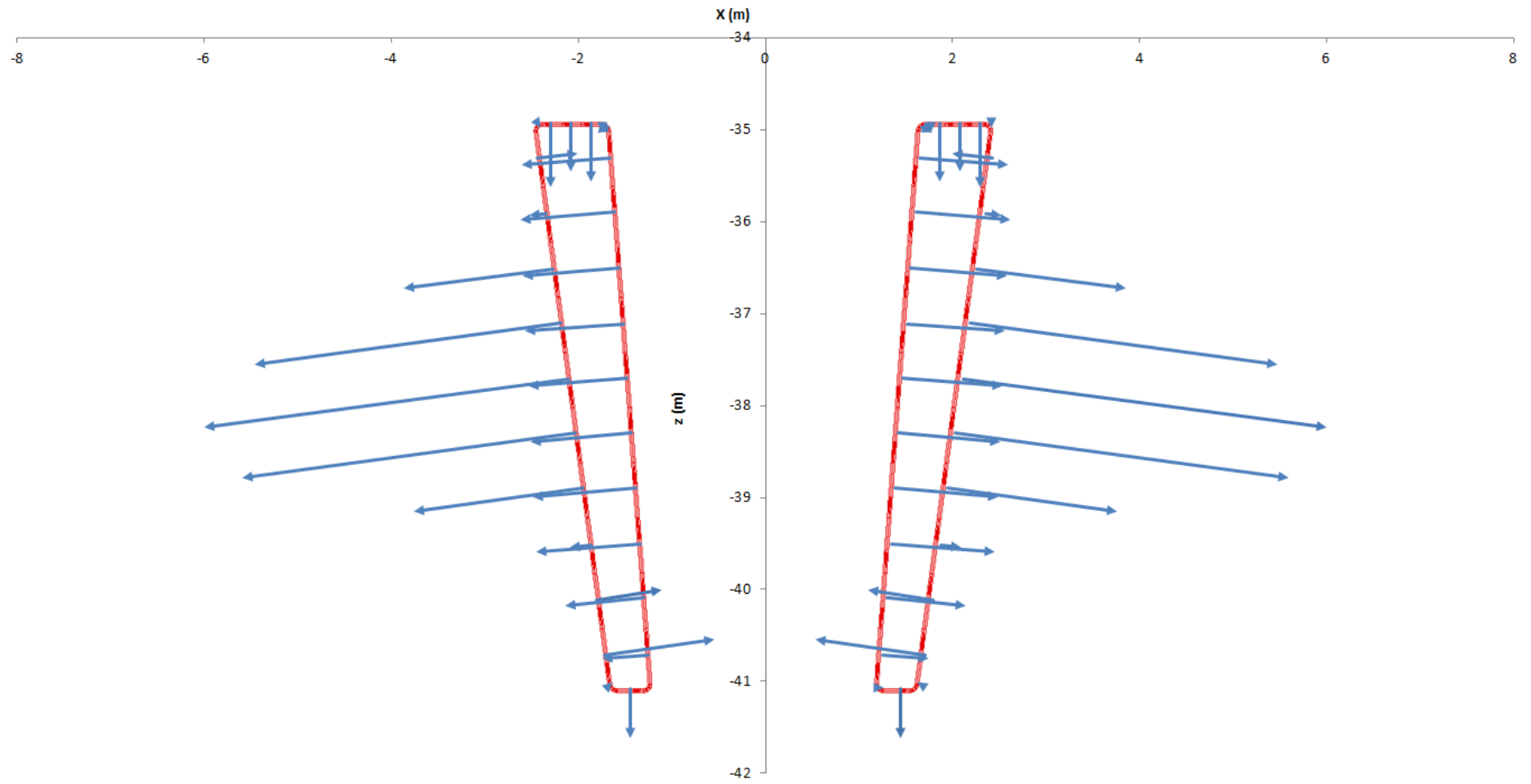

Figure 32: C8 with GO steel– maximum force 5.7 N.



Appendix B: Coil cost estimates

The estimates below are based on these inputs⁹:

Current density = 5×10^5 A/m²

Conductor fill factor = 0.63

Copper density = 8940 kg/m³

Copper resistivity 1.72×10^{-8} Ωm

Copper price = 16 CHF/kg

Option 1: Grain- orientated steel

Magnet Name	Coil Position	Number of Coils	Total Amp Turns (kA)	Amp Turns per Coil (A)	Coil Length (m)	Coil Width (m)	Cross-Sectional Area per Coil (m ²)	Cross Section Width (m)	Cross Section Height (m)	Mean Turn Length of Each Coil (m)	Parallel Resistance per Coil (μΩ)	Power Requirement per Coil (kW)	Total Power Requirements (kW)	Copper Mass per Coil (kg)	Total Mass (kg)	Wire Cost per Coil (kCHF)	Total Wire Cost (kCHF)
A0	Top and bottom	2	3.2	1.6	7	1.4	3.20E-03	0.06	0.06	16.4	140	0.36	0.72	296	592	4.7	9.5
B0	Top and bottom	2	1.8	0.9	12	0.7	1.80E-03	0.04	0.04	24.7	375	0.30	0.61	251	501	4.0	8.0
C0	Middle	1	1.2	1.2	5	0.5	2.40E-03	0.02	0.12	10.2	116	0.17	0.17	138	138	2.2	2.2
C4	Middle	1	3	3	6	0.6	6.00E-03	0.02	0.30	12.7	58	0.52	0.52	427	427	6.8	6.8

⁹ CAS Magnets pg 93 and private communications

Active Muon Shield

Preliminary Magnet Design Report

C6	Middle	1	4.5	4.5	6	1.3	9.00E-03	0.09	0.09	13.7	42	0.84	0.84	696	696	11.1	11.1
C7	Middle	1	5.5	5.5	6	2.1	1.10E-02	0.10	0.10	15.2	38	1.14	1.14	940	940	15.0	15.0
C8	Middle	1	8	8	6	3	1.60E-02	0.13	0.13	17.4	30	1.90	1.90	1572	1572	25.1	25.1
Total		9	27.2	24.7	48	10	0.05	0.47	0.85	110	798	5.23	5.90	4319	4866	69.1	77.9

Option 2: US1010

Magnet Name	Coil Position	Number of Coils	Total Amp Turns (A)	Amp Turns per Coil (A)	Coil Length (m)	Coil Width (m)	Cross-Sectional Area per Coil (m ²)	Cross Section Width (m)	Cross Section Height (m)	Mean Turn Length of Each Coil (m)	Parallel Resistance per Coil ($\mu\Omega$)	Power Requirement per Coil (kW)	Total Power Requirements (kW)	Copper Mass per Coil (kg)	Total Mass (kg)	Wire Cost per Coil (kCHF)	Total Wire Cost (kCHF)
A0	Top and bottom	2	56	28	7	1.4	5.6E-02	0.20	0.28	16.43	8.0	6	13	5182	10364	83	166
B0	Top and bottom	2	29	14.5	12	0.7	2.9E-02	0.17	0.17	24.71	23.3	5	10	4036	8072	65	129
C0	Middle	4	400	100	5	0.5	2.0E-01	0.45	0.45	24.71	3.4	34	135	27834	111337	445	1781
C4	Middle	4	340	85	6	0.6	1.7E-01	0.41	0.41	24.71	4.0	29	115	23659	94637	379	1514
C6	Middle	1	50	50	6	1.3	1.0E-01	0.20	0.50	13.73	3.7	9	9	7733	7733	124	124
C7	Middle	1	55	55	6	2.1	1.1E-01	0.20	0.55	15.17	3.8	11	11	9398	9398	150	150
C8	Middle	1	65	65	6	3	1.3E-01	0.20	0.65	17.44	3.7	15	15	12769	12769	204	204
Total		15	995	397.5	48	10	0.80	1.83	3.01	137	49.8	110	308	90612	254311	1450	4069