

/lmg

CERN/PS 89-27 (RF)  
March, 1989

KICKERS USED FOR BUNCHED  $E^+$ / $E^-$  BEAM TRANSFER IN THE CERN PS COMPLEX

T. Fowler  
J.-C. Freze  
D. Grier  
K.D. Metzmacher  
L. Sermeus

Paper presented at the  
1989 PAC Particle Accelerator Conference  
Chicago 20-23rd March, 1989

# KICKERS USED FOR BUNCHED $e^+ / e^-$ BEAM TRANSFER IN THE CERN PS COMPLEX

T. Fowler, J.-C. Freze, D. Grier, K.D. Metzmacher, L. Sermeus.  
CERN, 1211 Geneva 23, Switzerland

**Abstract :** The main characteristics and operating experience of the 100 Hz pulsed injection kicker and the eight pulse burst ejection kicker systems installed in the EPA ring are described. Delay line type magnets placed in vacuum tanks are excited by fast pulses generated from thyatron switched PFN's. Deflecting fields of 52 ns FWHH with rise and fall times of 28 ns are achieved.

Up to eight  $e^+$  or  $e^-$  bunches are injected into the PS in a single turn. For each particle type, one delay line type magnet is used. Both magnets are excited from the same PFN, switched at either end, with a pulse of 2000 A and 2  $\mu$ s duration.

## Introduction

CERN is currently engaged in the Large Electron Positron (LEP) project.

Electrons and positrons, accelerated in purpose-built linacs, are accumulated in a new Electron Positron Accumulator ring (EPA), before being transferred to the LEP main ring via the existing Proton Synchrotron (PS) and the Super Proton Synchrotron (SPS).

The EPA ring (Fig. 1) which became operational in May 1986, acts as a buffer between the fast cycling (100 Hz) but low intensity linacs and the slow cycling (0.8 Hz), high intensity PS.

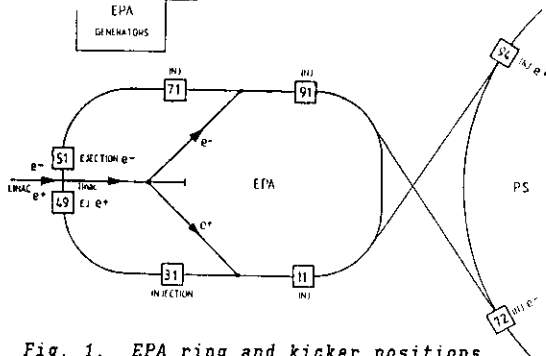

Fig. 1. EPA ring and kicker positions.

Bunches of 12 ns (FWHH) duration are injected into EPA by four fast delay line magnets grouped in two pairs to create an orbit bump. Each pair is housed in a vacuum tank and pulsed from a common pulser. The circulating beam is perturbed only within the bump, being brought close to but not hitting the septum. The newly injected beam, after passing through the septum magnet is placed on orbit by a second pair of kickers.

From EPA, the eight bunches of  $e^+$  or  $e^-$ , accumulated at 100 Hz during periods of between 0.6 and 12 s are ejected in succession towards the PS ring. The bunches circulating in EPA have a length of 1 ns and pass the ejection point every 52.4 ns. For synchronisation with the transfer process, every fifth bunch must be extracted, giving a bunch to bunch spacing of -262 ns in the transfer line. The extraction is performed by two delay line magnets (for each particle type) placed in the same vacuum tank and pulsed alternately from a dual four pulse burst generator. These eight bunches are then injected into the PS by one delay line magnet delivering a long 1.85  $\mu$ s flat-top pulse and fed by a 80 kV cable PFN pulse generator. Both  $e^+$  and  $e^-$  particles have their dedicated kicker magnet but the generator is common.

## EPA Injection

### 1. Magnets

Four delay line magnets (for each particle type) are placed in two vacuum tanks.

Their design follows the technique well established at CERN [1]. The magnet modules (Fig. 2) are

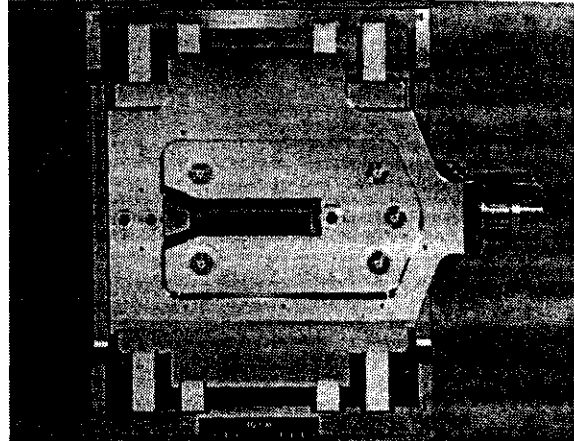

Fig. 2. 7 cell EPA injection kicker magnet module.

L.C. ladder networks of 7 cells with a characteristic impedance of  $\sim 30 \Omega$ . Each cell comprises a three block ferrite C-core, loosely sandwiched by AlMg3 alloy plates which are high voltage (HV) pulsed and interleaved with similar plates held at earth (E) potential. Cell inductance is provided by the ferrite bounded aperture and cell capacitance is that between HV and E plates. The design characteristic impedance is obtained by correctly dimensioning the capacitor plate system.

The module is a single turn device; its HV stainless steel conductor is located inside the C-core aperture and is connected to all HV capacitor plates via Inconel spacers and stainless steel rods. This material choice permits bake-outs of the assembly to 300°C in order to obtain low degassing rates.

The earth conductor, which is similarly joined to all earth plates closes the aperture. The deflecting field is the combination of the magnetic and electric fields, the former being predominant. Both extremities of the module conductors are connected by matched strip lines to coaxial feed-throughs in the tank wall.

The magnets are terminated by 30  $\Omega$  oil immersed carbon disc resistors.

Magnet parameters are given in Table 1 below :

Horizontal aperture	(mm)	110
Vertical aperture	(mm)	35
Uniform field aperture $\pm 1\%$	(mm x mm)	60 x 32
Length	(mm)	207
Max. kick strength $\approx 35$ kV	(T.m)	.0036
Impedance	( $\Omega$ )	-30
Wave travelling time	(ns)	-24
Kick rise fall (10 - 90)%	(ns)	27

## 2. Pulse generator

Both magnets of each injection tank are pulsed simultaneously from one half of a dual pulse generator, as shown in Fig. 3.

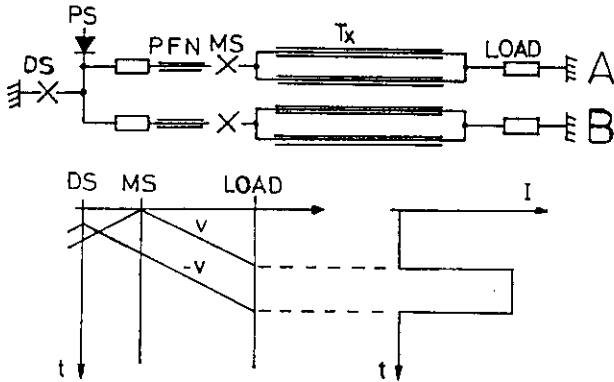

Fig. 3. EPA injection generator schematic with pulse derivation.

The principle is as follows :

A Pulse Forming Network (made of two 30  $\Omega$  cables) is charged to a voltage 2V. The charging (ref. 2 and Fig. 4) is initiated by the trigger to the thyristor TH1, which partly discharges  $C_0$  into the PFN's via a 300 to 1 step up transformer TR1. HT diode chain D1 maintains the HT flat top on the PFN while the trans-

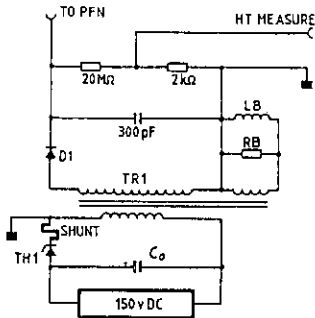

Fig. 4. Schematic of PFN resonant charging circuit.

former secondary voltage oscillates during core recovery. Components  $R_B$  and  $L_B$  have been added to the conventional circuit in order to enable the transformer core to recover within 6 ms. Fig. 5 shows the TR1 primary current and the corresponding PFN voltage waveform at a frequency of 100 Hz.

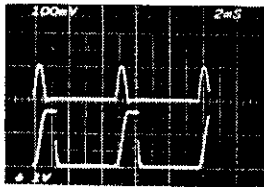

Fig. 5. PFN charging waveforms  
Upper : Primary Current  
Lower : PFN voltage.

The single gap hydrogen thyratron main switches (EEV type CX 1154 A/2) are then triggered simultaneously. The pulse rise time achieved is between 15 and 20 ns (10 - 90)%. A common dump switch (CX 1154 A/2) is then fired to achieve a pulse length of 52.4 ns FWHH and a fall time of 20 ns (90 - 10)%. The nominal PFN voltage is 22 kV for a 600 MeV injected beam.

## 3. Performance

A typical  $[Bd]$  of one tank is given in Fig. 6. The position of three bunches is also indicated on this photo. The maximum relative kick distortion on each bunch is below 5%, the parasitic kick given to circulating bunches being below 4%.

The system has been operated successfully up to maximum voltage since June 1986, and has completed  $2 \times 10^9$  pulses with good reliability and no noticeable thyratron deterioration.

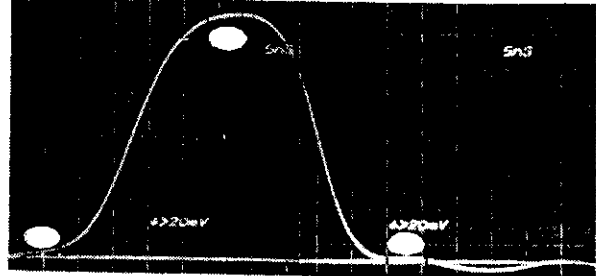

Fig. 6. Sum kick of two magnets in same tank.

### EPA Ejection

#### 1. Magnets

For economic reasons it was decided to use the same magnets as for injection with a minor change in the gap width which has been reduced by 10 mm because of the smaller uniform field region required (beam diameter less than 1 mm). The thickness of the HT conductor has been increased by 10 mm, all the other parameters being unchanged.

The eight equidistant (262 ns) kicks of 52.4 ns duration are provided by alternately pulsing two magnets from a pulse burst generator. The  $[Bd]$  of 36 G.m required to eject a 600 MeV beam is achieved with a PFN voltage of 35 kV.

#### 2. Pulse burst generator

The generator (Ref. 3 and Fig. 7) consists of 2 cascades of 4 thyratrons in series (EEV type CX 1154). In order to avoid auto triggering of the series thyratrons with consequent loss of timing control, the tubes are connected with the anodes towards the load and are of screen grid type. The two PFN's are charged from a common power supply to a negative potential.

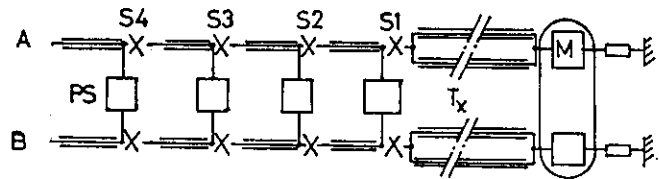

Fig. 7. Schematic of eight pulse burst generator.

The switches are connected in series via 30  $\Omega$  pulse forming (PFN) cables of 52.4 ns pulse length. With tube screen grids short-circuited to the cathodes, auto-triggering due to the PFN wave fronts is eliminated and pulse to pulse intervals of up to 20  $\mu$ s are possible. Above 20  $\mu$ s tube de-ionisation causes distortion of the output pulses. Pulse degradation due to the stray capacity of the cathode/heater supply circuits is minimised by use of low inductance connections and using the resulting capacitive elements as part of the compensation of tube inductance.

### 3. Performance

A typical eight pulse current burst with triggering sequence S1A, S1B, S2A ... S4B is shown in Fig. 8. The charging voltage of each PFN pair has been adjusted to obtain equal amplitudes of the four pulses at each side.

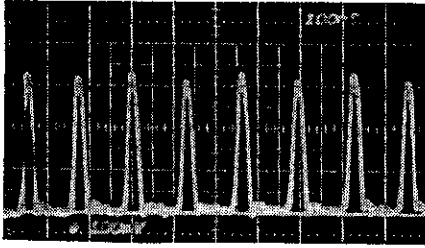

Fig. 8. Eight pulse burst current after magnet traversal.

The four pulse kick in one magnet is shown in Fig. 9. Transmission loss from pulse to pulse (with equally charged PFN's) is clearly visible. This can be corrected by differentially charging the PFN's.

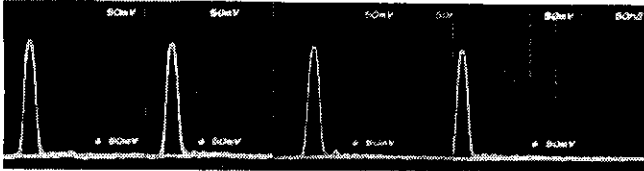

Fig. 9. Four kicks of one magnet.

The ejection kickers have completed two years of operation at various voltages and with different numbers of bunches and permit reliable fast ejections with good efficiency.

#### PS injection

##### 1. Magnets

Injection of  $e^+$  and  $e^-$  bunches into the PS is made in one turn by one delay line magnet [see Fig. 10] for each particle type. Each magnet is built of 24 cells with a characteristic impedance of 15  $\Omega$ . The aperture area is dictated by the PS p-p beams and is larger than that needed for  $e^+/e^-$  operation.

In order to keep the magnet pulse voltage around 30 kV, the full straight section length has been used to obtain the 198 G.m kick required.

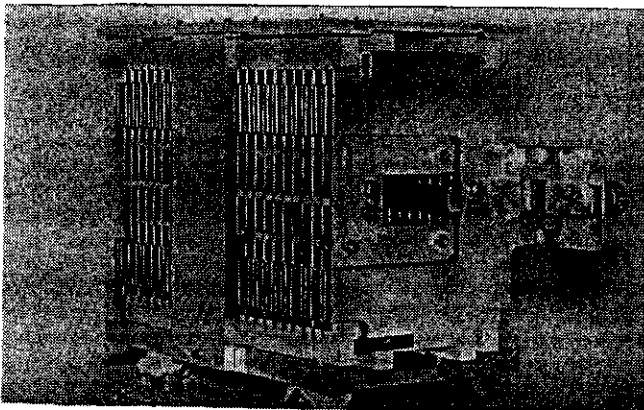

Fig. 10. 24 cell PS injection kicker magnet module.

Table 2 below summarizes the main magnet characteristics.

Horizontal aperture	(mm)	: 112
Vertical aperture	(mm)	: 74
Uniform field aperture $\pm 1\%$	(mm x mm)	: 60 x 25
Length	(mm)	: 615
Maximum kick strength @ 80 kV	(T.m)	: .026
Impedance	( $\Omega$ )	: - 15
Wave travelling time	(ns)	: 76
Kick rise-fall (10-90)%	(ns)	: 76

##### 2. Pulse generator

The eight 1 ns long bunches ejected from EPA have to be injected equally spaced into the PS in one turn. Therefore kick flat top of minimum 1.85  $\mu$ s is needed with a maximum fall time (100-0)% allowance of 250 ns. The possibility of using an existing SF<sub>6</sub> filled 80 kV cable PFN has been exploited. Since the two magnets are not needed simultaneously the single PFN suffices with the magnets connected as shown in Fig. 11, permitting each to be excited as determined by the thyatron trigger timing sequence.

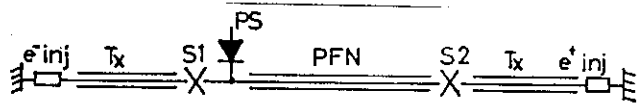

Fig. 11. Schematic of special  $e^+/e^-$  PS injection generator.

Circuit symmetry and properly sequenced timing allow pulse excitation of either magnet. For safety reasons (in case of a magnet flash-over occurring) both thyratrons (EEV CX1171) are triggered; a short duration (100 ns) current pulse is dumped into the "unused" magnet. Chosen transmission lengths and particle flight times permit this without disturbing the already injected beam. The nominal operating voltage is 60 kV PFN corresponding to a magnet current of 1960 A.

##### 3. Performance

The PS  $e^+/e^-$  injection system described has operated successfully during the last two years. A transfer efficiency between EPA and PS exceeding 90% has been achieved.

##### Acknowledgements

Useful discussions with the English Electric Valve Company, Chelmsford, UK and the support of the CERN-PS kicker section are gratefully acknowledged.

##### References

- [1] Hardware for a full aperture kicker system for the GPS. D.C. Fiander, Proc. of PAC, Chicago, 1971, p.1022.
- [2] A resonant pulsed power supply for kicker magnet pulse forming networks, D. Fiander, P. Pearce, CERN/MPS/SR 69-11.
- [3] A fast rise time high voltage pulse burst generator, D. Grier and K.D. Metzmacher, Proc. of 4th IEEE PPC, Albuquerque, 1983, p.251.
- [4] Status report of the LEP preinjector (LPI) and the PS as  $e^+e^-$  accelerator. S. Battisti et al, Proc. of EPAC, Rome, June 1988, to be published.