



CERN-PH-EP-2014-179

Submitted to: PLB

Search for $H \rightarrow \gamma\gamma$ produced in association with top quarks and constraints on the Yukawa coupling between the top quark and the Higgs boson using data taken at 7 TeV and 8 TeV with the ATLAS detector

The ATLAS Collaboration

Abstract

A search is performed for Higgs bosons produced in association with top quarks using the diphoton decay mode of the Higgs boson. Selection requirements are optimized separately for leptonic and fully hadronic final states from the top quark decays. The dataset used corresponds to an integrated luminosity of 4.5 fb^{-1} of proton–proton collisions at a center-of-mass energy of 7 TeV and 20.3 fb^{-1} at 8 TeV recorded by the ATLAS detector at the CERN Large Hadron Collider. No significant excess over the background prediction is observed and upper limits are set on the $t\bar{t}H$ production cross section. The observed exclusion upper limit at 95% confidence level is 6.7 times the predicted Standard Model cross section value. In addition, limits are set on the strength of the Yukawa coupling between the top quark and the Higgs boson, taking into account the dependence of the $t\bar{t}H$ and tH cross sections as well as the $H \rightarrow \gamma\gamma$ branching fraction on the Yukawa coupling. Lower and upper limits at 95% confidence level are set at -1.3 and $+8.0$ times the Yukawa coupling strength in the Standard Model.

arXiv:1409.3122v2 [hep-ex] 22 Dec 2014

Search for $H \rightarrow \gamma\gamma$ produced in association with top quarks and constraints on the Yukawa coupling between the top quark and the Higgs boson using data taken at 7 TeV and 8 TeV with the ATLAS detector

The ATLAS Collaboration

Abstract

A search is performed for Higgs bosons produced in association with top quarks using the diphoton decay mode of the Higgs boson. Selection requirements are optimized separately for leptonic and fully hadronic final states from the top quark decays. The dataset used corresponds to an integrated luminosity of 4.5 fb^{-1} of proton–proton collisions at a center-of-mass energy of 7 TeV and 20.3 fb^{-1} at 8 TeV recorded by the ATLAS detector at the CERN Large Hadron Collider. No significant excess over the background prediction is observed and upper limits are set on the $t\bar{t}H$ production cross section. The observed exclusion upper limit at 95% confidence level is 6.7 times the predicted Standard Model cross section value. In addition, limits are set on the strength of the Yukawa coupling between the top quark and the Higgs boson, taking into account the dependence of the $t\bar{t}H$ and tH cross sections as well as the $H \rightarrow \gamma\gamma$ branching fraction on the Yukawa coupling. Lower and upper limits at 95% confidence level are set at -1.3 and $+8.0$ times the Yukawa coupling strength in the Standard Model.

Keywords: Higgs boson, diphoton decay, $t\bar{t}H$, top quark, Yukawa coupling, tH

1. Introduction

After the decades-long search for the Higgs boson [1–3], a particle consistent with the Standard Model (SM) Higgs boson has been discovered at the Large Hadron Collider (LHC) [4, 5]. A notable property of the SM Higgs boson is its predicted large Yukawa coupling to top quarks, Y_t^{SM} . The measurement of Y_t is particularly important for understanding electroweak symmetry breaking and allows for testing theories beyond the SM (BSM).

The value of Y_t is indirectly tested by measurements sensitive to gluon fusion, ggF, the dominant Higgs boson production mechanism at the LHC, which receives large contributions from loop diagrams involving the top quark. In addition, Y_t is probed in the decay of the Higgs boson to two photons, $H \rightarrow \gamma\gamma$, as the decay width also involves loop diagrams with top quarks [6]. However, Y_t can be directly measured in the production of top–antitop quark pairs, $t\bar{t}$, in association with a Higgs boson [7–11], $t\bar{t}H$.

The production of the Higgs boson in association with a single top quark, tH ,¹ is also sensitive to Y_t . Three processes contribute to tH production [12–16]: t -channel ($tHqb$) production, WtH production and s -channel tH production. The s -channel production is neglected in this Letter due to the much smaller cross section compared to $tHqb$ and WtH production. Examples of Feynman diagrams for $tHqb$ and WtH production are shown in Fig. 1.

In the SM, tH production is suppressed by the destructive interference between t -channel diagrams with Higgs bosons emitted from top quark and W boson lines, as for example shown in

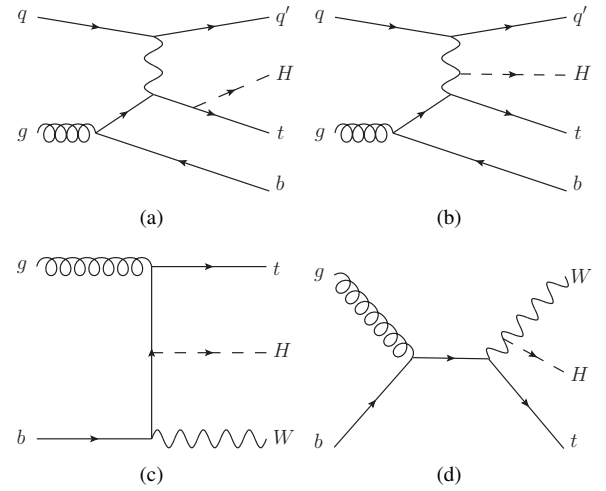

Fig. 1: Feynman diagrams showing examples for $tHqb$ (a, b) and WtH production (c, d). Higgs boson radiation off top quark and W boson lines is depicted. The $tHqb$ process is shown in the four-flavor scheme where no b -quarks are assumed to be present in the proton [17].

Fig. 1 (a) and Fig. 1 (b). In BSM theories [13–16], however, Y_t can have non-SM values, and in particular the relative sign between Y_t and g_{HWW} , which quantifies the coupling between the Higgs boson and the W boson, can be different from the SM prediction, which could lead to constructive instead of destructive interference in tH production. Hence, the tH production cross section is not only sensitive to the magnitude of Y_t but, in contrast to $t\bar{t}H$ production, it is also sensitive to the relative sign of Y_t with respect to g_{HWW} . A scale factor, κ_t , is introduced to

¹ For simplicity, tH refers equally to $t\bar{t}H$ in this Letter.

describe the relation between Y_t and its SM value: $Y_t = \kappa_t Y_t^{\text{SM}}$. Values of $\kappa_t \neq 1$ imply modifications of the Brout–Englert–Higgs mechanism and are assumed here to leave the top quark mass and decay properties unchanged. Furthermore, only SM particles are assumed to contribute to the decay width of the Higgs boson.

This Letter reports a search for $H \rightarrow \gamma\gamma$ in association with top quarks using data recorded with the ATLAS detector [18]. Measurements in the $H \rightarrow \gamma\gamma$ decay channel are challenging due to the small branching fraction in the SM, $\text{BR}(H \rightarrow \gamma\gamma) = 2.28 \times 10^{-3}$ for Higgs boson masses, m_H , around 125 GeV. However, the diphoton final state allows the diphoton invariant mass, $m_{\gamma\gamma}$, to be reconstructed with excellent resolution, strongly reducing the contribution from the backgrounds, which have a falling $m_{\gamma\gamma}$ spectrum, referred to as continuum background in the following. The contribution from the continuum background can be derived from data sidebands, thus not relying on theory assumptions. A previous search for $t\bar{t}H$ production by the CMS Collaboration has explored hadronic, diphoton and leptonic final states of the Higgs boson [19], setting an upper limit at the 95% confidence level (CL) on the ratio of the observed $t\bar{t}H$ production cross section to the SM expectation, called the signal strength $\mu_{t\bar{t}H}$, of 4.5.

This Letter also reports lower and upper limits at 95% CL on κ_t , taking into account the changes in the $t\bar{t}H$ and tH cross sections as well as the $H \rightarrow \gamma\gamma$ branching fraction [14–16]. BSM theories with values of $Y_t \neq Y_t^{\text{SM}}$ are hence constrained.

2. The ATLAS detector

The ATLAS detector consists of an inner tracking detector system, electromagnetic and hadronic calorimeters, and an external muon spectrometer. Charged particles in the pseudorapidity² range $|\eta| < 2.5$ are reconstructed with the inner tracking detector, which is immersed in a 2 T axial field provided by a superconducting solenoid, and consists of pixel and microstrip semiconductor detectors, as well as a straw-tube transition radiation tracker. The solenoid is surrounded by sampling calorimeters, which span the pseudorapidity range up to $|\eta| = 4.9$. High-granularity liquid-argon (LAr) electromagnetic calorimeters are present up to $|\eta| = 3.2$. Hadronic calorimeters with scintillator tiles as active material cover $|\eta| < 1.74$, while LAr technology is used for hadronic calorimetry from $|\eta| = 1.5$ to $|\eta| = 4.9$. Outside the calorimeter system, air-core toroids provide a magnetic field for the muon spectrometer. Three stations of precision drift tubes and cathode strip chambers provide a measurements of muon tracks in the region $|\eta| < 2.7$. Resistive-plate and thin-gap chambers provide muon triggering

²ATLAS uses a right-handed coordinate system with its origin at the nominal interaction point (IP) in the centre of the detector and the z -axis along the beam pipe. The x -axis points from the IP to the centre of the LHC ring, and the y -axis points upward. Cylindrical coordinates (r, ϕ) are used in the transverse plane, ϕ being the azimuthal angle around the beam pipe. The pseudorapidity is defined in terms of the polar angle θ as $\eta = -\ln \tan(\theta/2)$. The transverse momentum is defined as $p_T = p \sin \theta = p / \cosh \eta$, and the transverse energy E_T has an analogous definition.

capability up to $|\eta| < 2.4$. A detailed description of the ATLAS detector can be found in Ref. [18].

3. Data and Monte Carlo samples

3.1. Data samples

Data used for this analysis were recorded in pp collisions at $\sqrt{s} = 7$ TeV and 8 TeV in 2011 and 2012, respectively. All events satisfy data quality requirements ensuring proper functioning of the detector and trigger subsystems. The resulting datasets correspond to integrated luminosities of 4.5 fb^{-1} and 20.3 fb^{-1} , respectively [20]. For the 7 TeV dataset, events were triggered with a diphoton trigger with a threshold of 20 GeV on the transverse energy of each photon candidate. For the 8 TeV dataset, these thresholds were raised to 35 GeV for the highest- E_T (leading) photon candidate and 25 GeV for the second-highest- E_T (subleading) photon candidate.

3.2. Monte Carlo samples

The contribution from the continuum background is directly estimated from data. All processes involving $H \rightarrow \gamma\gamma$ decays, however, are estimated using Monte Carlo (MC) simulation samples.

The production of $t\bar{t}H$ events is modeled using next-to-leading-order (NLO) matrix elements obtained with the HELAC-Oneloop package [21], where POWHEG-BOX [22–24] is interfaced to PYTHIA 8.1 [25] for showering and hadronization. CT10 [26] parton distribution functions (PDF) and the AU2 underlying event tune [27, 28] are used. Production of $tHqb$ is simulated with MADGRAPH [29] in the four-flavor scheme with the CT10 PDF set, which provides a better description of the kinematics of the spectator b -quark than the five-flavor scheme [17]. PYTHIA 8.1 is used for showering and hadronization. Production of WtH is simulated in the five-flavor scheme by MADGRAPH5_AMC@NLO [30] interfaced to Herwig++ [31] using the CT10 PDF set. All tH samples are produced for three different values of κ_t : -1 , 0 and $+1$. In the simulation of $t\bar{t}H$, $tHqb$ and WtH processes, diagrams with Higgs bosons radiated in the top quark decay are not taken into account because such contributions are negligible [32].

Higgs boson production by ggF and vector-boson fusion (VBF) is simulated with POWHEG-BOX [33, 34] interfaced to PYTHIA 8.1 for showering and hadronization with CT10 PDF. Production of a Higgs boson in association with a W or Z boson (WH , ZH) is simulated with PYTHIA 8.1 using CTEQ6L1 [35] PDF.

All MC samples are generated at $m_H = 125$ GeV and are passed through a full GEANT4 [36] simulation of the ATLAS detector [37]. The simulated samples have additional pp collision events, pile-up, simulated by PYTHIA 8.1 added and weighted such that the average number of interactions per bunch-crossing is the same as in data.

The cross sections for $t\bar{t}H$ production were calculated at NLO in quantum chromodynamics (QCD) [7, 9, 38, 39]. The cross sections for $tHqb$ production are calculated for different values of κ_t at LO using MADGRAPH with the renormalization and

factorization scales set to 75 GeV, and with a minimum $p_{T,q}$ requirement of 10 GeV, consistent with the generated MC samples. LO-to-NLO K-factors are obtained by comparing the LO cross sections with the NLO cross sections calculated using MADGRAPH5_AMC@NLO. The cross sections for WtH production are calculated for different values of κ_t at NLO using MADGRAPH5_AMC@NLO with dynamic renormalization and factorization scales. Interference effects with $t\bar{t}H$ production are not considered, but are believed to be small given that WtH is produced mostly without a second high- p_T b -quark in the final state.

The cross sections for ggF production were calculated at next-to-next-to-leading order (NNLO) in QCD [40–45]. In addition, QCD soft-gluon resummation up to next-to-next-to-leading logarithms [46] is adopted to improve the NNLO calculation, and NLO electroweak (EW) corrections are applied [47, 48]. The cross sections for VBF production were calculated including NLO QCD and EW corrections [49–51]. In addition, approximate NNLO QCD corrections are applied [52]. The cross sections for WH and ZH production were calculated at NLO [53] and NNLO [54] in QCD. Moreover, NLO EW corrections [55] are applied.

The theoretical uncertainties on the Higgs boson production cross sections come from varying the renormalization and factorization scales and from uncertainties on the parton distribution functions [26, 56–58]. The Higgs boson decay branching fractions are taken from Refs. [59–62] and their uncertainties are compiled in Refs. [63, 64]. A summary of the cross-section values and their uncertainties is given in Table 1.

Table 1: Production cross sections for the various Higgs boson processes at 7 TeV and 8 TeV before taking into account the $\text{BR}(H \rightarrow \gamma\gamma)$ at $m_H = 125$ GeV. Also quoted are the theoretical uncertainties from variations of the renormalization and factorization scales and uncertainties on the parton distribution functions [63, 64].

Process	σ [pb] at 7 TeV	σ [pb] at 8 TeV
$t\bar{t}H$	$0.086^{+0.008}_{-0.011}$	$0.129^{+0.012}_{-0.016}$
$tHqb, \kappa_t = +1$	$0.0111^{+0.0009}_{-0.0008}$	$0.0172^{+0.0012}_{-0.0011}$
$tHqb, \kappa_t = 0$	$0.040^{+0.003}_{-0.003}$	$0.059^{+0.004}_{-0.004}$
$tHqb, \kappa_t = -1$	$0.129^{+0.010}_{-0.009}$	$0.197^{+0.014}_{-0.013}$
$WtH, \kappa_t = +1$	$0.0029^{+0.0007}_{-0.0006}$	$0.0047^{+0.0010}_{-0.0009}$
$WtH, \kappa_t = 0$	$0.0043^{+0.0011}_{-0.0008}$	$0.0073^{+0.0017}_{-0.0013}$
$WtH, \kappa_t = -1$	$0.016^{+0.004}_{-0.003}$	$0.027^{+0.006}_{-0.005}$
ggF	15.1 ± 1.6	19.3 ± 2.0
VBF	1.22 ± 0.03	1.58 ± 0.04
WH	0.579 ± 0.016	0.705 ± 0.018
ZH	0.335 ± 0.013	0.415 ± 0.017

4. Object and event selection

4.1. Object selection

Photons are reconstructed [65] from clusters of cells in the electromagnetic calorimeter in the region $|\eta| < 2.37$ exclud-

ing the transition region, $1.37 < |\eta| < 1.56$, between the barrel and endcap calorimeters. Unconverted photons are required to have no tracks associated with them; clusters from photons converted in the material between the production vertex and the calorimeter are allowed to have one or two associated tracks. The energies of the clusters are calibrated, separately for unconverted and converted photon candidates, in order to account for energy losses upstream of the calorimeter and for energy leakage outside of the cluster. Photons are required to pass a set of selection requirements on the reconstructed shower shape as well as the following isolation requirements: the sum of the p_T of all particles featuring tracks with $p_T > 1$ GeV in a cone of size $\Delta R \equiv \sqrt{(\Delta\eta)^2 + (\Delta\phi)^2} = 0.2$ around the photon is required to be smaller than 2.6 (2.2) GeV for the $\sqrt{s} = 8$ TeV (7 TeV) data. Tracks from converted photons are excluded from the sum. Moreover, the sum of the E_T values in the calorimeter cells in a cone of size $\Delta R = 0.4$ around the photon is required to be smaller than 6 (5.5) GeV for the 8 TeV (7 TeV) data. The calorimeter isolation is corrected for photon energy leakage. It is also corrected event-by-event by using the ambient energy from pile-up and the underlying event [66, 67]. Only events with two photons are retained and a diphoton vertex is reconstructed by a neural-network-based algorithm [68], which uses as input the trajectories of the two photons and the tracks associated with different vertex candidates. The photon trajectory is determined from the longitudinal profile of the photon shower in the calorimeter, the average pp collision point, and for converted photons from the direction of the associated tracks. The leading (subleading) photon is required to have $E_T > 0.35 \times m_{\gamma\gamma}$ ($0.25 \times m_{\gamma\gamma}$), and the diphoton mass is required to be between 105 GeV and 160 GeV.

Electrons are reconstructed [69] from clusters of cells in the electromagnetic calorimeter with an associated track. Only clusters in the region $|\eta| < 2.47$ are considered and are required to fulfill requirements on their shape to be consistent with an electron. The electron E_T has to be larger than 15 GeV. In addition, electrons must be isolated: the E_T in a cone of size $\Delta R = 0.4$ around the electron and the sum of the transverse momenta of the tracks in a cone of size $\Delta R = 0.2$ around the electron must be smaller than 20% and 15% of the electron E_T , respectively.

Muons are reconstructed [70] by combining tracks in the inner detector with tracks or track-segments in the muon spectrometer. Muons are required to satisfy $|\eta| < 2.7$ and $p_T > 10$ GeV and have to be isolated: muons closer than $\Delta R = 0.4$ to a jet or to one of the two photons are not considered. Moreover, the E_T in a cone of size $\Delta R = 0.4$ around the muon and the sum of the transverse momenta of the tracks in a cone of size $\Delta R = 0.2$ around the muon must be smaller than 20% and 15% of the muon p_T , respectively.

Jets are reconstructed from clusters of cells in the calorimeter with the anti- k_t algorithm [71] with a radius parameter of 0.4. They are calibrated to the hadronic energy scale [72], and only those with $p_T > 25$ GeV and $|\eta| < 2.5$ are considered. The jet energy is corrected for energy deposits from additional soft interactions in the event [73]. In order to suppress jets from

Table 2: Expected numbers of $H \rightarrow \gamma\gamma$ events (N_H) from an SM Higgs boson with $m_H = 125.4$ GeV after the event selection. These combined yields are normalized to 4.5 fb^{-1} for the 7 TeV data and to 20.3 fb^{-1} for the 8 TeV data, and are listed in the table along with the percent contribution of each Higgs boson production process with respect to the sum of all Higgs boson production processes. The numbers of fitted continuum background events (N_B) for the 7 TeV and 8 TeV data are also shown, where N_B is the integral of the continuum background in the $m_{\gamma\gamma}$ range 120–130 GeV, which is determined by an unbinned signal-plus-background fit to all categories with one common scale factor for the $H \rightarrow \gamma\gamma$ normalization. The uncertainty on N_B is the statistical uncertainty calculated from $\delta N_B = \delta N_{\text{tot}} N_B / N_{\text{tot}}$, where N_{tot} is the total number of background events in the full $m_{\gamma\gamma}$ range 105–160 GeV estimated from an unbinned signal-plus-background likelihood fit, and δN denotes the Poisson uncertainty on N .

Category	N_H	ggF	VBF	WH	ZH	$t\bar{t}H$	$tHqb$	WtH	N_B
7 TeV leptonic selection	0.10	0.6	0.1	14.9	4.0	72.6	5.3	2.5	$0.5^{+0.5}_{-0.3}$
7 TeV hadronic selection	0.07	10.5	1.3	1.3	1.4	80.9	2.6	1.9	$0.5^{+0.3}_{-0.3}$
8 TeV leptonic selection	0.58	1.0	0.2	8.1	2.3	80.3	5.6	2.6	$0.9^{+0.6}_{-0.4}$
8 TeV hadronic selection	0.49	7.3	1.0	0.7	1.3	84.2	3.4	2.1	$2.7^{+0.9}_{-0.7}$

additional interactions, the jet vertex fraction (JVF) must be larger than 50% for jets with $p_T < 50$ GeV and $|\eta| < 2.4$. The JVF is defined from the summed track p_T as the fraction associated with the primary diphoton vertex, where all tracks with $p_T > 0.5$ GeV matched to the jet are considered.

Jets containing b -quarks are identified with a neural-network-based b -tagging algorithm, which combines variables from impact parameter, secondary vertex and decay topology algorithms evaluating the track parameters associated with the jet [74]. Three different working points (WP) with efficiencies of 60%, 70% and 80% for identifying b -jets are used for 8 TeV data. For 7 TeV data, a slightly different optimization of the b -tagging algorithm with a WP corresponding to an efficiency of 85% is used. The b -tagging and mistagging efficiencies are measured in data using dijet and $t\bar{t}$ events [75].

The magnitude of the missing transverse momentum in each event, E_T^{miss} , is calculated using clusters of cells in the calorimeter. Corrections are applied for identified photons, electrons, muons and jets according to special E_T^{miss} object identification requirements [76].

In order to avoid double-counting of reconstructed objects, electrons with a distance in η - ϕ space smaller than 0.4 to one of the two photons, $\Delta R(e, \gamma)$, are not considered. In addition, jets with $\Delta R(\text{jet}, \gamma) < 0.4$ or $\Delta R(\text{jet}, e) < 0.2$ are removed.

4.2. Event selection

In addition to the requirement of two good photons satisfying the criteria described in Section 4.1, two different event selections were optimized in order to efficiently select leptonic $t\bar{t}H$ events (leptonic category) as well as all-hadronic $t\bar{t}H$ events (hadronic category). The optimization targeted an optimal expected limit on the signal strength $\mu_{t\bar{t}H}$ in case no evidence for $t\bar{t}H$ production is found. However, the requirements for the leptonic category are kept loose enough in order to also allow high selection efficiency for $tHqb$ and WtH production.

In this analysis, we assume that the top quark only decays to a W boson and a b -quark. The leptonic selection targets both the single-lepton decays of the $t\bar{t}$ pairs, where one of the W bosons decays leptonically and the other one decays hadronically, and the dilepton decays of $t\bar{t}$ pairs, where both W bosons decay leptonically. Events are selected by requiring at least one electron or muon, at least one b -tagged jet using the 80% (85%) WP for 8 TeV (7 TeV) data and $E_T^{\text{miss}} > 20$ GeV. The E_T^{miss} requirement

is imposed to reduce backgrounds from final states without top quarks and it is not used for events with two or more b -tagged jets. Events with an electron–photon invariant mass in the range 84–94 GeV are rejected in order to reduce the background contribution from $Z \rightarrow ee$ events with one electron misidentified as a photon.

The hadronic selection targets events where both W bosons, from the top quark decays, decay hadronically. No electrons or muons may be identified in the event. Events must fulfill requirements on the number of jets and the number of b -tagged jets. For the 8 TeV dataset three sets of requirements are defined, out of which at least one must be satisfied for an event to be considered:

1. At least six jets, out of which at least two must be b -tagged using the 80% WP.
2. At least five jets with an increased p_T threshold of 30 GeV, out of which at least two must be b -tagged using the 70% WP.
3. At least six jets with an increased p_T threshold of 30 GeV, out of which at least one must be b -tagged using the 60% WP.

These requirements were optimized to suppress in particular the contribution from ggF Higgs boson production with $H \rightarrow \gamma\gamma$ to the hadronic category, while retaining good sensitivity to $t\bar{t}H$ production. For the 7 TeV dataset only events with at least six jets, at least two of which are b -tagged with the 85% WP, are considered.

Table 2 summarizes the expected numbers of events in each category for $m_H = 125.4$ GeV, the Higgs boson mass measured by the ATLAS Collaboration [68]. The breakdown into the different Higgs boson production processes is given. The combined selection efficiencies in the 7 TeV and 8 TeV data for $t\bar{t}H$ production at $m_H = 125.4$ GeV are approximately 14.6% and 14.8%, respectively. For SM $tHqb$ (WtH) production the combined selection efficiencies for 7 TeV and 8 TeV are approximately 6.2% (12.9%) and 6.2% (11.9%), respectively.

5. Analysis

In order to separate processes involving $H \rightarrow \gamma\gamma$ decays from the continuum background, a localized excess of events is searched for in the $m_{\gamma\gamma}$ spectrum around $m_H = 125.4$ GeV.

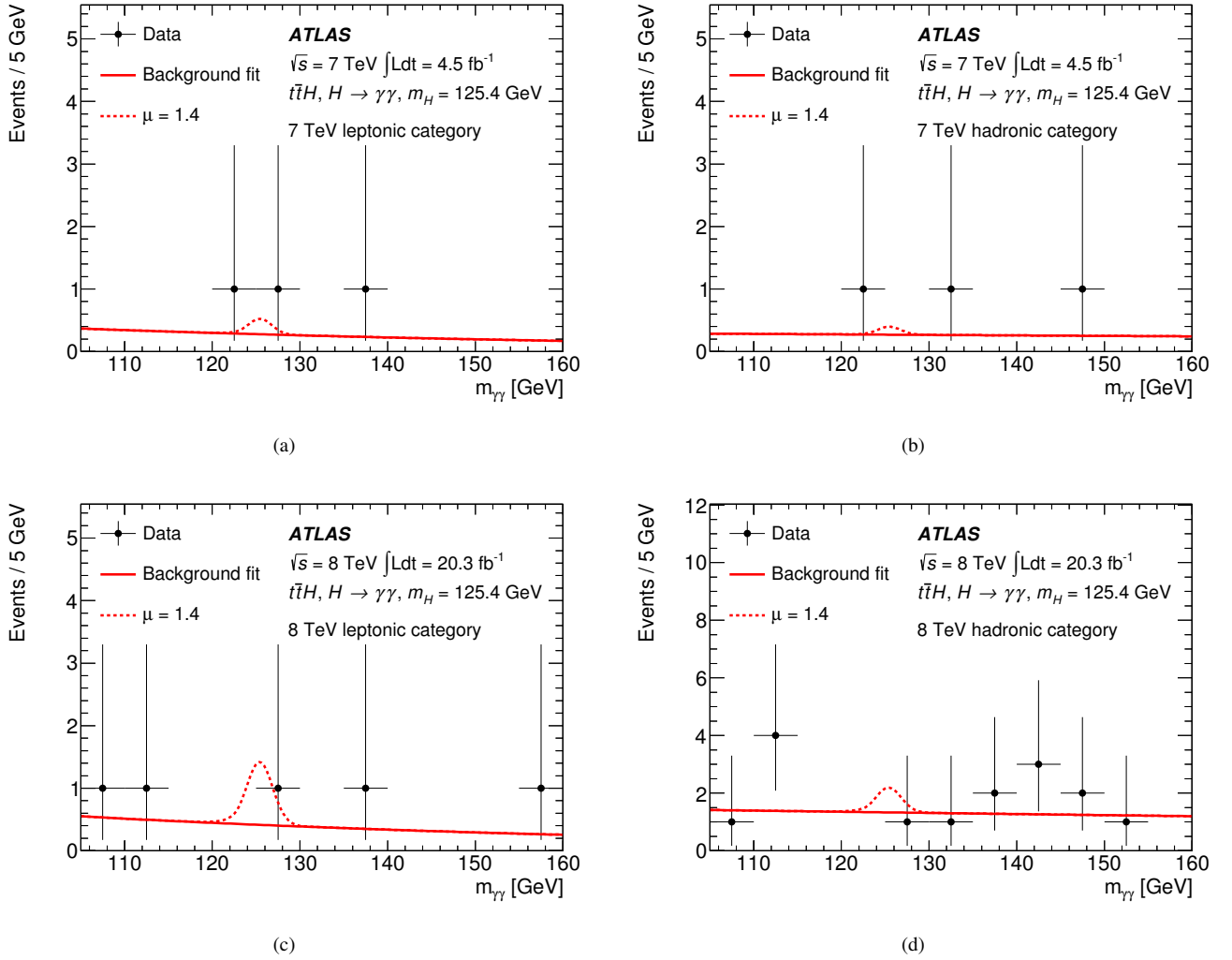

Fig. 2: Distributions of the diphoton invariant mass, $m_{\gamma\gamma}$, for the leptonic (left) and hadronic (right) category for data at 7 TeV (top) and data at 8 TeV (bottom). An unbinned signal-plus-background likelihood fit to the full spectra is used to estimate the number of events from continuum background (solid line) as well as from SM Higgs boson production (dashed line). The signal strength, μ , is a parameter common to all categories and its best-fit value is $\mu = 1.4$ for $m_H = 125.4$ GeV.

Probability distribution functions for the $H \rightarrow \gamma\gamma$ resonance and continuum background $m_{\gamma\gamma}$ distributions are defined in the range of 105–160 GeV as described below, and the numbers of Higgs boson and continuum background events are estimated from an unbinned signal-plus-background likelihood fit to the full $m_{\gamma\gamma}$ distributions in the leptonic and hadronic categories. Systematic uncertainties are taken into account as nuisance parameters, which are fitted within their external constraints.

The sum of a Crystal Ball function [77] and a Gaussian function is used to describe the $m_{\gamma\gamma}$ distribution from $H \rightarrow \gamma\gamma$ decays obtained from MC simulations [78]. The Gaussian function accounts only for a small fraction of the total $H \rightarrow \gamma\gamma$ resonance signal, describing small tails of the shape which cannot be characterized by the Crystal Ball function. The parameters of these functions are interpolated between the values fitted to a series of MC samples generated in steps of 5 GeV in m_H , in order to allow for the evaluation of the resonance shape for intermediate masses including $m_H = 125.4$ GeV, where MC

samples are not available. The relative fraction of the Gaussian component with respect to the full $H \rightarrow \gamma\gamma$ resonance shape is not varied as a function of m_H . Shapes with different parameter values are defined for the 7 TeV and 8 TeV data. The $m_{\gamma\gamma}$ resolution, which is quantified by half of the smallest $m_{\gamma\gamma}$ interval containing 68% of the signal events, is 1.42 GeV for the 7 TeV data and 1.56 GeV for the 8 TeV data in the leptonic categories. The values in the hadronic categories are consistent with the ones in the leptonic categories within statistical uncertainties. The small difference in $m_{\gamma\gamma}$ resolution between 7 TeV and 8 TeV is due to a difference in the effective constant term for the calorimeter energy resolution and due to the lower level of pile-up in the 7 TeV data [68]. The $m_{\gamma\gamma}$ resolution is dominated by the photon energy resolution. The small change in acceptance for $t\bar{t}H$ production is interpolated using MC samples generated with different hypothesized values of m_H also. For all other Higgs boson production processes, the difference

Table 3: Summary of systematic uncertainties on the final yield of events for 8 TeV data from $t\bar{t}H$, $tHqb$ and WtH production after applying the leptonic and hadronic selection requirements. The uncertainties are also shown for other Higgs boson production processes that do not include the associated production of top quarks and have significant contributions to the event selection. These are WH production in the leptonic category and ggF production in the hadronic category. For both tH production processes, the maximum uncertainty observed for all values of κ_t generated (+1, 0, -1) is reported.

	$t\bar{t}H$ [%]		$tHqb$ [%]		WtH [%]		ggF [%]	WH [%]
	had.	lep.	had.	lep.	had.	lep.	had.	lep.
Luminosity	±2.8							
Photons	±5.6	±5.5	±5.6	±5.5	±5.6	±5.5	±5.6	±5.5
Leptons	< 0.1	±0.7	< 0.1	±0.6	< 0.1	±0.6	< 0.1	±0.7
Jets and E_T^{miss}	±7.4	±0.7	±16	±1.9	±11	±2.1	±29	±10
Bkg. modeling	0.24 evt.	0.16 evt.	applied on the sum of all Higgs boson production processes					
Theory ($\sigma \times \text{BR}$)	+10, -13		+7, -6		+14, -12		+11, -11	+5.5, -5.4
MC modeling	±11	±3.3	±12	±4.4	±12	±4.6	±130	±100

in acceptance between $m_H = 125$ GeV and $m_H = 125.4$ GeV is found to be negligible.

An exponential function, $e^{am_{\gamma\gamma}}$, with $a \leq 0$ is chosen for both categories as a model for the continuum background following the method previously used in Ref. [5]. The choice of fit function is validated in data control regions obtained by loosening the photon identification and isolation requirements. These control regions are dominated by jets misidentified as photons, and the systematic uncertainties derived from these control regions (cf. Section 6) are hence only approximate. In both the leptonic and the hadronic category, the same continuum background shape is used for 7 TeV and 8 TeV data, because the 7 TeV data alone is not expected to strongly constrain the parameter a given the expected low number of events.

In the range $105 \text{ GeV} < m_{\gamma\gamma} < 160 \text{ GeV}$, 3 (3) events are found in the leptonic (hadronic) category in the 7 TeV and 5 (15) events are found in the 8 TeV data. The results of the fits for the leptonic and hadronic categories are shown in Fig. 2, separately for 7 TeV and 8 TeV data. The fitted numbers of continuum background events in a window of 120–130 GeV are shown in Table 2.

6. Systematic uncertainties

Systematic uncertainties from various sources affect both the expected number of events for different Higgs boson production processes and the $m_{\gamma\gamma}$ resonance shape. An overview of all systematic uncertainties for 8 TeV data is shown in Table 3 for $t\bar{t}H$, $tHqb$ and WtH production. The uncertainties are also shown for other Higgs boson production processes that do not include the associated production of top quarks and have significant contributions to the event selection. These are WH production in the leptonic category and ggF production in the hadronic category.

The uncertainty on the integrated luminosity is 2.8% (1.8%) for the 8 TeV (7 TeV) data as derived following the same methodology as that detailed in Ref. [20] using beam-separation scans. For 8 TeV data, the trigger efficiency [79] was measured to be $99.5 \pm 0.2\%$. For 7 TeV data, the efficiency was measured to be compatible with 100% within an uncertainty of 0.2%. The uncertainty in the combined diphoton identification efficiency is 1.0% (8.4%) [80] for 8 TeV (7 TeV) data. Due

to the high jet multiplicity in this analysis an additional uncertainty of 4% is added to account for possible mismodeling of the photon identification efficiency. This additional uncertainty is obtained from data–MC comparisons of electron efficiencies in $Z(\rightarrow ee)$ +jets events, where photon identification requirements are applied to the electron clusters [81]. Analogously, an additional uncertainty of 3% is assessed for the efficiency of the combined diphoton isolation requirement, and is added in quadrature to the nominal uncertainty of 2.3% (2.1%) in the hadronic (leptonic) category. The uncertainty on the photon energy scale [80] was found to have a negligible effect on the expected yields. Its effect on the peak position, however, is taken into account, but has a negligible impact on the results. The uncertainty in the photon energy resolution translates into an uncertainty on the $m_{\gamma\gamma}$ resolution, and is based on the resolution measured with $Z \rightarrow ee$ events [80]. The total $m_{\gamma\gamma}$ resolution uncertainty is 12% for both the 7 TeV and 8 TeV dataset, which is less than 0.2 GeV.

The uncertainties due to the lepton reconstruction, identification, isolation, and energy/momentum scale and resolution combine to less than 1% for all channels. Uncertainties on the jet energy scale are taken into account, as well as uncertainties on the jet energy resolution, and on the modeling of the JVF and of the b -tagging efficiencies. All object uncertainties which change the energy or momentum of the corresponding objects are propagated to the E_T^{miss} calculation, and additional uncertainties are taken into account for energy deposits which only enter the E_T^{miss} calculation, but are not part of other objects.

Systematic uncertainties due to the choice of the continuum background fit model are estimated by fitting continuum background distributions in control regions with a Higgs boson plus continuum background model and quantifying the apparent number of Higgs boson events introduced [5]. The systematic uncertainty is chosen to be the maximal apparent number of Higgs boson events in a narrow mass range around 125.4 GeV. Since the contributions from different background processes in the control region may be different from their contributions in the four categories, the estimate of this uncertainty is approximate, but its impact on the final results is very small. An uncertainty of 0.24 (0.16) events is estimated in the 8 TeV hadronic (leptonic) category as the apparent number of Higgs boson

events under the Higgs boson peak. For the 7 TeV dataset, uncertainties of 0.12 and 0.01 events are estimated, where all of these numbers have a non-negligible statistical component from the limited number of events in the control regions considered. The number of events is lowest in the control region for the hadronic category in 7 TeV data (266 events).

The theoretical uncertainties on the different Higgs boson production cross sections due to uncertainties in the PDF, missing higher-order perturbative QCD corrections estimated by varying the renormalization and factorization scales, and the $\text{BR}(H \rightarrow \gamma\gamma)$ are detailed in Refs. [26, 56–58, 62–64, 82].

Additional uncertainties are included in “MC modeling” in Table 3. These take into account changes in the acceptance when the renormalization and factorization scales are varied, an uncertainty on the modeling of the underlying event, which is conservatively estimated by comparing MC samples with and without multiple parton scattering, and an uncertainty due to the limited number of events present in the MC samples after the event selection and categorization are applied. Moreover, uncertainties of 100% are assigned to the expected numbers of events from ggF, VBF and WH production in association with additional b -jets. The size of these uncertainties is motivated by recent measurements of $t\bar{t}$ and vector-boson production in association with b -jets [83, 84].

7. Results

In total, 5 candidate events with $m_{\gamma\gamma}$ in the range 120–130 GeV are found in the leptonic and hadronic categories. The total expected yield of Higgs boson production is 1.3 events compared to a continuum background of $4.6^{+1.3}_{-0.9}$ events (see Table 2). The $m_{\gamma\gamma}$ spectra for the candidate events are shown in Fig. 2 together with the fitted continuum background and the total contribution from $H \rightarrow \gamma\gamma$ processes, where the signal strength, μ , is a parameter common to all four categories. The best-fit signal strength for all $H \rightarrow \gamma\gamma$ processes together is $1.4^{+2.1}_{-1.4}(\text{stat.})^{+0.6}_{-0.3}(\text{syst.})$, where the quoted overall systematic uncertainty is derived by quadratically subtracting the statistical uncertainty from the total uncertainty. When the yields for all $H \rightarrow \gamma\gamma$ processes, including tH production but not $t\bar{t}H$ production, are set to their respective SM expected number of events, a best-fit value of $1.3^{+2.5}_{-1.7}(\text{stat.})^{+0.8}_{-0.4}(\text{syst.})$ is obtained for $\mu_{t\bar{t}H}$, which is also shown in the scan of the likelihood in Fig. 3. This best-fit value of $\mu_{t\bar{t}H}$ is consistent with the SM expectation of one, but does not represent a significant excess over the predicted background rate, and CL_s -based [85] 95% CL exclusion upper limits are set for $t\bar{t}H$ production times $\text{BR}(H \rightarrow \gamma\gamma)$. Limits are set using the asymptotic formulae discussed in Ref. [86] with the profile likelihood ratio as test statistic. The results are found to be consistent with limits derived from ensembles of pseudo-experiments. The observed and expected upper limits for $\mu_{t\bar{t}H}$ at $m_H = 125.4$ GeV are summarized in Fig. 4 as well as in Table 4, where the expected limits assume $\mu_{t\bar{t}H} = 0$. The non- $t\bar{t}H$ Higgs boson production modes, including tH , are fixed to their SM expectations with corresponding theory and experimental uncertainties assigned. An upper limit of 6.7 times the SM cross section times

$\text{BR}(H \rightarrow \gamma\gamma)$ is observed. Upper limits at 95% CL are also set on the signal strength of the sum of all $H \rightarrow \gamma\gamma$ processes, μ , and the observed (expected) limit is 5.7 (3.8).

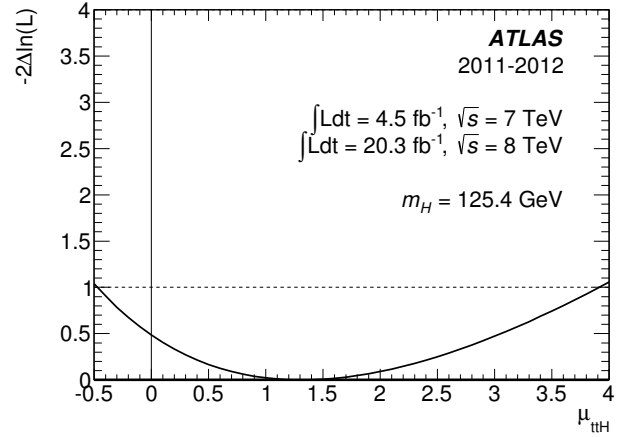

Fig. 3: Negative log-likelihood scan for the $t\bar{t}H$ cross section times $\text{BR}(H \rightarrow \gamma\gamma)$ relative to the SM expectation, $\mu_{t\bar{t}H}$, at $m_H = 125.4$ GeV, where all other Higgs boson production cross sections, including the cross section for tH production, are set to their respective SM expectations.

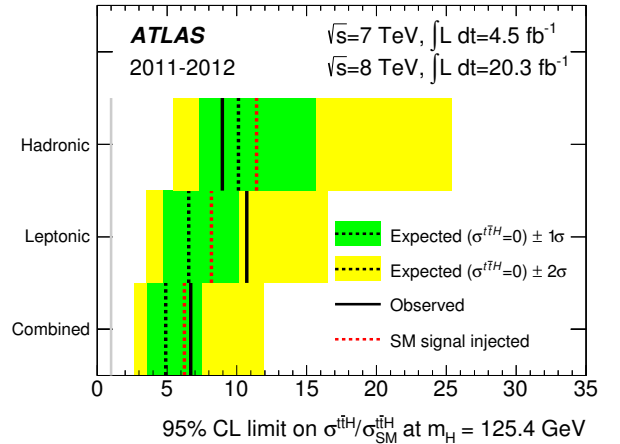

Fig. 4: Observed and expected 95% CL upper limits on the $t\bar{t}H$ production cross section times $\text{BR}(H \rightarrow \gamma\gamma)$. All other Higgs boson production cross sections, including the cross section for tH production, are set to their respective SM expectations. While the expected limits are calculated for the case where $t\bar{t}H$ production is not present, the lines denoted by “SM signal injected” show the expected 95% CL limits for a dataset corresponding to continuum background plus SM Higgs boson production. The limits are given relative to the SM expectations and at $m_H = 125.4$ GeV.

These results are also interpreted as 95% CL limits on the strength parameter κ_t of the top quark–Higgs boson Yukawa coupling. Variations in κ_t not only change the production cross sections of the $t\bar{t}H$ and tH processes, but also affect $\text{BR}(H \rightarrow \gamma\gamma)$, and the cross sections of the other Higgs boson production processes [82]. Fig. 5 illustrates the dependence of the $t\bar{t}H$ and tH cross sections and of the $\text{BR}(H \rightarrow \gamma\gamma)$ on κ_t . For $\kappa_t = 0$, the $t\bar{t}H$ process is turned off, and the top quark contribution to tH production and to the loop-induced $H \rightarrow \gamma\gamma$ decay is

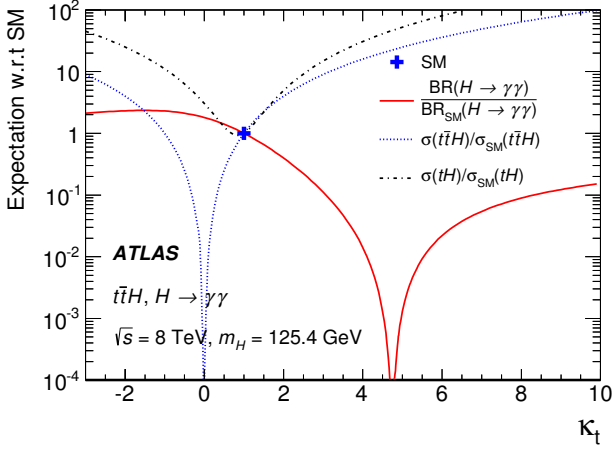

Fig. 5: Production cross sections for $t\bar{t}H$ and tH divided by their SM expectations as a function of the scale factor to the top quark-Higgs boson Yukawa coupling, κ_t . Production of tH comprises the $tHqb$ and WtH processes. Also shown is the dependence of the $BR(H \rightarrow \gamma\gamma)$ with respect to its SM expectation on κ_t .

moved, leaving mainly the contribution from W bosons. For values of $\kappa_t < 0$, on the other hand, the interference between contributions from W bosons and top quarks to tH production and to the $BR(H \rightarrow \gamma\gamma)$ becomes constructive, thus enhancing the two processes with respect to their respective SM expectations. Cancellations of the contributions of top quarks and W bosons to the loop-induced $H \rightarrow \gamma\gamma$ decay lead to a minimum of the $BR(H \rightarrow \gamma\gamma)$ around a value of $\kappa_t = +4.7$. The combined selection efficiency differs slightly for the three values of κ_t for which $tHqb$ and WtH MC samples were generated. From these, the efficiency at different values of κ_t in the range $[-3, +10]$ is calculated by combining reweighted MC samples with $\kappa_t = +1, 0$ and -1 . The weight for each sample is assigned in such a way that the cross-section value from the combination follows the prediction shown in Fig. 5. The largest relative difference with respect to the efficiency at $\kappa_t = +1$ over the entire range is found to be 14% (20%) for $tHqb$ (WtH) production.

All $H \rightarrow \gamma\gamma$ processes are considered and 95% CL limits are set on the total Higgs boson production cross section times $BR(H \rightarrow \gamma\gamma)$ with respect to the SM cross section for different values of κ_t . Coupling strengths other than κ_t are set to their re-

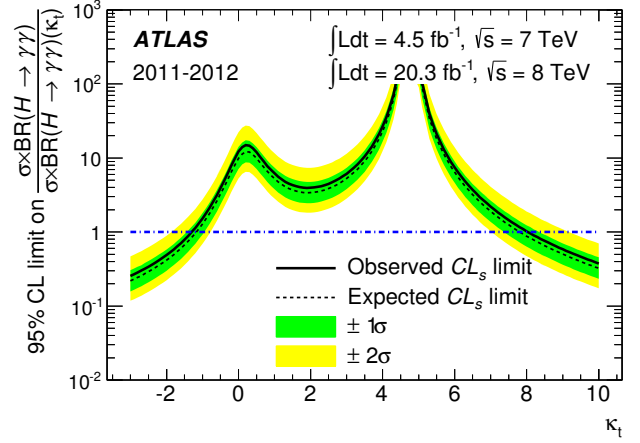

Fig. 6: Observed and expected 95% CL upper limits on the inclusive Higgs boson production cross section with respect to the cross section times $BR(H \rightarrow \gamma\gamma)$ for different values of κ_t at $m_H = 125.4$ GeV, where κ_t is the strength parameter for the top quark-Higgs boson Yukawa coupling. All Higgs boson production processes are considered for the inclusive production cross section. The expected limits are calculated for the case where $\kappa_t = +1$. The CL_s alternative hypothesis is given by continuum background plus SM Higgs boson production.

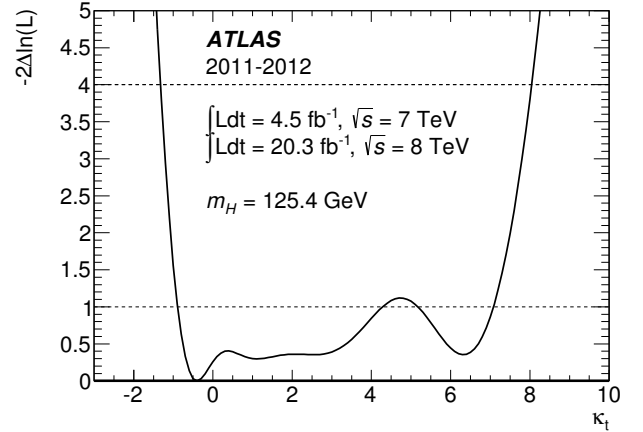

Fig. 7: Negative log-likelihood scan of κ_t at $m_H = 125.4$ GeV, where κ_t is the strength parameter for the top quark-Higgs boson Yukawa coupling.

Table 4: Observed and expected 95% CL upper limits on the $t\bar{t}H$ production cross section times $BR(H \rightarrow \gamma\gamma)$ relative to the SM cross section times $BR(H \rightarrow \gamma\gamma)$ at $m_H = 125.4$ GeV. All other Higgs boson production cross sections, including the cross section for tH production, are set to their respective SM expectations. In addition, the expected limits corresponding to $+2\sigma, +1\sigma, -1\sigma$, and -2σ variations are shown. The expected limits are calculated for the case where $t\bar{t}H$ production is not present. The results are given for the combination of leptonic and hadronic categories with all systematic uncertainties included, and also for leptonic and hadronic categories separately, as well as for the expected limits additionally with only statistical uncertainties considered.

	Observed limit	Expected limit	$+2\sigma$	$+1\sigma$	-1σ	-2σ
Combined (with systematics)	6.7	4.9	11.9	7.5	3.5	2.6
Combined (statistics only)		4.7	10.5	7.0	3.4	2.5
Leptonic (with systematics)	10.7	6.6	16.5	10.1	4.7	3.5
Leptonic (statistics only)		6.4	15.1	9.6	4.6	3.4
Hadronic (with systematics)	9.0	10.1	25.4	15.6	7.3	5.4
Hadronic (statistics only)		9.5	21.4	14.1	6.8	5.1

spective SM values. The continuum background plus SM Higgs boson production ($\kappa_t = +1$) is taken as alternative hypothesis.

The observed and expected limits on κ_t at $m_H = 125.4$ GeV are summarized in Fig. 6, where the observed (expected) lower and upper limits on κ_t at 95% CL are -1.3 and $+8.0$ (-1.2 and $+7.8$). The expected limits assume $\kappa_t = +1$. The form of the limit curve shown in Fig. 6 is the result of the different dependencies of the different Higgs boson production processes as well as the $\text{BR}(H \rightarrow \gamma\gamma)$ on κ_t . The negative log-likelihood scan of κ_t is shown in Fig. 7 and it shows that the data are consistent with the SM expectation of $\kappa_t = +1$. Although two different values of κ_t exist with the same total number of expected events, there are no double minima at zero shown in Fig. 6 because different relative contributions from the Higgs boson production processes in different categories have lifted the degeneracy of the likelihood.

8. Conclusion

A search for Higgs boson production in association with top quarks in the $H \rightarrow \gamma\gamma$ decay channel is presented using leptonic and hadronic $t\bar{t}$ decays. Data at 7 TeV and 8 TeV corresponding to 4.5 fb^{-1} and 20.3 fb^{-1} taken in pp collisions with the ATLAS detector at the LHC were analyzed. No significant excess over the background prediction is observed and upper limits at 95% CL are set on the $t\bar{t}H$ production cross section. The observed exclusion limit at $m_H = 125.4$ GeV is found to be 6.7 times the predicted SM cross section. The corresponding lower and upper limits on the top quark–Higgs boson Yukawa coupling strength parameter κ_t are found to be -1.3 and $+8.0$, which in particular constrain models with a negative sign of the coupling.

9. Acknowledgements

We thank CERN for the very successful operation of the LHC, as well as the support staff from our institutions without whom ATLAS could not be operated efficiently.

We acknowledge the support of ANPCyT, Argentina; Yerevan PhI, Armenia; ARC, Australia; BMWFW and FWF, Austria; ANAS, Azerbaijan; SSTC, Belarus; CNPq and FAPESP, Brazil; NSERC, NRC and CFI, Canada; CERN; CONICYT, Chile; CAS, MOST and NSFC, China; COLCIENCIAS, Colombia; MSMT CR, MPO CR and VSC CR, Czech Republic; DNRF, DNSRC and Lundbeck Foundation, Denmark; EPLANET, ERC and NSRF, European Union; IN2P3-CNRS, CEA-DSM/IRFU, France; GNSF, Georgia; BMBF, DFG, HGF, MPG and AvH Foundation, Germany; GSRT and NSRF, Greece; ISF, MINERVA, GIF, I-CORE and Benoziyo Center, Israel; INFN, Italy; MEXT and JSPS, Japan; CNRST, Morocco; FOM and NWO, Netherlands; BRF and RCN, Norway; MNiSW and NCN, Poland; GRICES and FCT, Portugal; MNE/IFA, Romania; MES of Russia and ROSATOM, Russian Federation; JINR; MSTD, Serbia; MSSR, Slovakia; ARRS and MIZŠ, Slovenia; DST/NRF, South Africa; MINECO, Spain; SRC and Wallenberg Foundation, Sweden; SER, SNSF and Cantons of Bern and Geneva, Switzerland; NSC, Taiwan; TAEK, Turkey; STFC, the Royal Society and Leverhulme Trust, United Kingdom; DOE and NSF, United States of America.

The crucial computing support from all WLCG partners is acknowledged gratefully, in particular from CERN and the ATLAS Tier-1 facilities at TRIUMF (Canada), NDGF (Denmark, Norway, Sweden), CC-IN2P3 (France), KIT/GridKA (Germany), INFN-CNAF (Italy), NL-T1 (Netherlands), PIC (Spain), ASGC (Taiwan), RAL (UK) and BNL (USA) and in the Tier-2 facilities worldwide.

References

- [1] F. Englert, R. Brout, Broken symmetry and the mass of gauge vector mesons, *Phys. Rev. Lett.* 13 (1964) 321. doi:10.1103/PhysRevLett.13.321.
- [2] P. W. Higgs, Broken symmetries and the masses of gauge bosons, *Phys. Rev. Lett.* 13 (1964) 508. doi:10.1103/PhysRevLett.13.508.
- [3] G. Guralnik, C. Hagen and T. Kibble, Global conservation laws and massless particles, *Phys. Rev. Lett.* 13 (1964) 585.
- [4] CMS Collaboration, Observation of a new boson at a mass of 125 GeV with the CMS experiment at the LHC, *Phys. Lett. B* 716 (2012) 30. arXiv:1207.7235, doi:10.1016/j.physletb.2012.08.021.
- [5] ATLAS Collaboration, Observation of a new particle in the search for the Standard Model Higgs boson with the ATLAS detector at the LHC, *Phys. Lett. B* 716 (2012) 1. arXiv:1207.7214, doi:10.1016/j.physletb.2012.08.020.
- [6] ATLAS Collaboration, Measurements of Higgs boson production and couplings in diboson final states with the ATLAS detector at the LHC, *Phys. Lett. B* 726 (2013) 88–119. arXiv:1307.1427, doi:10.1016/j.physletb.2013.08.010.
- [7] W. Beenakker, et al., Higgs radiation off top quarks at the Tevatron and the LHC, *Phys. Rev. Lett.* 87 (2001) 201805. arXiv:hep-ph/0107081, doi:10.1103/PhysRevLett.87.201805.
- [8] L. Reina, S. Dawson, D. Wackerroth, QCD corrections to associated $t\bar{t}h$ production at the Fermilab Tevatron, *Phys. Rev. D* 65 (2002) 053017. arXiv:hep-ph/0109066, doi:10.1103/PhysRevD.65.053017.
- [9] S. Dawson, C. Jackson, L. Orr, L. Reina, D. Wackerroth, Associated Higgs production with top quarks at the large hadron collider: NLO QCD corrections, *Phys. Rev. D* 68 (2003) 034022. arXiv:hep-ph/0305087, doi:10.1103/PhysRevD.68.034022.
- [10] M. Garzelli, A. Kardos, C. Papadopoulos, Z. Trocsanyi, Standard Model Higgs boson production in association with a top anti-top pair at NLO with parton showering, *Europhys. Lett.* 96 (2011) 11001. arXiv:1108.0387, doi:10.1209/0295-5075/96/11001.
- [11] R. Frederix, et al., Scalar and pseudoscalar Higgs production in association with a top-antitop pair, *Phys. Lett. B* 701 (2011) 427–433. arXiv:1104.5613, doi:10.1016/j.physletb.2011.06.012.
- [12] F. Maltoni, K. Paul, T. Stelzer, S. Willenbrock, Associated production of Higgs and single top at hadron colliders, *Phys. Rev. D* 64 (2001) 094023. arXiv:hep-ph/0106293, doi:10.1103/PhysRevD.64.094023.
- [13] V. Barger, M. McCaskey, G. Shaughnessy, Single top and Higgs associated production at the LHC, *Phys. Rev. D* 81 (2010) 034020. arXiv:0911.1556, doi:10.1103/PhysRevD.81.034020.
- [14] M. Farina, C. Grojean, F. Maltoni, E. Salvioni, A. Thamm, Lifting degeneracies in Higgs couplings using single top production in association with a Higgs boson, *JHEP* 1305 (2013) 022. arXiv:1211.3736, doi:10.1007/JHEP05(2013)022.
- [15] S. Biswas, E. Gabrielli, B. Mele, Single top and Higgs associated production as a probe of the $Ht\bar{t}$ coupling sign at the LHC, *JHEP* 1301 (2013) 088. arXiv:1211.0499, doi:10.1007/JHEP01(2013)088.
- [16] P. Agrawal, S. Mitra, A. Shivaji, Effect of Anomalous Couplings on the Associated Production of a Single Top Quark and a Higgs Boson at the LHC, *JHEP* 1312 (2013) 077. arXiv:1211.4362, doi:10.1007/JHEP12(2013)077.
- [17] R. Frederix, E. Re, P. Torrielli, Single-top t-channel hadroproduction in the four-flavour scheme with POWHEG and aMC@NLO, *JHEP* 1209 (2012) 130. arXiv:1207.5391, doi:10.1007/JHEP09(2012)130.
- [18] ATLAS Collaboration, ATLAS Experiment at the CERN Large Hadron Collider, *JINST* 3 (2008) S08003.
- [19] CMS Collaboration, Search for the associated production of the Higgs boson with a top-quark pair, *JHEP* 1409 (2014) 087, Erratum-ibid. 1410 (2014) 106. arXiv:1408.1682, doi:10.1007/JHEP09(2014)087.
- [20] ATLAS Collaboration, Improved luminosity determination in pp collisions at $\sqrt{s} = 7$ TeV using the ATLAS detector at the LHC, *Eur. Phys. J. C* 73 (2013) 2518. arXiv:1302.4393, doi:10.1140/epjc/s10052-013-2518-3.
- [21] G. Bevilacqua, et al., HELAC-NLO, *Comput. Phys. Commun.* 184 (2013) 986–997. arXiv:1110.1499, doi:10.1016/j.cpc.2012.10.033.
- [22] P. Nason, A New method for combining NLO QCD with shower Monte Carlo algorithms, *JHEP* 0411 (2004) 040. arXiv:hep-ph/0409146, doi:10.1088/1126-6708/2004/11/040.
- [23] S. Frixione, P. Nason, C. Oleari, Matching NLO QCD computations with Parton Shower simulations: the POWHEG method, *JHEP* 0711 (2007) 070. arXiv:0709.2092, doi:10.1088/1126-6708/2007/11/070.
- [24] S. Alioli, P. Nason, C. Oleari, E. Re, A general framework for implementing NLO calculations in shower Monte Carlo programs: the POWHEG BOX, *JHEP* 1006 (2010) 043. arXiv:1002.2581, doi:10.1007/JHEP06(2010)043.
- [25] T. Sjöstrand, S. Mrenna, P. Skands, A brief introduction to PYTHIA 8.1, *Comput. Phys. Commun.* 178 (2008) 852–867.
- [26] H.-L. Lai, et al., New parton distributions for collider physics, *Phys. Rev. D* 82 (2010) 074024. arXiv:1007.2241, doi:10.1103/PhysRevD.82.074024.
- [27] ATLAS Collaboration, New ATLAS event generator tunes to 2010 data, Tech. Rep. ATL-PHYS-PUB-2011-008 (April 2011). URL <https://cds.cern.ch/record/1345343>
- [28] ATLAS Collaboration, ATLAS tunes of PYTHIA 6 and Pythia 8 for MC11, Tech. Rep. ATL-PHYS-PUB-2011-009 (July 2011). URL <https://cds.cern.ch/record/1363300>
- [29] F. Maltoni, T. Stelzer, MadEvent: Automatic event generation with MadGraph, *JHEP* 0302 (2003) 027. arXiv:hep-ph/0208156.
- [30] J. Alwall, R. Frederix, S. Frixione, V. Hirschi, F. Maltoni, et al., The automated computation of tree-level and next-to-leading order differential cross sections, and their matching to parton shower simulations, *JHEP* 1407 (2014) 079. arXiv:1405.0301, doi:10.1007/JHEP07(2014)079.
- [31] M. Bähr, et al., Herwig++ Physics and Manual, *Eur. Phys. J. C* 58 (2008) 639–707. arXiv:0803.0883, doi:10.1140/epjc/s10052-008-0798-9.
- [32] T. Han, R. Ruiz, Higgs Bosons from Top Quark Decays, *Phys. Rev. D* 89 (2014) 074045. arXiv:1312.3324, doi:10.1103/PhysRevD.89.074045.
- [33] S. Alioli, P. Nason, C. Oleari, E. Re, NLO Higgs boson production via gluon fusion matched with shower in POWHEG, *JHEP* 0904 (2009) 002. arXiv:0812.0578, doi:10.1088/1126-6708/2009/04/002.
- [34] P. Nason, C. Oleari, NLO Higgs boson production via vector-boson fusion matched with shower in POWHEG, *JHEP* 1002 (2010) 037. arXiv:0911.5299, doi:10.1007/JHEP02(2010)037.
- [35] P. M. Nadolsky, et al., Implications of CTEQ global analysis for collider observables, *Phys. Rev. D* 78 (2008) 013004. arXiv:0802.0007, doi:10.1103/PhysRevD.78.013004.
- [36] GEANT4 Collaboration, S. Agostinelli et al., GEANT4: A simulation toolkit, *Nucl. Instrum. Meth. A* 506 (2003) 250.
- [37] ATLAS Collaboration, ATLAS Simulation Infrastructure, *Eur. Phys. J. C* 70 (2010) 823–874. arXiv:1005.4568, doi:10.1140/epjc/s10052-010-1429-9.
- [38] W. Beenakker, et al., NLO QCD corrections to $t\bar{t}h$ production in hadron collisions, *Nucl. Phys. B* 653 (2003) 151. arXiv:hep-ph/0211352, doi:10.1016/S0550-3213(03)00044-0.
- [39] S. Dawson, L. Orr, L. Reina, D. Wackerroth, Next-to-leading order QCD corrections to $pp \rightarrow t\bar{t}h$ at the CERN Large Hadron Collider, *Phys. Rev. D* 67 (2003) 071503. arXiv:hep-ph/0211438, doi:10.1103/PhysRevD.67.071503.
- [40] A. Djouadi, M. Spira, P. Zerwas, Production of Higgs bosons in proton colliders: QCD corrections, *Phys. Lett. B* 264 (1991) 440. doi:10.1016/0370-2693(91)90375-Z.
- [41] S. Dawson, Radiative corrections to Higgs boson production, *Nucl. Phys. B* 359 (1991) 283. doi:10.1016/0550-3213(91)90061-2.
- [42] M. Spira, A. Djouadi, D. Graudenz, P. Zerwas, Higgs boson production at the LHC, *Nucl. Phys. B* 453 (1995) 17. arXiv:hep-ph/9504378, doi:10.1016/0550-3213(95)00379-7.
- [43] R. V. Harlander, W. B. Kilgore, Next-to-next-to-leading order Higgs production at hadron colliders, *Phys. Rev. Lett.* 88 (2002) 201801. arXiv:hep-ph/0201206, doi:10.1103/PhysRevLett.88.201801.
- [44] C. Anastasiou, K. Melnikov, Higgs boson production at hadron colliders in NNLO QCD, *Nucl. Phys. B* 646 (2002) 220. arXiv:hep-ph/0207004, doi:10.1016/S0550-3213(02)00837-4.
- [45] V. Ravindran, J. Smith, W. L. van Neerven, NNLO corrections to the total cross-section for Higgs boson production in hadron-hadron collisions, *Nucl. Phys. B* 665 (2003) 325. arXiv:hep-ph/0302135, doi:10.1016/S0550-3213(03)00457-7.

- [46] S. Catani, D. de Florian, M. Grazzini, P. Nason, Soft gluon resummation for Higgs boson production at hadron colliders, JHEP 0307 (2003) 028. [arXiv:hep-ph/0306211](#).
- [47] U. Aglietti, R. Bonciani, G. Degrossi, A. Vicini, Two loop light fermion contribution to Higgs production and decays, Phys. Lett. B 595 (2004) 432. [arXiv:hep-ph/0404071](#), [doi:10.1016/j.physletb.2004.06.063](#).
- [48] S. Actis, G. Passarino, C. Sturm, S. Uccirati, NLO electroweak corrections to Higgs boson production at hadron colliders, Phys. Lett. B 670 (2008) 12. [arXiv:0809.1301](#), [doi:10.1016/j.physletb.2008.10.018](#).
- [49] M. Ciccolini, A. Denner, S. Dittmaier, Strong and electroweak corrections to the production of Higgs + 2-jets via weak interactions at the LHC, Phys. Rev. Lett. 99 (2007) 161803. [arXiv:0707.0381](#), [doi:10.1103/PhysRevLett.99.161803](#).
- [50] M. Ciccolini, A. Denner, S. Dittmaier, Electroweak and QCD corrections to Higgs production via vector-boson fusion at the LHC, Phys. Rev. D 77 (2008) 013002. [arXiv:0710.4749](#), [doi:10.1103/PhysRevD.77.013002](#).
- [51] K. Arnold, et al., VBFNLO: A Parton level Monte Carlo for processes with electroweak bosons, Comput. Phys. Commun. 180 (2009) 1661. [arXiv:0811.4559](#), [doi:10.1016/j.cpc.2009.03.006](#).
- [52] P. Bolzoni, F. Maltoni, S.-O. Moch, M. Zaro, Higgs production via vector-boson fusion at NNLO in QCD, Phys. Rev. Lett. 105 (2010) 011801. [arXiv:1003.4451](#), [doi:10.1103/PhysRevLett.105.011801](#).
- [53] T. Han, S. Willenbrock, QCD correction to the $pp \rightarrow WH$ and ZH total cross-sections, Phys. Lett. B 273 (1991) 167. [doi:10.1016/0370-2693\(91\)90572-8](#).
- [54] O. Brein, A. Djouadi, R. Harlander, NNLO QCD corrections to the Higgs-strahlung processes at hadron colliders, Phys. Lett. B 579 (2004) 149. [arXiv:hep-ph/0307206](#), [doi:10.1016/j.physletb.2003.10.112](#).
- [55] M. Ciccolini, S. Dittmaier, M. Krämer, Electroweak radiative corrections to associated WH and ZH production at hadron colliders, Phys. Rev. D 68 (2003) 073003. [arXiv:hep-ph/0306234](#), [doi:10.1103/PhysRevD.68.073003](#).
- [56] M. Botje, et al., The PDF4LHC working group interim recommendations [arXiv:1101.0538](#).
- [57] A. Martin, W. Stirling, R. Thorne, G. Watt, Parton distributions for the LHC, Eur. Phys. J. C 63 (2009) 189. [arXiv:0901.0002](#), [doi:10.1140/epjc/s10052-009-1072-5](#).
- [58] R. D. Ball, et al., Impact of heavy quark masses on parton distributions and LHC phenomenology, Nucl. Phys. B 849 (2011) 296. [arXiv:1101.1300](#), [doi:10.1016/j.nuclphysb.2011.03.021](#).
- [59] A. Djouadi, J. Kalinowski, M. Spira, HDECAY: A Program for Higgs boson decays in the Standard Model and its supersymmetric extension, Comput. Phys. Commun. 108 (1998) 56. [arXiv:hep-ph/9704448](#), [doi:10.1016/S0010-4655\(97\)00123-9](#).
- [60] A. Bredenstein, A. Denner, S. Dittmaier, M. Weber, Precise predictions for the Higgs-boson decay $H \rightarrow WW/ZZ \rightarrow 4$ leptons, Phys. Rev. D 74 (2006) 013004. [arXiv:hep-ph/0604011](#), [doi:10.1103/PhysRevD.74.013004](#).
- [61] S. Actis, G. Passarino, C. Sturm, S. Uccirati, NNLO computational techniques: The cases $H \rightarrow \gamma\gamma$ and $H \rightarrow gg$, Nucl. Phys. B 811 (2009) 182. [arXiv:0809.3667](#), [doi:10.1016/j.nuclphysb.2008.11.024](#).
- [62] A. Denner, S. Heinemeyer, I. Puljak, D. Rebuzzi, M. Spira, Standard Model Higgs-boson branching ratios with uncertainties, Eur. Phys. J. C 71 (2011) 1753. [arXiv:1107.5909](#), [doi:10.1140/epjc/s10052-011-1753-8](#).
- [63] LHC Higgs Cross Section Working Group, S. Dittmaier, C. Mariotti, G. Passarino, R. Tanaka (Eds.), Handbook of LHC Higgs Cross Sections: 1. Inclusive Observables, CERN-2011-002 [arXiv:1101.0593](#).
- [64] LHC Higgs Cross Section Working Group, S. Dittmaier, C. Mariotti, G. Passarino, R. Tanaka (Eds.), Handbook of LHC Higgs Cross Sections: 2. Differential Distributions, CERN-2012-002 [arXiv:1201.3084](#).
- [65] ATLAS Collaboration, Expected photon performance in the ATLAS experiment, Tech. Rep. ATLAS-PHYS-PUB-2011-007 (April 2011). URL <https://cds.cern.ch/record/1345329>
- [66] M. Cacciari, G. P. Salam, S. Sapeta, On the characterisation of the underlying event, JHEP 1004 (2010) 065. [arXiv:0912.4926](#), [doi:10.1007/JHEP04\(2010\)065](#).
- [67] ATLAS Collaboration, Measurement of the inclusive isolated prompt photon cross section in pp collisions at $\sqrt{s} = 7$ TeV with the ATLAS detector, Phys. Rev. D 83 (2011) 052005. [arXiv:1012.4389](#), [doi:10.1103/PhysRevD.83.052005](#).
- [68] ATLAS Collaboration, Measurement of the Higgs boson mass from the $H \rightarrow \gamma\gamma$ and $H \rightarrow ZZ^* \rightarrow 4\ell$ channels with the ATLAS detector using 25 fb^{-1} of pp collision data, Phys. Rev. D 90 (2014) 052004. [arXiv:1406.3827](#), [doi:10.1103/PhysRevD.90.052004](#).
- [69] ATLAS Collaboration, Electron reconstruction and identification efficiency measurements with the ATLAS detector using the 2011 LHC proton-proton collision data, Eur. Phys. J. C 74 (2014) 2941. [arXiv:1404.2240](#), [doi:10.1140/epjc/s10052-014-2941-0](#).
- [70] ATLAS Collaboration, Muon reconstruction efficiency and momentum resolution of the ATLAS experiment in proton-proton collisions at $\sqrt{s} = 7$ TeV in 2010, Eur. Phys. J. C 74 (9) (2014) 3034. [arXiv:1404.4562](#), [doi:10.1140/epjc/s10052-014-3034-9](#).
- [71] M. Cacciari, G. P. Salam, G. Soyez, The Anti-k(t) jet clustering algorithm, JHEP 0804 (2008) 063. [arXiv:0802.1189](#), [doi:10.1088/1126-6708/2008/04/063](#).
- [72] ATLAS Collaboration, Jet energy measurement and its systematic uncertainty in proton-proton collisions at $\sqrt{s} = 7$ TeV with the ATLAS detector, accepted by Eur. Phys. J. C. [arXiv:1406.0076](#).
- [73] M. Cacciari, G. P. Salam, Pileup subtraction using jet areas, Phys. Lett. B 659 (2008) 119. [doi:10.1016/j.physletb.2007.09.077](#).
- [74] ATLAS Collaboration, Commissioning of the ATLAS high-performance b-tagging algorithms in the 7 TeV collision data, Tech. Rep. ATLAS-CONF-2011-102 (July 2011). URL <https://cdsweb.cern.ch/record/1369219>
- [75] ATLAS Collaboration, Calibration of the performance of b-tagging for c and light-flavour jets in the 2012 ATLAS data, Tech. Rep. ATLAS-CONF-2014-046 (July 2014). URL <https://cdsweb.cern.ch/record/1741020>
- [76] ATLAS Collaboration, Performance of missing transverse momentum reconstruction in ATLAS with 2011 proton-proton collisions at $\sqrt{s} = 7$ TeV, Tech. Rep. ATLAS-CONF-2012-101 (July 2012). URL <https://cdsweb.cern.ch/record/1463915>
- [77] M. Oreglia, Charmonium spectroscopy from radiative decays of the J/ψ and ψ' , Ph.D. thesis (1980).
- [78] ATLAS Collaboration, Measurement of Higgs boson production in the diphoton decay channel in pp collisions at center-of-mass energies of 7 and 8 TeV with the ATLAS detector, accepted by Phys. Rev. D. [arXiv:1408.7084](#).
- [79] ATLAS Collaboration, Performance of the ATLAS Trigger System in 2010, Eur. Phys. J. C 72 (2012) 1849. [arXiv:1110.1530](#), [doi:10.1140/epjc/s10052-011-1849-1](#).
- [80] ATLAS Collaboration, Electron and photon energy calibration with the ATLAS detector using LHC Run 1 data, Eur. Phys. J. C 74 (10) (2014) 3071. [arXiv:1407.5063](#), [doi:10.1140/epjc/s10052-014-3071-4](#).
- [81] ATLAS Collaboration, Search for top quark decays $t \rightarrow qH$ with $H \rightarrow \gamma\gamma$ using the ATLAS detector, JHEP 1406 (2014) 008. [arXiv:1403.6293](#), [doi:10.1007/JHEP06\(2014\)008](#).
- [82] LHC Higgs Cross Section Working Group, S. Heinemeyer, C. Mariotti, G. Passarino, R. Tanaka (Eds.), Handbook of LHC Higgs Cross Sections: 3. Higgs Properties, CERN-2013-004 [arXiv:1307.1347](#).
- [83] ATLAS Collaboration, A study of heavy flavor quarks produced in association with top quark pairs at $\sqrt{s} = 7$ TeV using the ATLAS detector, Phys. Rev. D 89 (2014) 072012. [arXiv:1304.6386](#), [doi:10.1103/PhysRevD.89.072012](#).
- [84] ATLAS Collaboration, Measurement of the cross-section for W boson production in association with b-jets in pp collisions at $\sqrt{s} = 7$ TeV with the ATLAS detector, JHEP 1306 (2013) 084. [arXiv:1302.2929](#), [doi:10.1007/JHEP06\(2013\)084](#).
- [85] A. L. Read, Presentation of search results: The CL_s technique, J. Phys. G28 (2002) 2963–2704.
- [86] G. Cowan, K. Cranmer, E. Gross, O. Vitells, Asymptotic formulae for likelihood-based tests of new physics, Eur. Phys. J. C 71 (2011) 1554. [arXiv:1007.1727](#).

The ATLAS Collaboration

G. Aad⁸⁴, B. Abbott¹¹², J. Abdallah¹⁵², S. Abdel Khalek¹¹⁶, O. Abdinov¹¹, R. Aben¹⁰⁶, B. Abi¹¹³, M. Abolins⁸⁹, O.S. AbouZeid¹⁵⁹, H. Abramowicz¹⁵⁴, H. Abreu¹⁵³, R. Abreu³⁰, Y. Abulaiti^{147a,147b}, B.S. Acharya^{165a,165b,a}, L. Adamczyk^{38a}, D.L. Adams²⁵, J. Adelman¹⁷⁷, S. Adomeit⁹⁹, T. Adye¹³⁰, T. Agatonovic-Jovin^{13a}, J.A. Aguilar-Saavedra^{125a,125f}, M. Agustoni¹⁷, S.P. Ahlen²², F. Ahmadov^{64,b}, G. Aielli^{134a,134b}, H. Akerstedt^{147a,147b}, T.P.A. Åkesson⁸⁰, G. Akimoto¹⁵⁶, A.V. Akimov⁹⁵, G.L. Alberghi^{20a,20b}, J. Albert¹⁷⁰, S. Albrand⁵⁵, M.J. Alconada Verzini⁷⁰, M. Aleksa³⁰, I.N. Aleksandrov⁶⁴, C. Alexa^{26a}, G. Alexander¹⁵⁴, G. Alexandre⁴⁹, T. Alexopoulos¹⁰, M. Alhroob^{165a,165c}, G. Alimonti^{90a}, L. Alio⁸⁴, J. Alison³¹, B.M.M. Allbrooke¹⁸, L.J. Allison⁷¹, P.P. Allport⁷³, A. Aloisio^{103a,103b}, A. Alonso³⁶, F. Alonso⁷⁰, C. Alpigiani⁷⁵, A. Altheimer³⁵, B. Alvarez Gonzalez⁸⁹, M.G. Alviggi^{103a,103b}, K. Amako⁶⁵, Y. Amaral Coutinho^{24a}, C. Amelung²³, D. Amidei⁸⁸, S.P. Amor Dos Santos^{125a,125c}, A. Amorim^{125a,125b}, S. Amoroso⁴⁸, N. Amram¹⁵⁴, G. Amundsen²³, C. Anastopoulos¹⁴⁰, L.S. Ancu⁴⁹, N. Andari³⁰, T. Andeen³⁵, C.F. Anders^{58b}, G. Anders³⁰, K.J. Anderson³¹, A. Andreazza^{90a,90b}, V. Andrei^{58a}, X.S. Anduaga⁷⁰, S. Angelidakis⁹, I. Angelozzi¹⁰⁶, P. Anger⁴⁴, A. Angerami³⁵, F. Anghinolfi³⁰, A.V. Anisenkov^{108,c}, N. Anjos¹², A. Annovi⁴⁷, A. Antonaki⁹, M. Antonelli⁴⁷, A. Antonov⁹⁷, J. Antos^{145b}, F. Anulli^{133a}, M. Aoki⁶⁵, L. Aperio Bella¹⁸, R. Apolle^{119,d}, G. Arabidze⁸⁹, I. Aracena¹⁴⁴, Y. Arai⁶⁵, J.P. Araque^{125a}, A.T.H. Arce⁴⁵, J-F. Arguin⁹⁴, S. Argyropoulos⁴², M. Arik^{19a}, A.J. Armbruster³⁰, O. Arnaez³⁰, V. Arnal⁸¹, H. Arnold⁴⁸, M. Arratia²⁸, O. Arslan²¹, A. Artamonov⁹⁶, G. Artoni²³, S. Asai¹⁵⁶, N. Asbah⁴², A. Ashkenazi¹⁵⁴, B. Åsman^{147a,147b}, L. Asquith⁶, K. Assamagan²⁵, R. Astalos^{145a}, M. Atkinson¹⁶⁶, N.B. Atlay¹⁴², B. Auerbach⁶, K. Augsten¹²⁷, M. Auresseau^{146b}, G. Avolio³⁰, G. Azuelos^{94,e}, Y. Azuma¹⁵⁶, M.A. Baak³⁰, A.E. Baas^{58a}, C. Bacci^{135a,135b}, H. Bachacou¹³⁷, K. Bachas¹⁵⁵, M. Backes³⁰, M. Backhaus³⁰, J. Backus Mayes¹⁴⁴, E. Badescu^{26a}, P. Bagiacchi^{133a,133b}, P. Bagnaia^{133a,133b}, Y. Bai^{33a}, T. Bain³⁵, J.T. Baines¹³⁰, O.K. Baker¹⁷⁷, P. Balek¹²⁸, F. Balli¹³⁷, E. Banas³⁹, Sw. Banerjee¹⁷⁴, A.A.E. Bannoura¹⁷⁶, V. Bansal¹⁷⁰, H.S. Bansil¹⁸, L. Barak¹⁷³, S.P. Baranov⁹⁵, E.L. Barberio⁸⁷, D. Barberis^{50a,50b}, M. Barbero⁸⁴, T. Barillari¹⁰⁰, M. Barisonzi¹⁷⁶, T. Barklow¹⁴⁴, N. Barlow²⁸, B.M. Barnett¹³⁰, R.M. Barnett¹⁵, Z. Barnovska⁵, A. Baroncelli^{135a}, G. Barone⁴⁹, A.J. Barr¹¹⁹, F. Barreiro⁸¹, J. Barreiro Guimarães da Costa⁵⁷, R. Bartoldus¹⁴⁴, A.E. Barton⁷¹, P. Bartos^{145a}, V. Bartsch¹⁵⁰, A. Bassalat¹¹⁶, A. Basye¹⁶⁶, R.L. Bates⁵³, J.R. Batley²⁸, M. Battaglia¹³⁸, M. Battistin³⁰, F. Bauer¹³⁷, H.S. Bawa^{144,f}, M.D. Beattie⁷¹, T. Beau⁷⁹, P.H. Beauchemin¹⁶², R. Beccherle^{123a,123b}, P. Bechtel²¹, H.P. Beck¹⁷, K. Becker¹⁷⁶, S. Becker⁹⁹, M. Beckingham¹⁷¹, C. Becot¹¹⁶, A.J. Beddall^{19c}, A. Beddall^{19c}, S. Bedikian¹⁷⁷, V.A. Bednyakov⁶⁴, C.P. Bee¹⁴⁹, L.J. Beamster¹⁰⁶, T.A. Beermann¹⁷⁶, M. Begel²⁵, K. Behr¹¹⁹, C. Belanger-Champagne⁸⁶, P.J. Bell⁴⁹, W.H. Bell⁴⁹, G. Bella¹⁵⁴, L. Bellagamba^{20a}, A. Bellerive²⁹, M. Bellomo⁸⁵, K. Belotskiy⁹⁷, O. Beltramello³⁰, O. Benary¹⁵⁴, D. Benchekroun^{136a}, K. Bendtz^{147a,147b}, N. Benekos¹⁶⁶, Y. Benhammou¹⁵⁴, E. Benhar Noccioli⁴⁹, J.A. Benitez Garcia^{160b}, D.P. Benjamin⁴⁵, J.R. Bensinger²³, K. Benslama¹³¹, S. Bentvelsen¹⁰⁶, D. Berge¹⁰⁶, E. Bergeas Kuutmann¹⁶, N. Berger⁵, F. Berghaus¹⁷⁰, J. Beringer¹⁵, C. Bernard²², P. Bernat⁷⁷, C. Bernius⁷⁸, F.U. Bernlochner¹⁷⁰, T. Berry⁷⁶, P. Berta¹²⁸, C. Bertella⁸⁴, G. Bertoli^{147a,147b}, F. Bertolucci^{123a,123b}, C. Bertsche¹¹², D. Bertsche¹¹², M.I. Besana^{90a}, G.J. Besjes¹⁰⁵, O. Bessidskaia^{147a,147b}, M. Bessner⁴², N. Besson¹³⁷, C. Betancourt⁴⁸, S. Bethke¹⁰⁰, W. Bhimji⁴⁶, R.M. Bianchi¹²⁴, L. Bianchini²³, M. Bianco³⁰, O. Biebel⁹⁹, S.P. Bieniek⁷⁷, K. Bierwagen⁵⁴, J. Biesiada¹⁵, M. Biglietti^{135a}, J. Bilbao De Mendizabal⁴⁹, H. Bilokon⁴⁷, M. Bindi⁵⁴, S. Binet¹¹⁶, A. Bingul^{19c}, C. Bini^{133a,133b}, C.W. Black¹⁵¹, J.E. Black¹⁴⁴, K.M. Black²², D. Blackburn¹³⁹, R.E. Blair⁶, J.-B. Blanchard¹³⁷, T. Blazek^{145a}, I. Bloch⁴², C. Blocker²³, W. Blum^{82,*}, U. Blumenschein⁵⁴, G.J. Bobbink¹⁰⁶, V.S. Bobrovnikov^{108,c}, S.S. Bocchetta⁸⁰, A. Bocci⁴⁵, C. Bock⁹⁹, C.R. Boddy¹¹⁹, M. Boehler⁴⁸, T.T. Boek¹⁷⁶, J.A. Bogaerts³⁰, A.G. Bogdanchikov¹⁰⁸, A. Bogouch^{91,*}, C. Bohm^{147a}, J. Bohm¹²⁶, V. Boisvert⁷⁶, T. Bold^{38a}, V. Boldea^{26a}, A.S. Boldyrev⁹⁸, M. Bomben⁷⁹, M. Bona⁷⁵, M. Boonekamp¹³⁷, A. Borisov¹²⁹, G. Borissov⁷¹, M. Borri⁸³, S. Borroni⁴², J. Bortfeldt⁹⁹, V. Bortolotto^{135a,135b}, K. Bos¹⁰⁶, D. Boscherini^{20a}, M. Bosman¹², H. Boterenbrood¹⁰⁶, J. Boudreau¹²⁴, J. Bouffard², E.V. Bouhova-Thacker⁷¹, D. Boumediene³⁴, C. Bourdarios¹¹⁶, N. Bousson¹¹³, S. Boutouil^{136d}, A. Boveia³¹, J. Boyd³⁰, I.R. Boyko⁶⁴, I. Bozic^{13a}, J. Bracinik¹⁸, A. Brandt⁸, G. Brandt¹⁵, O. Brandt^{58a}, U. Bratzler¹⁵⁷, B. Brau⁸⁵, J.E. Brau¹¹⁵, H.M. Braun^{176,*}, S.F. Brazzale^{165a,165c}, B. Brelier¹⁵⁹, K. Brendlinger¹²¹, A.J. Brennan⁸⁷, R. Brenner¹⁶⁷, S. Bressler¹⁷³, K. Bristow^{146c}, T.M. Bristow⁴⁶, D. Britton⁵³, F.M. Brochu²⁸, I. Brock²¹, R. Brock⁸⁹, C. Bromberg⁸⁹, J. Bronner¹⁰⁰, G. Brooijmans³⁵, T. Brooks⁷⁶, W.K. Brooks^{32b}, J. Brosamer¹⁵, E. Brost¹¹⁵, J. Brown⁵⁵, P.A. Bruckman de Renstrom³⁹, D. Bruncko^{145b}, R. Bruneliere⁴⁸, S. Brunet⁶⁰, A. Bruni^{20a}, G. Bruni^{20a}, M. Bruschi^{20a}, L. Bryngemark⁸⁰, T. Buanes¹⁴, Q. Buat¹⁴³, F. Bucci⁴⁹, P. Buchholz¹⁴², R.M. Buckingham¹¹⁹, A.G. Buckley⁵³, S.I. Buda^{26a}, I.A. Budagov⁶⁴, F. Buehrer⁴⁸, L. Bugge¹¹⁸, M.K. Bugge¹¹⁸, O. Bulekov⁹⁷, A.C. Bundock⁷³, H. Burckhart³⁰, S. Burdin⁷³, B. Burghgrave¹⁰⁷, S. Burke¹³⁰, I. Burmeister⁴³, E. Busato³⁴, D. Büscher⁴⁸, V. Büscher⁸², P. Bussey⁵³, C.P. Buszello¹⁶⁷, B. Butler⁵⁷, J.M. Butler²², A.I. Butt³, C.M. Buttar⁵³, J.M. Butterworth⁷⁷, P. Butti¹⁰⁶, W. Buttinger²⁸, A. Buzatu⁵³, M. Byszewski¹⁰, S. Cabrera Urbán¹⁶⁸, D. Caforio^{20a,20b}, O. Cakir^{4a}, P. Calafiura¹⁵, A. Calandri¹³⁷, G. Calderini⁷⁹, P. Calfayan⁹⁹, R. Calkins¹⁰⁷, L.P. Caloba^{24a}, D. Calvet³⁴, S. Calvet³⁴, R. Camacho Toro⁴⁹, S. Camarda⁴², D. Cameron¹¹⁸, L.M. Caminada¹⁵, R. Caminal Armadans¹², S. Campana³⁰, M. Campanelli⁷⁷, A. Campoverde¹⁴⁹, V. Canale^{103a,103b}, A. Canepa^{160a}, M. Cano Bret⁷⁵, J. Cantero⁸¹, R. Cantrill^{125a}, T. Cao⁴⁰, M.D.M. Capeans Garrido³⁰, I. Caprini^{26a}, M. Caprini^{26a}, M. Capua^{37a,37b}, R. Caputo⁸², R. Cardarelli^{134a}, T. Carli³⁰, G. Carlino^{103a}, L. Carminati^{90a,90b}, S. Caron¹⁰⁵, E. Carquin^{32a}, G.D. Carrillo-Montoya^{146c}, J.R. Carter²⁸, J. Carvalho^{125a,125c}, D. Casadei⁷⁷, M.P. Casado¹², M. Casolino¹², E. Castaneda-Miranda^{146b}, A. Castelli¹⁰⁶, V. Castillo Gimenez¹⁶⁸, N.F. Castro^{125a}, P. Catastini⁵⁷, A. Catinaccio³⁰, J.R. Catmore¹¹⁸, A. Cattai³⁰, G. Cattani^{134a,134b}, V. Cavaliere¹⁶⁶, D. Cavalli^{90a}, M. Cavalli-Sforza¹², V. Cavasinni^{123a,123b}, F. Ceradini^{135a,135b}, B.C. Cerio⁴⁵, K. Cerny¹²⁸,

A.S. Cerqueira^{24b}, A. Cerri¹⁵⁰, L. Cerrito⁷⁵, F. Cerutti¹⁵, M. Cerv³⁰, A. Cervelli¹⁷, S.A. Cetin^{19b}, A. Chafaq^{136a}, D. Chakraborty¹⁰⁷, I. Chalupkova¹²⁸, P. Chang¹⁶⁶, B. Chapleau⁸⁶, J.D. Chapman²⁸, D. Charfeddine¹¹⁶, D.G. Charlton¹⁸, C.C. Chau¹⁵⁹, C.A. Chavez Barajas¹⁵⁰, S. Cheatham⁸⁶, A. Chegwidden⁸⁹, S. Chekanov⁶, S.V. Chekulaev^{160a}, G.A. Chelkov^{64.g}, M.A. Chelstowska⁸⁸, C. Chen⁶³, H. Chen²⁵, K. Chen¹⁴⁹, L. Chen^{33d,h}, S. Chen^{33c}, X. Chen^{146c}, Y. Chen⁶⁶, Y. Chen³⁵, H.C. Cheng⁸⁸, Y. Cheng³¹, A. Cheplakov⁶⁴, R. Cherkaoui El Moursli^{136e}, V. Chernyatin^{25,*}, E. Cheu⁷, L. Chevalier¹³⁷, V. Chiarella⁴⁷, G. Chiefari^{103a,103b}, J.T. Childers⁶, A. Chilingarov⁷¹, G. Chiodini^{72a}, A.S. Chisholm¹⁸, R.T. Chislett⁷⁷, A. Chitan^{26a}, M.V. Chizhov⁶⁴, S. Chouridou⁹, B.K.B. Chow⁹⁹, D. Chromek-Burckhart³⁰, M.L. Chu¹⁵², J. Chudoba¹²⁶, J.J. Chwastowski³⁹, L. Chytka¹¹⁴, G. Ciapetti^{133a,133b}, A.K. Ciftci^{4a}, R. Ciftci^{4a}, D. Cinca⁵³, V. Cindro⁷⁴, A. Cicio¹⁵, P. Cirkovic^{13b}, Z.H. Citron¹⁷³, M. Citterio^{90a}, M. Ciubancan^{26a}, A. Clark⁴⁹, P.J. Clark⁴⁶, R.N. Clarke¹⁵, W. Cleland¹²⁴, J.C. Clemens⁸⁴, C. Clement^{147a,147b}, Y. Coadou⁸⁴, M. Cobal^{165a,165c}, A. Coccaro¹³⁹, J. Cochran⁶³, L. Coffey²³, J.G. Cogan¹⁴⁴, J. Coggeshall¹⁶⁶, B. Cole³⁵, S. Cole¹⁰⁷, A.P. Colijn¹⁰⁶, J. Collot⁵⁵, T. Colombo^{58c}, G. Colon⁸⁵, G. Compostella¹⁰⁰, P. Conde Muño^{125a,125b}, E. Coniavitis⁴⁸, M.C. Conidi¹², S.H. Connell^{146b}, I.A. Connelly⁷⁶, S.M. Consonni^{90a,90b}, V. Consorti⁴⁸, S. Constantinescu^{26a}, C. Conta^{120a,120b}, G. Conti⁵⁷, F. Conventi^{103a,i}, M. Cooke¹⁵, B.D. Cooper⁷⁷, A.M. Cooper-Sarkar¹¹⁹, N.J. Cooper-Smith⁷⁶, K. Copic¹⁵, T. Cornelissen¹⁷⁶, M. Corradi^{20a}, F. Corriveau^{86,j}, A. Corso-Radu¹⁶⁴, A. Cortes-Gonzalez¹², G. Cortiana¹⁰⁰, G. Costa^{90a}, M.J. Costa¹⁶⁸, D. Costanzo¹⁴⁰, D. Côte⁸, G. Cottin²⁸, G. Cowan⁷⁶, B.E. Cox⁸³, K. Cranmer¹⁰⁹, G. Cree²⁹, S. Crépe-Renaudin⁵⁵, F. Crescioli⁷⁹, W.A. Cribbs^{147a,147b}, M. Crispin Ortuzar¹¹⁹, M. Cristinziani²¹, V. Croft¹⁰⁵, G. Crosetti^{37a,37b}, C.-M. Cuciuc^{26a}, T. Cuhadar Donszelmann¹⁴⁰, J. Cummings¹⁷⁷, M. Curatolo⁴⁷, C. Cuthbert¹⁵¹, H. Czirr¹⁴², P. Czodrowski³, Z. Czyczula¹⁷⁷, S. D'Auria⁵³, M. D'Onofrio⁷³, M.J. Da Cunha Sargedas De Sousa^{125a,125b}, C. Da Via⁸³, W. Dabrowski^{38a}, A. Dafinca¹¹⁹, T. Dai⁸⁸, O. Dale¹⁴, F. Dallaire⁹⁴, C. Dallapiccola⁸⁵, M. Dam³⁶, A.C. Daniells¹⁸, M. Dano Hoffmann¹³⁷, V. Dao⁴⁸, G. Darbo^{50a}, S. Darmora⁸, J.A. Dassoulas⁴², A. Dattagupta⁶⁰, W. Davey²¹, C. David¹⁷⁰, T. Davidek¹²⁸, E. Davies^{119,d}, M. Davies¹⁵⁴, O. Davignon⁷⁹, A.R. Davison⁷⁷, P. Davison⁷⁷, Y. Davygora^{58a}, E. Dawe¹⁴³, I. Dawson¹⁴⁰, R.K. Daya-Ishmukhametova⁸⁵, K. De⁸, R. de Asmundis^{103a}, S. De Castro^{20a,20b}, S. De Cecco⁷⁹, N. De Groot¹⁰⁵, P. de Jong¹⁰⁶, H. De la Torre⁸¹, F. De Lorenzi⁶³, L. De Nooij¹⁰⁶, D. De Pedis^{133a}, A. De Salvo^{133a}, U. De Sanctis¹⁵⁰, A. De Santo¹⁵⁰, J.B. De Vivie De Regie¹¹⁶, W.J. Dearnaley⁷¹, R. Debbe²⁵, C. Debenedetti¹³⁸, B. Dechenaux⁵⁵, D.V. Dedovich⁶⁴, I. Deigaard¹⁰⁶, J. Del Peso⁸¹, T. Del Prete^{123a,123b}, F. Deliot¹³⁷, C.M. Delitzsch⁴⁹, M. Deliyergiyev⁷⁴, A. Dell'Acqua³⁰, L. Dell'Asta²², M. Dell'Orso^{123a,123b}, M. Della Pietra^{103a,i}, D. della Volpe⁴⁹, M. Delmastro⁵, P.A. Delsart⁵⁵, C. Deluca¹⁰⁶, S. Demers¹⁷⁷, M. Demichev⁶⁴, A. Demilly⁷⁹, S.P. Denisov¹²⁹, D. Derendarz³⁹, J.E. Derkaoui^{136d}, F. Derue⁷⁹, P. Dervan⁷³, K. Desch²¹, C. Deterre⁴², P.O. Deviveiros¹⁰⁶, A. Dewhurst¹³⁰, S. Dhaliwal¹⁰⁶, A. Di Ciaccio^{134a,134b}, L. Di Ciaccio⁵, A. Di Domenico^{133a,133b}, C. Di Donato^{103a,103b}, A. Di Girolamo³⁰, B. Di Girolamo³⁰, A. Di Mattia¹⁵³, B. Di Micco^{135a,135b}, R. Di Nardo⁴⁷, A. Di Simone⁴⁸, R. Di Sipio^{20a,20b}, D. Di Valentino²⁹, F.A. Dias⁴⁶, M.A. Diaz^{32a}, E.B. Diehl⁸⁸, J. Dietrich⁴², T.A. Dietzsch^{58a}, S. Diglio⁸⁴, A. Dimitrievska^{13a}, J. Dingfelder²¹, C. Dionisi^{133a,133b}, P. Dita^{26a}, S. Dita^{26a}, F. Dittus³⁰, F. Djama⁸⁴, T. Djobava^{51b}, M.A.B. do Vale^{24c}, A. Do Valle Wemans^{125a,125g}, D. Dobos³⁰, C. Doglioni⁴⁹, T. Doherty⁵³, T. Dohmae¹⁵⁶, J. Dolejsi¹²⁸, Z. Dolezal¹²⁸, B.A. Dolgoshein^{97,*}, M. Donadelli^{24d}, S. Donati^{123a,123b}, P. Dondero^{120a,120b}, J. Donini³⁴, J. Dopke¹³⁰, A. Doria^{103a}, M.T. Dova⁷⁰, A.T. Doyle⁵³, M. Dris¹⁰, J. Dubbert⁸⁸, S. Dube¹⁵, E. Dubreuil³⁴, E. Duchovni¹⁷³, G. Duckeck⁹⁹, O.A. Ducu^{26a}, D. Duda¹⁷⁶, A. Dudarev³⁰, F. Dudziak⁶³, L. Dufflot¹¹⁶, L. Duguid⁷⁶, M. Dührssen³⁰, M. Dunford^{58a}, H. Duran Yildiz^{4a}, M. Düren⁵², A. Durglishvili^{51b}, M. Dwuznik^{38a}, M. Dyndal^{38a}, J. Ebke⁹⁹, W. Edson², N.C. Edwards⁴⁶, W. Ehrenfeld²¹, T. Eifert¹⁴⁴, G. Eigen¹⁴, K. Einsweiler¹⁵, T. Ekelof¹⁶⁷, M. El Kacimi^{136c}, M. Ellert¹⁶⁷, S. Elles⁵, F. Ellinghaus⁸², N. Ellis³⁰, J. Elmsheuser⁹⁹, M. Elsing³⁰, D. Emeliyanov¹³⁰, Y. Enari¹⁵⁶, O.C. Endner⁸², M. Endo¹¹⁷, R. Engelmann¹⁴⁹, J. Erdmann¹⁷⁷, A. Ereditato¹⁷, D. Eriksson^{147a}, G. Ernis¹⁷⁶, J. Ernst², M. Ernst²⁵, J. Ernwein¹³⁷, D. Errede¹⁶⁶, S. Errede¹⁶⁶, E. Ertel⁸², M. Escalier¹¹⁶, H. Esch⁴³, C. Escobar¹²⁴, B. Esposito⁴⁷, A.I. Etienvre¹³⁷, E. Etzion¹⁵⁴, H. Evans⁶⁰, A. Ezhilov¹²², L. Fabbri^{20a,20b}, G. Facini³¹, R.M. Fakhruddinov¹²⁹, S. Falciano^{133a}, R.J. Falla⁷⁷, J. Faltova¹²⁸, Y. Fang^{33a}, M. Fanti^{90a,90b}, A. Farbin⁸, A. Farilla^{135a}, T. Farooque¹², S. Farrell¹⁵, S.M. Farrington¹⁷¹, P. Farthouat³⁰, F. Fassi^{136e}, P. Fassnacht³⁰, D. Fassouliotis⁹, A. Favareto^{50a,50b}, L. Fayard¹¹⁶, P. Federic^{145a}, O.L. Fedin^{122,k}, W. Fedorko¹⁶⁹, M. Fehling-Kaschek⁴⁸, S. Feigl³⁰, L. Felgioni⁸⁴, C. Feng^{33d}, E.J. Feng⁶, H. Feng⁸⁸, A.B. Fenyuk¹²⁹, S. Fernandez Perez³⁰, S. Ferrag⁵³, J. Ferrando⁵³, A. Ferrari¹⁶⁷, P. Ferrari¹⁰⁶, R. Ferrari^{120a}, D.E. Ferreira de Lima⁵³, A. Ferrer¹⁶⁸, D. Ferrere⁴⁹, C. Ferretti⁸⁸, A. Ferretto Parodi^{50a,50b}, M. Fiascaris³¹, F. Fiedler⁸², A. Filipčić⁷⁴, M. Filipuzzi⁴², F. Filthaut¹⁰⁵, M. Fincke-Keeler¹⁷⁰, K.D. Finelli¹⁵¹, M.C.N. Fiolhais^{125a,125c}, L. Fiorini¹⁶⁸, A. Firan⁴⁰, A. Fischer², J. Fischer¹⁷⁶, W.C. Fisher⁸⁹, E.A. Fitzgerald²³, M. Flechl⁴⁸, I. Fleck¹⁴², P. Fleischmann⁸⁸, S. Fleischmann¹⁷⁶, G.T. Fletcher¹⁴⁰, G. Fletcher⁷⁵, T. Flick¹⁷⁶, A. Floderus⁸⁰, L.R. Flores Castillo^{174,i}, A.C. Florez Bustos^{160b}, M.J. Flowerdew¹⁰⁰, A. Formica¹³⁷, A. Forti⁸³, D. Fortin^{160a}, D. Fournier¹¹⁶, H. Fox⁷¹, S. Fracchia¹², P. Francavilla⁷⁹, M. Franchini^{20a,20b}, S. Franchino³⁰, D. Francis³⁰, L. Franconi¹¹⁸, M. Franklin⁵⁷, S. Franz⁶¹, M. Fraternali^{120a,120b}, S.T. French²⁸, C. Friedrich⁴², F. Friedrich⁴⁴, D. Froidevaux³⁰, J.A. Frost²⁸, C. Fukunaga¹⁵⁷, E. Fullana Torregrosa⁸², B.G. Fulson¹⁴⁴, J. Fuster¹⁶⁸, C. Gabaldon⁵⁵, O. Gabizon¹⁷³, A. Gabrielli^{20a,20b}, A. Gabrielli^{133a,133b}, S. Gadatsch¹⁰⁶, S. Gadomski⁴⁹, G. Gagliardi^{50a,50b}, P. Gagnon⁶⁰, C. Galea¹⁰⁵, B. Galhardo^{125a,125c}, E.J. Gallas¹¹⁹, V. Gallo¹⁷, B.J. Gallop¹³⁰, P. Gallus¹²⁷, G. Galster³⁶, K.K. Gan¹¹⁰, J. Gao^{33b,h}, Y.S. Gao^{144,f}, F.M. Garay Walls⁴⁶, F. Garbersson¹⁷⁷, C. García¹⁶⁸, J.E. García Navarro¹⁶⁸, M. Garcia-Sciveres¹⁵, R.W. Gardner³¹, N. Garelli¹⁴⁴, V. Garonne³⁰, C. Gatti⁴⁷, G. Gaudio^{120a}, B. Gaur¹⁴², L. Gauthier⁹⁴, P. Gauzzi^{133a,133b}, I.L. Gavrilenko⁹⁵, C. Gay¹⁶⁹, G. Gaycken²¹, E.N. Gazis¹⁰, P. Ge^{33d}, Z. Gece¹⁶⁹, C.N.P. Gee¹³⁰, D.A.A. Geerts¹⁰⁶, Ch. Geich-Gimbel²¹, K. Gellerstedt^{147a,147b}, C. Gemme^{50a}, A. Gemmell⁵³, M.H. Genest⁵⁵, S. Gentile^{133a,133b}, M. George⁵⁴, S. George⁷⁶, D. Gerbaudo¹⁶⁴, A. Gershon¹⁵⁴, H. Ghazlane^{136b}, N. Ghodbane³⁴, B. Giacobbe^{20a},

S. Giagu^{133a,133b}, V. Giangiobbe¹², P. Giannetti^{123a,123b}, F. Gianotti³⁰, B. Gibbard²⁵, S.M. Gibson⁷⁶, M. Gilchriese¹⁵, T.P.S. Gillam²⁸, D. Gillberg³⁰, G. Gilles³⁴, D.M. Gingrich^{3,e}, N. Giokaris⁹, M.P. Giordani^{165a,165c}, R. Giordano^{103a,103b}, F.M. Giorgi^{20a}, F.M. Giorgi¹⁶, P.F. Giraud¹³⁷, D. Giugni^{90a}, C. Giuliani⁴⁸, M. Giulini^{58b}, B.K. Gjelsten¹¹⁸, S. Gkaitatzis¹⁵⁵, I. Gkialas^{155,m}, L.K. Gladilin⁹⁸, C. Glasman⁸¹, J. Glatzer³⁰, P.C.F. Glaysheer⁴⁶, A. Glazov⁴², G.L. Glonti⁶⁴, M. Goblirsch-Kolb¹⁰⁰, J.R. Goddard⁷⁵, J. Godlewski³⁰, C. Goeringer⁸², S. Goldfarb⁸⁸, T. Golling¹⁷⁷, D. Golubkov¹²⁹, A. Gomes^{125a,125b,125d}, L.S. Gomez Fajardo⁴², R. Gonçalo^{125a}, J. Goncalves Pinto Firmino Da Costa¹³⁷, L. Gonella²¹, S. González de la Hoz¹⁶⁸, G. Gonzalez Parra¹², S. Gonzalez-Sevilla⁴⁹, L. Goossens³⁰, P.A. Gorbounov⁹⁶, H.A. Gordon²⁵, I. Gorelov¹⁰⁴, B. Gorini³⁰, E. Gorini^{72a,72b}, A. Gorišek⁷⁴, E. Gornicki³⁹, A.T. Goshaw⁶, C. Gössling⁴³, M.I. Gostkin⁶⁴, M. Gouighri^{136a}, D. Goujdami^{136c}, M.P. Goulette⁴⁹, A.G. Goussiou¹³⁹, C. Goy⁵, S. Gozpinar²³, H.M.X. Grabas¹³⁷, L. Graber⁵⁴, I. Grabowska-Bold^{38a}, P. Grafström^{20a,20b}, K.-J. Grahn⁴², J. Gramling⁴⁹, E. Gramstad¹¹⁸, S. Grancagnolo¹⁶, V. Grassi¹⁴⁹, V. Gratchev¹²², H.M. Gray³⁰, E. Graziani^{135a}, O.G. Grebenyuk¹²², Z.D. Greenwood^{78,n}, K. Gregersen⁷⁷, I.M. Gregor⁴², P. Grenier¹⁴⁴, J. Griffiths⁸, A.A. Grillo¹³⁸, K. Grimm⁷¹, S. Grinstein^{12,o}, Ph. Gris³⁴, Y.V. Grishkevich⁹⁸, J.-F. Grivaz¹¹⁶, J.P. Grohs⁴⁴, A. Grohsjean⁴², E. Gross¹⁷³, J. Grosse-Knetter⁵⁴, G.C. Grossi^{134a,134b}, J. Groth-Jensen¹⁷³, Z.J. Grout¹⁵⁰, L. Guan^{33b}, F. Guescini⁴⁹, D. Guest¹⁷⁷, O. Gueta¹⁵⁴, C. Guicheney³⁴, E. Guido^{50a,50b}, T. Guillemin¹¹⁶, S. Guindon², U. Gul⁵³, C. Gumpert⁴⁴, J. Gunther¹²⁷, J. Guo³⁵, S. Gupta¹¹⁹, P. Gutierrez¹¹², N.G. Gutierrez Ortiz⁵³, C. Gutsche⁷⁷, N. Guttman¹⁵⁴, C. Guyot¹³⁷, C. Gwenlan¹¹⁹, C.B. Gwilliam⁷³, A. Haas¹⁰⁹, C. Haber¹⁵, H.K. Hadavand⁸, N. Haddad^{136e}, P. Haefner²¹, S. Hageböck²¹, Z. Hajduk³⁹, H. Hakobyan¹⁷⁸, M. Haleem⁴², D. Hall¹¹⁹, G. Halladjian⁸⁹, K. Hamacher¹⁷⁶, P. Hamal¹¹⁴, K. Hamano¹⁷⁰, M. Hamer⁵⁴, A. Hamilton^{146a}, S. Hamilton¹⁶², G.N. Hamity^{146c}, P.G. Hamnett⁴², L. Han^{33b}, K. Hanagaki¹¹⁷, K. Hanawa¹⁵⁶, M. Hance¹⁵, P. Hanke^{58a}, R. Hanna¹³⁷, J.B. Hansen³⁶, J.D. Hansen³⁶, P.H. Hansen³⁶, K. Hara¹⁶¹, A.S. Hard¹⁷⁴, T. Harenberg¹⁷⁶, F. Hariri¹¹⁶, S. Harkusha⁹¹, D. Harper⁸⁸, R.D. Harrington⁴⁶, O.M. Harris¹³⁹, P.F. Harrison¹⁷¹, F. Hartjes¹⁰⁶, M. Hasegawa⁶⁶, S. Hasegawa¹⁰², Y. Hasegawa¹⁴¹, A. Hasib¹¹², S. Hassani¹³⁷, S. Haug¹⁷, M. Hauschild³⁰, R. Hauser⁸⁹, M. Havranek¹²⁶, C.M. Hawkes¹⁸, R.J. Hawkings³⁰, A.D. Hawkins⁸⁰, T. Hayashi¹⁶¹, D. Hayden⁸⁹, C.P. Hays¹¹⁹, H.S. Hayward⁷³, S.J. Haywood¹³⁰, S.J. Head¹⁸, T. Heck⁸², V. Hedberg⁸⁰, L. Heelan⁸, S. Heim¹²¹, T. Heim¹⁷⁶, B. Heinemann¹⁵, L. Heinrich¹⁰⁹, J. Hejbal¹²⁶, L. Helary²², C. Heller⁹⁹, M. Heller³⁰, S. Hellman^{147a,147b}, D. Hellmich²¹, C. Helsens³⁰, J. Henderson¹¹⁹, R.C.W. Henderson⁷¹, Y. Heng¹⁷⁴, C. Hengler⁴², A. Henrichs¹⁷⁷, A.M. Henriques Correia³⁰, S. Henrot-Versille¹¹⁶, G.H. Herbert¹⁶, Y. Hernández Jiménez¹⁶⁸, R. Herrberg-Schubert¹⁶, G. Herten⁴⁸, R. Hertenberger⁹⁹, L. Hervas³⁰, G.G. Hesketh⁷⁷, N.P. Hessey¹⁰⁶, R. Hickling⁷⁵, E. Higón-Rodríguez¹⁶⁸, E. Hill¹⁷⁰, J.C. Hill²⁸, K.H. Hiller⁴², S. Hillert²¹, S.J. Hillier¹⁸, I. Hinchliffe¹⁵, E. Hines¹²¹, M. Hirose¹⁵⁸, D. Hirschbuehl¹⁷⁶, J. Hobbs¹⁴⁹, N. Hod¹⁰⁶, M.C. Hodgkinson¹⁴⁰, P. Hodgson¹⁴⁰, A. Hoecker³⁰, M.R. Hoferkamp¹⁰⁴, F. Hoenig⁹⁹, J. Hoffman⁴⁰, D. Hoffmann⁸⁴, J.I. Hofmann^{58a}, M. Hohlfeld⁸², T.R. Holmes¹⁵, T.M. Hong¹²¹, L. Hooft van Huysduynden¹⁰⁹, W.H. Hopkins¹¹⁵, Y. Horii¹⁰², J.-Y. Hostachy⁵⁵, S. Hou¹⁵², A. Hoummada^{136a}, J. Howard¹¹⁹, J. Howarth⁴², M. Hrabovsky¹¹⁴, I. Hristova¹⁶, J. Hrivnac¹¹⁶, T. Hryn'ova⁵, C. Hsu^{146c}, P.J. Hsu⁸², S.-C. Hsu¹³⁹, D. Hu³⁵, X. Hu²⁵, Y. Huang⁴², Z. Hubacek³⁰, F. Hubaut⁸⁴, F. Huegging²¹, T.B. Huffman¹¹⁹, E.W. Hughes³⁵, G. Hughes⁷¹, M. Huhtinen³⁰, T.A. Hülsing⁸², M. Hurwitz¹⁵, N. Huseynov^{64,b}, J. Huston⁸⁹, J. Huth⁵⁷, G. Iacobucci⁴⁹, G. Iakovidis¹⁰, I. Ibragimov¹⁴², L. Iconomidou-Fayard¹¹⁶, E. Ideal¹⁷⁷, Z. Idrissi^{136e}, P. Inengo^{103a}, O. Igonkina¹⁰⁶, T. Iizawa¹⁷², Y. Ikegami⁶⁵, K. Ikematsu¹⁴², M. Ikeno⁶⁵, Y. Ilchenko^{31,p}, D. Iliadis¹⁵⁵, N. Ilic¹⁵⁹, Y. Inamaru⁶⁶, T. Ince¹⁰⁰, P. Ioannou⁹, M. Iodice^{135a}, K. Iordanidou⁹, V. Ippolito⁵⁷, A. Irles Quiles¹⁶⁸, C. Isaksson¹⁶⁷, M. Ishino⁶⁷, M. Ishitsuka¹⁵⁸, R. Ishmukhametov¹¹⁰, C. Issever¹¹⁹, S. Istin^{19a}, J.M. Iturbe Ponce⁸³, R. Iuppa^{134a,134b}, J. Ivarsson⁸⁰, W. Iwanski³⁹, H. Iwasaki⁶⁵, J.M. Izen⁴¹, V. Izzo^{103a}, B. Jackson¹²¹, M. Jackson⁷³, P. Jackson¹, M.R. Jaekel³⁰, V. Jain², K. Jakobs⁴⁸, S. Jakobsen³⁰, T. Jakoubek¹²⁶, J. Jakubek¹²⁷, D.O. Jamin¹⁵², D.K. Jana⁷⁸, E. Jansen⁷⁷, H. Jansen³⁰, J. Janssen²¹, M. Janus¹⁷¹, G. Jarlskog⁸⁰, N. Javadov^{64,b}, T. Javůrek⁴⁸, L. Jeanty¹⁵, J. Jejelava^{51a,q}, G.-Y. Jeng¹⁵¹, D. Jennens⁸⁷, P. Jenni^{48,r}, J. Jentsch⁴³, C. Jeske¹⁷¹, S. Jézéquel⁵, H. Ji¹⁷⁴, J. Jia¹⁴⁹, Y. Jiang^{33b}, M. Jimenez Belenguer⁴², S. Jin^{33a}, A. Jinaru^{26a}, O. Jinnouchi¹⁵⁸, M.D. Joergensen³⁶, K.E. Johansson^{147a,147b}, P. Johansson¹⁴⁰, K.A. Johns⁷, K. Jon-And^{147a,147b}, G. Jones¹⁷¹, R.W.L. Jones⁷¹, T.J. Jones⁷³, J. Jongmanns^{58a}, P.M. Jorge^{125a,125b}, K.D. Joshi⁸³, J. Jovicevic¹⁴⁸, X. Ju¹⁷⁴, C.A. Jung⁴³, R.M. Jungst³⁰, P. Jussel⁶¹, A. Juste Rozas^{12,o}, M. Kaci¹⁶⁸, A. Kaczmarska³⁹, M. Kado¹¹⁶, H. Kagan¹¹⁰, M. Kagan¹⁴⁴, E. Kajomovitz⁴⁵, C.W. Kalderon¹¹⁹, S. Kama⁴⁰, A. Kamenshchikov¹²⁹, N. Kanaya¹⁵⁶, M. Kaneda³⁰, S. Kaneti²⁸, V.A. Kantserov⁹⁷, J. Kanzaki⁶⁵, B. Kaplan¹⁰⁹, A. Kapliy³¹, D. Kar⁵³, K. Karakostas¹⁰, N. Karastathis¹⁰, M.J. Kareem⁵⁴, M. Karnevskiy⁸², S.N. Karpov⁶⁴, Z.M. Karpova⁶⁴, K. Karthik¹⁰⁹, V. Kartvelishvili⁷¹, A.N. Karyukhin¹²⁹, L. Kashif¹⁷⁴, G. Kasieczka^{58b}, R.D. Kass¹¹⁰, A. Kastanas¹⁴, Y. Kataoka¹⁵⁶, A. Katre⁴⁹, J. Katzy⁴², V. Kaushik⁷, K. Kawagoe⁶⁹, T. Kawamoto¹⁵⁶, G. Kawamura⁵⁴, S. Kazama¹⁵⁶, V.F. Kazanin¹⁰⁸, M.Y. Kazarinov⁶⁴, R. Keeler¹⁷⁰, R. Kehoe⁴⁰, M. Keil⁵⁴, J.S. Keller⁴², J.J. Kempster⁷⁶, H. Keoshkerian⁵, O. Kepka¹²⁶, B.P. Kerševan⁷⁴, S. Kersten¹⁷⁶, K. Kessoku¹⁵⁶, J. Keung¹⁵⁹, F. Khalil-zada¹¹, H. Khandanyan^{147a,147b}, A. Khanov¹¹³, A. Khodinov⁹⁷, A. Khomich^{58a}, T.J. Khoo²⁸, G. Khoriali²¹, A. Khoroshilov¹⁷⁶, V. Khovanskiy⁹⁶, E. Khramov⁶⁴, J. Khubua^{51b}, H.Y. Kim⁸, H. Kim^{147a,147b}, S.H. Kim¹⁶¹, N. Kimura¹⁷², O. Kind¹⁶, B.T. King⁷³, M. King¹⁶⁸, R.S.B. King¹¹⁹, S.B. King¹⁶⁹, J. Kirk¹³⁰, A.E. Kiryunin¹⁰⁰, T. Kishimoto⁶⁶, D. Kisielevska^{38a}, F. Kiss⁴⁸, T. Kittelmann¹²⁴, K. Kiuchi¹⁶¹, E. Kladiva^{145b}, M. Klein⁷³, U. Klein⁷³, K. Kleinknecht⁸², P. Klimek^{147a,147b}, A. Klimentov²⁵, R. Klingenberg⁴³, J.A. Klinger⁸³, T. Klioutchnikova³⁰, P.F. Klok¹⁰⁵, E.-E. Kluge^{58a}, P. Kluit¹⁰⁶, S. Kluth¹⁰⁰, E. Kneringer⁶¹, E.B.F.G. Knoops⁸⁴, A. Knue⁵³, D. Kobayashi¹⁵⁸, T. Kobayashi¹⁵⁶, M. Kobel⁴⁴, M. Kocian¹⁴⁴, P. Kodys¹²⁸, P. Koevesarki²¹, T. Koffas²⁹, E. Koffeman¹⁰⁶, L.A. Kogan¹¹⁹, S. Kohlmann¹⁷⁶, Z. Kohout¹²⁷, T. Kohriki⁶⁵, T. Koi¹⁴⁴, H. Kolanoski¹⁶, I. Koletsou⁵, J. Koll⁸⁹, A.A. Komar^{95,*}, Y. Komori¹⁵⁶, T. Kondo⁶⁵, N. Kondrashova⁴², K. Köneke⁴⁸, A.C. König¹⁰⁵, S. König⁸², T. Kono^{65,s},

R. Konoplich^{109,t}, N. Konstantinidis⁷⁷, R. Kopelianny¹⁵³, S. Koperny^{38a}, L. Köpke⁸², A.K. Kopp⁴⁸, K. Korcyl³⁹, K. Kordas¹⁵⁵, A. Korn⁷⁷, A.A. Korol^{108,c}, I. Korolkov¹², E.V. Korolkova¹⁴⁰, V.A. Korotkov¹²⁹, O. Kortner¹⁰⁰, S. Kortner¹⁰⁰, V.V. Kostyukhin²¹, V.M. Kotov⁶⁴, A. Kotwal⁴⁵, C. Kourkoumelis⁹, V. Kouskoura¹⁵⁵, A. Koutsman^{160a}, R. Kowalewski¹⁷⁰, T.Z. Kowalski^{38a}, W. Kozanecki¹³⁷, A.S. Kozhin¹²⁹, V. Kral¹²⁷, V.A. Kramarenko⁹⁸, G. Kramberger⁷⁴, D. Krasnopevtsev⁹⁷, M.W. Krasny⁷⁹, A. Krasznahorkay³⁰, J.K. Kraus²¹, A. Kravchenko²⁵, S. Kreiss¹⁰⁹, M. Kretz^{58c}, J. Kretzschmar⁷³, K. Kreutzfeldt⁵², P. Krieger¹⁵⁹, K. Kroeninger⁵⁴, H. Kroha¹⁰⁰, J. Kroll¹²¹, J. Kroseberg²¹, J. Krstic^{13a}, U. Kruchonak⁶⁴, H. Krüger²¹, T. Kruker¹⁷, N. Krumnack⁶³, Z.V. Krumshteyn⁶⁴, A. Kruse¹⁷⁴, M.C. Kruse⁴⁵, M. Kruskal²², T. Kubota⁸⁷, S. Kuday^{4a}, S. Kuehn⁴⁸, A. Kugel^{58c}, A. Kuhl¹³⁸, T. Kuhl⁴², V. Kukhtin⁶⁴, Y. Kulchitsky⁹¹, S. Kuleshov^{32b}, M. Kuna^{133a,133b}, J. Kunkle¹²¹, A. Kupco¹²⁶, H. Kurashige⁶⁶, Y.A. Kurochkin⁹¹, R. Kurumida⁶⁶, V. Kus¹²⁶, E.S. Kuwertz¹⁴⁸, M. Kuze¹⁵⁸, J. Kvita¹¹⁴, A. La Rosa⁴⁹, L. La Rotonda^{37a,37b}, C. Lacasta¹⁶⁸, F. Lacava^{133a,133b}, J. Lacey²⁹, H. Lacker¹⁶, D. Lacour⁷⁹, V.R. Lacuesta¹⁶⁸, E. Ladygin⁶⁴, R. Lafaye⁵, B. Laforge⁷⁹, T. Lagouri¹⁷⁷, S. Lai⁴⁸, H. Laier^{58a}, L. Lambourne⁷⁷, S. Lammers⁶⁰, C.L. Lampen⁷, W. Lampl⁷, E. Lançon¹³⁷, U. Landgraf⁴⁸, M.P.J. Landon⁷⁵, V.S. Lang^{58a}, A.J. Lankford¹⁶⁴, F. Lanni²⁵, K. Lantzscho³⁰, S. Laplace⁷⁹, C. Lapoire²¹, J.F. Laporte¹³⁷, T. Lari^{90a}, F. Lasagni Manghi^{20a,20b}, M. Lassnig³⁰, P. Laurelli⁴⁷, W. Lavrijsen¹⁵, A.T. Law¹³⁸, P. Laycock⁷³, O. Le Dortz⁷⁹, E. Le Guirriec⁸⁴, E. Le Menedeu¹², T. LeCompte⁶, F. Ledroit-Guillon⁵⁵, C.A. Lee¹⁵², H. Lee¹⁰⁶, J.S.H. Lee¹¹⁷, S.C. Lee¹⁵², L. Lee¹, G. Lefebvre⁷⁹, M. Lefebvre¹⁷⁰, F. Legger⁹⁹, C. Leggett¹⁵, A. Lehan⁷³, M. Lehman²¹, G. Lehmann Miotto³⁰, X. Lei⁷, W.A. Leight²⁹, A. Leisos¹⁵⁵, A.G. Leister¹⁷⁷, M.A.L. Leite^{24d}, R. Leitner¹²⁸, D. Lellouch¹⁷³, B. Lemmer⁵⁴, K.J.C. Leney⁷⁷, T. Lenz²¹, G. Lenzen¹⁷⁶, B. Lenzi³⁰, R. Leone⁷, S. Leone^{123a,123b}, C. Leonidopoulos⁴⁶, S. Leontsinis¹⁰, C. Leroy⁹⁴, C.G. Lester²⁸, C.M. Lester¹²¹, M. Levchenko¹²², J. Levêque⁵, D. Levin⁸⁸, L.J. Levinson¹⁷³, M. Levy¹⁸, A. Lewis¹¹⁹, G.H. Lewis¹⁰⁹, A.M. Leyko²¹, M. Leyton⁴¹, B. Li^{33b,u}, B. Li⁸⁴, H. Li¹⁴⁹, H.L. Li³¹, L. Li⁴⁵, L. Li^{33e}, S. Li⁴⁵, Y. Li^{33c,v}, Z. Liang¹³⁸, H. Liao³⁴, B. Liberti^{134a}, P. Lichard³⁰, K. Lie¹⁶⁶, J. Liebal²¹, W. Liebig¹⁴, C. Limbach²¹, A. Limosani⁸⁷, S.C. Lin^{152,w}, T.H. Lin⁸², F. Linde¹⁰⁶, B.E. Lindquist¹⁴⁹, J.T. Linnemann⁸⁹, E. Lipeles¹²¹, A. Lipniacka¹⁴, M. Lisovsky⁴², T.M. Liss¹⁶⁶, D. Lissauer²⁵, A. Lister¹⁶⁹, A.M. Litke¹³⁸, B. Liu¹⁵², D. Liu¹⁵², J.B. Liu^{33b}, K. Liu^{33b,x}, L. Liu⁸⁸, M. Liu⁴⁵, M. Liu^{33b}, Y. Liu^{33b}, M. Livan^{120a,120b}, S.S.A. Livermore¹¹⁹, A. Lleres⁵⁵, J. Llorente Merino⁸¹, S.L. Lloyd⁷⁵, F. Lo Sterzo¹⁵², E. Lobodzinska⁴², P. Loch⁷, W.S. Lockman¹³⁸, T. Lodenkoetter²¹, F.K. Loebinger⁸³, A.E. Loevschall-Jensen³⁶, A. Loginov¹⁷⁷, T. Lohse¹⁶, K. Lohwasser⁴², M. Lokajicek¹²⁶, V.P. Lombardo⁵, B.A. Long²², J.D. Long⁸⁸, R.E. Long⁷¹, L. Lopes^{125a}, D. Lopez Mateos⁵⁷, B. Lopez Paredes¹⁴⁰, I. Lopez Paz¹², J. Lorenz⁹⁹, N. Lorenzo Martinez⁶⁰, M. Losada¹⁶³, P. Loscutto¹⁵, X. Lou⁴¹, A. Lounis¹¹⁶, J. Love⁶, P.A. Love⁷¹, A.J. Lowe^{144,f}, F. Lu^{33a}, N. Lu⁸⁸, H.J. Lubatti¹³⁹, C. Luci^{133a,133b}, A. Lucotte⁵⁵, F. Luehring⁶⁰, W. Lukas⁶¹, L. Luminari^{133a}, O. Lundberg^{147a,147b}, B. Lund-Jensen¹⁴⁸, M. Lungwitz⁸², D. Lynn²⁵, R. Lysak¹²⁶, E. Lytken⁸⁰, H. Ma²⁵, L.L. Ma^{33d}, G. Maccarrone⁴⁷, A. Macchiolo¹⁰⁰, J. Machado Miguens^{125a,125b}, D. Macina³⁰, D. Madaffari⁸⁴, R. Madar⁴⁸, H.J. Maddocks⁷¹, W.F. Mader⁴⁴, A. Madsen¹⁶⁷, M. Maeno⁸, T. Maeno²⁵, A. Maevskiy⁹⁸, E. Magradze⁵⁴, K. Mahboubi⁴⁸, J. Mahlstedt¹⁰⁶, S. Mahmoud⁷³, C. Maiani¹³⁷, C. Maidantchik^{24a}, A.A. Maier¹⁰⁰, A. Maio^{125a,125b,125d}, S. Majewski¹¹⁵, Y. Makida⁶⁵, N. Makovec¹¹⁶, P. Mal^{137,y}, B. Malaescu⁷⁹, Pa. Malecki³⁹, V.P. Maleev¹²², F. Malek⁵⁵, U. Mallik⁶², D. Malon⁶, C. Malone¹⁴⁴, S. Maltezos¹⁰, V.M. Malyshev¹⁰⁸, S. Malyukov³⁰, J. Mamuzic^{13b}, B. Mandelli³⁰, L. Mandelli^{90a}, I. Mandić⁷⁴, R. Mandrysch⁶², J. Maneira^{125a,125b}, A. Manfredini¹⁰⁰, L. Manhaes de Andrade Filho^{24b}, J.A. Manjarres Ramos^{160b}, A. Mann⁹⁹, P.M. Manning¹³⁸, A. Manousakis-Katsikakis⁹, B. Mansoulie¹³⁷, R. Mantifel⁸⁶, L. Mapelli³⁰, L. March^{146c}, J.F. Marchand²⁹, G. Marchiori⁷⁹, M. Marcisovsky¹²⁶, C.P. Marino¹⁷⁰, M. Marjanovic^{13a}, C.N. Marques^{125a}, F. Marroquin^{24a}, S.P. Marsden⁸³, Z. Marshall¹⁵, L.F. Marti¹⁷, S. Marti-Garcia¹⁶⁸, B. Martin³⁰, B. Martin⁸⁹, T.A. Martin¹⁷¹, V.J. Martin⁴⁶, B. Martin dit Latour¹⁴, H. Martinez¹³⁷, M. Martinez^{12,o}, S. Martin-Haugh¹³⁰, A.C. Martyniuk⁷⁷, M. Marx¹³⁹, F. Marzano^{133a}, A. Marzin³⁰, L. Masetti⁸², T. Mashimo¹⁵⁶, R. Mashinistov⁹⁵, J. Masik⁸³, A.L. Maslennikov^{108,c}, I. Massa^{20a,20b}, L. Massa^{20a,20b}, N. Massol⁵, P. Mastrandrea¹⁴⁹, A. Mastroberardino^{37a,37b}, T. Masubuchi¹⁵⁶, P. Mättig¹⁷⁶, J. Mattmann⁸², J. Maurer^{26a}, S.J. Maxfield⁷³, D.A. Maximov^{108,c}, R. Mazini¹⁵², L. Mazzaferro^{134a,134b}, G. Mc Goldrick¹⁵⁹, S.P. Mc Kee⁸⁸, A. McCarn⁸⁸, R.L. McCarthy¹⁴⁹, T.G. McCarthy²⁹, N.A. McCubbin¹³⁰, K.W. McFarlane^{56,*}, J.A. McFayden⁷⁷, G. Mchedlidge⁵⁴, S.J. McMahon¹³⁰, R.A. McPherson^{170,j}, J. Mechnich¹⁰⁶, M. Medinnis⁴², S. Meehan³¹, S. Mehlhase⁹⁹, A. Mehta⁷³, K. Meier^{58a}, C. Meineck⁹⁹, B. Meirose⁸⁰, C. Melachrinou³¹, B.R. Mellado Garcia^{146c}, F. Meloni¹⁷, A. Mengarelli^{20a,20b}, S. Menke¹⁰⁰, E. Meoni¹⁶², K.M. Mercurio⁵⁷, S. Mergelmeyer²¹, N. Meric¹³⁷, P. Mermod⁴⁹, L. Merola^{103a,103b}, C. Meroni^{90a}, F.S. Merritt³¹, H. Merritt¹¹⁰, A. Messina^{30,z}, J. Metcalfe²⁵, A.S. Mete¹⁶⁴, C. Meyer⁸², C. Meyer¹²¹, J-P. Meyer¹³⁷, J. Meyer³⁰, R.P. Middleton¹³⁰, S. Migas⁷³, L. Mijović²¹, G. Mikenberg¹⁷³, M. Mikesikova¹²⁶, M. Mikuz⁷⁴, A. Milic³⁰, D.W. Miller³¹, C. Mills⁴⁶, A. Milov¹⁷³, D.A. Milstead^{147a,147b}, D. Milstein¹⁷³, A.A. Minaenko¹²⁹, Y. Minami¹⁵⁶, I.A. Minashvili⁶⁴, A.I. Mincer¹⁰⁹, B. Mindur^{38a}, M. Mineev⁶⁴, Y. Ming¹⁷⁴, L.M. Mir¹², G. Mirabelli^{133a}, T. Mitani¹⁷², J. Mitrevski⁹⁹, V.A. Mitsou¹⁶⁸, S. Mitsui⁶⁵, A. Miucci⁴⁹, P.S. Miyagawa¹⁴⁰, J.U. Mjörnmark⁸⁰, T. Moe^{147a,147b}, K. Mochizuki⁸⁴, S. Mohapatra³⁵, W. Mohr⁴⁸, S. Molander^{147a,147b}, R. Moles-Valls¹⁶⁸, K. Mönig⁴², C. Monini⁵⁵, J. Monk³⁶, E. Monnier⁸⁴, J. Montejo Berlingen¹², F. Monticelli⁷⁰, S. Monzani^{133a,133b}, R.W. Moore³, N. Morange⁶², D. Moreno⁸², M. Moreno Llácer⁵⁴, P. Morettini^{50a}, M. Morgenstern⁴⁴, M. Morii⁵⁷, S. Moritz⁸², A.K. Morley¹⁴⁸, G. Mornacchi³⁰, J.D. Morris⁷⁵, L. Morvaj¹⁰², H.G. Moser¹⁰⁰, M. Mosidze^{51b}, J. Moss¹¹⁰, K. Motohashi¹⁵⁸, R. Mount¹⁴⁴, E. Mountricha²⁵, S.V. Mouraviev^{95,*}, E.J.W. Moyse⁸⁵, S. Muanza⁸⁴, R.D. Mudd¹⁸, F. Mueller^{58a}, J. Mueller¹²⁴, K. Mueller²¹, T. Mueller²⁸, T. Mueller⁸², D. Muenstermann⁴⁹, Y. Munwes¹⁵⁴, J.A. Murillo Quijada¹⁸, W.J. Murray^{171,130}, H. Musheghyan⁵⁴, E. Musto¹⁵³, A.G. Myagkov^{129,aa}, M. Myska¹²⁷, O. Nackenhorst⁵⁴, J. Nadal⁵⁴, K. Nagai⁶¹, R. Nagai¹⁵⁸, Y. Nagai⁸⁴, K. Nagano⁶⁵, A. Nagarkar¹¹⁰, Y. Nagasaka⁵⁹, M. Nagel¹⁰⁰, A.M. Nairz³⁰, Y. Nakahama³⁰, K. Nakamura⁶⁵, T. Nakamura¹⁵⁶, I. Nakano¹¹¹,

H. Namasivayam⁴¹, G. Nanava²¹, R. Narayan^{58b}, T. Nattermann²¹, T. Naumann⁴², G. Navarro¹⁶³, R. Nayyar⁷, H.A. Neal⁸⁸, P.Yu. Nechaeva⁹⁵, T.J. Neep⁸³, P.D. Nef¹⁴⁴, A. Negri^{120a,120b}, G. Negri³⁰, M. Negrini^{20a}, S. Nektarijevic⁴⁹, C. Nellist¹¹⁶, A. Nelson¹⁶⁴, T.K. Nelson¹⁴⁴, S. Nemecek¹²⁶, P. Nemethy¹⁰⁹, A.A. Nepomuceno^{24a}, M. Nessi^{30,ab}, M.S. Neubauer¹⁶⁶, M. Neumann¹⁷⁶, R.M. Neves¹⁰⁹, P. Nevski²⁵, P.R. Newman¹⁸, D.H. Nguyen⁶, R.B. Nickerson¹¹⁹, R. Nicolaidou¹³⁷, B. Nicquevert³⁰, J. Nielsen¹³⁸, N. Nikiforou³⁵, A. Nikiforov¹⁶, V. Nikolaenko^{129,aa}, I. Nikolic-Audit⁷⁹, K. Nikolics⁴⁹, K. Nikolopoulos¹⁸, P. Nilsson⁸, Y. Ninomiya¹⁵⁶, A. Nisati^{133a}, R. Nisius¹⁰⁰, T. Nobe¹⁵⁸, L. Nodulman⁶, M. Nomachi¹¹⁷, I. Nomidis²⁹, S. Norberg¹¹², M. Nordberg³⁰, O. Novgorodova⁴⁴, S. Nowak¹⁰⁰, M. Nozaki⁶⁵, L. Nozka¹¹⁴, K. Ntekas¹⁰, G. Nunes Hanninger⁸⁷, T. Nunnemann⁹⁹, E. Nurse⁷⁷, F. Nuti⁸⁷, B.J. O'Brien⁴⁶, F. O'grady⁷, D.C. O'Neil¹⁴³, V. O'Shea⁵³, F.G. Oakham^{29,e}, H. Oberlack¹⁰⁰, T. Obermann²¹, J. Ocariz⁷⁹, A. Ochi⁶⁶, M.I. Ochoa⁷⁷, S. Oda⁶⁹, S. Odaka⁶⁵, H. Ogren⁶⁰, A. Oh⁸³, S.H. Oh⁴⁵, C.C. Ohm¹⁵, H. Ohman¹⁶⁷, W. Okamura¹¹⁷, H. Okawa²⁵, Y. Okumura³¹, T. Okuyama¹⁵⁶, A. Olariu^{26a}, A.G. Olchevski⁶⁴, S.A. Olivares Pino⁴⁶, D. Oliveira Damazio²⁵, E. Oliver Garcia¹⁶⁸, A. Olszewski³⁹, J. Olszowska³⁹, A. Onofre^{125a,125e}, P.U.E. Onyisi^{31,p}, C.J. Oram^{160a}, M.J. Oreglia³¹, Y. Oren¹⁵⁴, D. Orestano^{135a,135b}, N. Orlando^{72a,72b}, C. Oropeza Barrera⁵³, R.S. Orr¹⁵⁹, B. Osculati^{50a,50b}, R. Ospanov¹²¹, G. Otero y Garzon²⁷, H. Otono⁶⁹, M. Ouchrif^{136d}, E.A. Ouellette¹⁷⁰, F. Ould-Saada¹¹⁸, A. Ouraou¹³⁷, K.P. Oussoren¹⁰⁶, Q. Ouyang^{33a}, A. Ovcharova¹⁵, M. Owen⁸³, V.E. Ozcan^{19a}, N. Ozturk⁸, K. Pachal¹¹⁹, A. Pacheco Pages¹², C. Padilla Aranda¹², M. Pagáčová⁴⁸, S. Pagan Griso¹⁵, E. Paganis¹⁴⁰, C. Pahl¹⁰⁰, F. Paige²⁵, P. Pais⁸⁵, K. Pajchel¹¹⁸, G. Palacino^{160b}, S. Palestini³⁰, M. Palka^{38b}, D. Pallin³⁴, A. Palma^{125a,125b}, J.D. Palmer¹⁸, Y.B. Pan¹⁷⁴, E. Panagiotopoulou¹⁰, J.G. Panduro Vazquez⁷⁶, P. Pani¹⁰⁶, N. Panikashvili⁸⁸, S. Panitkin²⁵, D. Pantea^{26a}, L. Paolozzi^{134a,134b}, Th.D. Papadopoulou¹⁰, K. Papageorgiou^{155,m}, A. Paramonov⁶, D. Paredes Hernandez³⁴, M.A. Parker²⁸, F. Parodi^{50a,50b}, J.A. Parsons³⁵, U. Parzefall⁴⁸, E. Pasqualucci^{133a}, S. Passaggio^{50a}, A. Passeri^{135a}, F. Pastore^{135a,135b,*}, Fr. Pastore⁷⁶, G. Pásztor²⁹, S. Pataria¹⁷⁶, N.D. Patel¹⁵¹, J.R. Pater⁸³, S. Patricelli^{103a,103b}, T. Pauly³⁰, J. Pearce¹⁷⁰, L.E. Pedersen³⁶, M. Pedersen¹¹⁸, S. Pedraza Lopez¹⁶⁸, R. Pedro^{125a,125b}, S.V. Peleganchuk¹⁰⁸, D. Pelikan¹⁶⁷, H. Peng^{33b}, B. Penning³¹, J. Penwell⁶⁰, D.V. Perepelitsa²⁵, E. Perez Codina^{160a}, M.T. Pérez García-Estañ¹⁶⁸, V. Perez Reale³⁵, L. Perini^{90a,90b}, H. Pernegger³⁰, S. Perrella^{103a,103b}, R. Perrino^{72a}, R. Peschke⁴², V.D. Peshekhonov⁶⁴, K. Peters³⁰, R.F.Y. Peters⁸³, B.A. Petersen³⁰, T.C. Petersen³⁶, E. Petit⁴², A. Petridis^{147a,147b}, C. Petridou¹⁵⁵, E. Petrolo^{133a}, F. Petrucci^{135a,135b}, N.E. Pettersson¹⁵⁸, R. Pezoa^{32b}, P.W. Phillips¹³⁰, G. Piacquadio¹⁴⁴, E. Pianori¹⁷¹, A. Picazio⁴⁹, E. Piccaro⁷⁵, M. Piccinini^{20a,20b}, R. Piegai²⁷, D.T. Pignotti¹¹⁰, J.E. Pilcher³¹, A.D. Pilkington⁷⁷, J. Pina^{125a,125b,125d}, M. Pinamonti^{165a,165c,ac}, A. Pinder¹¹⁹, J.L. Pinfold³, A. Pingel³⁶, B. Pinto^{125a}, S. Pires⁷⁹, M. Pitt¹⁷³, C. Pizio^{90a,90b}, L. Plazak^{145a}, M.-A. Pleier²⁵, V. Pleskot¹²⁸, E. Plotnikova⁶⁴, P. Plucinski^{147a,147b}, S. Poddar^{58a}, F. Podlyski³⁴, R. Poettgen⁸², L. Poggioli¹¹⁶, D. Pohl²¹, M. Pohl⁴⁹, G. Polesello^{120a}, A. Policicchio^{37a,37b}, R. Polifka¹⁵⁹, A. Polini^{20a}, C.S. Pollard⁴⁵, V. Polychronakos²⁵, K. Pommès³⁰, L. Pontecorvo^{133a}, B.G. Pope⁸⁹, G.A. Popeneciu^{26b}, D.S. Popovic^{13a}, A. Poppleton³⁰, X. Portell Bueso¹², S. Pospisil¹²⁷, K. Potamianos¹⁵, I.N. Potrap⁶⁴, C.J. Potter¹⁵⁰, C.T. Potter¹¹⁵, G. Poulard³⁰, J. Poveda⁶⁰, V. Pozdnyakov⁶⁴, P. Pralavorio⁸⁴, A. Pranko¹⁵, S. Prasad³⁰, R. Pravahan⁸, S. Prell⁶³, D. Price⁸³, J. Price⁷³, L.E. Price⁶, D. Prieur¹²⁴, M. Primavera^{72a}, M. Proissl⁴⁶, K. Prokofiev⁴⁷, F. Prokoshin^{32b}, E. Protopapadaki¹³⁷, S. Protopopescu²⁵, J. Proudfoot⁶, M. Przybycien^{38a}, H. Przysieznik⁵, E. Ptacek¹¹⁵, D. Puddu^{135a,135b}, E. Pueschel⁸⁵, D. Poldon¹⁴⁹, M. Purohit^{25,ad}, P. Puzo¹¹⁶, J. Qian⁸⁸, G. Qin⁵³, Y. Qin⁸³, A. Quadri⁵⁴, D.R. Quarrie¹⁵, W.B. Quayle^{165a,165b}, M. Queitsch-Maitland⁸³, D. Quilty⁵³, A. Qureshi^{160b}, V. Radeka²⁵, V. Radescu⁴², S.K. Radhakrishnan¹⁴⁹, P. Radloff¹¹⁵, P. Rados⁸⁷, F. Ragusa^{90a,90b}, G. Rahal¹⁷⁹, S. Rajagopalan²⁵, M. Rammensee³⁰, A.S. Randle-Conde⁴⁰, C. Rangel-Smith¹⁶⁷, K. Rao¹⁶⁴, F. Rauscher⁹⁹, T.C. Rave⁴⁸, T. Ravenscroft⁵³, M. Raymond³⁰, A.L. Read¹¹⁸, N.P. Readioff⁷³, D.M. Rebuffi^{120a,120b}, A. Redelbach¹⁷⁵, G. Redlinger²⁵, R. Reece¹³⁸, K. Reeves⁴¹, L. Rehnisch¹⁶, H. Reisin²⁷, M. Relich¹⁶⁴, C. Rembser³⁰, H. Ren^{33a}, Z.L. Ren¹⁵², A. Renaud¹¹⁶, M. Rescigno^{133a}, S. Resconi^{90a}, O.L. Rezanova^{108,c}, P. Reznicek¹²⁸, R. Rezvani⁹⁴, R. Richter¹⁰⁰, M. Ridel⁷⁹, P. Rieck¹⁶, J. Rieger⁵⁴, M. Rijssenbeek¹⁴⁹, A. Rimoldi^{120a,120b}, L. Rinaldi^{20a}, E. Ritsch⁶¹, I. Riu¹², F. Rizatdinova¹¹³, E. Rizvi⁷⁵, S.H. Robertson^{86,j}, A. Robichaud-Veronneau⁸⁶, D. Robinson²⁸, J.E.M. Robinson⁸³, A. Robson⁵³, C. Roda^{123a,123b}, L. Rodrigues³⁰, S. Roe³⁰, O. Røhne¹¹⁸, S. Rolli¹⁶², A. Romaniouk⁹⁷, M. Romano^{20a,20b}, E. Romero Adam¹⁶⁸, N. Rompotis¹³⁹, M. Ronzani⁴⁸, L. Roos⁷⁹, E. Ros¹⁶⁸, S. Rosati^{133a}, K. Rosbach⁴⁹, M. Rose⁷⁶, P. Rose¹³⁸, P.L. Rosendahl¹⁴, O. Rosenthal¹⁴², V. Rossetti^{147a,147b}, E. Rossi^{103a,103b}, L.P. Rossi^{50a}, R. Rosten¹³⁹, M. Rotaru^{26a}, I. Roth¹⁷³, J. Rothberg¹³⁹, D. Rousseau¹¹⁶, C.R. Royon¹³⁷, A. Rozanov⁸⁴, Y. Rozen¹⁵³, X. Ruan^{146c}, F. Rubbo¹², I. Rubinskiy⁴², V.I. Rud⁹⁸, C. Rudolph⁴⁴, M.S. Rudolph¹⁵⁹, F. Rühr⁴⁸, A. Ruiz-Martinez³⁰, Z. Rurikova⁴⁸, N.A. Rusakovich⁶⁴, A. Ruschke⁹⁹, J.P. Rutherford⁷, N. Ruthmann⁴⁸, Y.F. Ryabov¹²², M. Rybar¹²⁸, G. Rybkin¹¹⁶, N.C. Ryder¹¹⁹, A.F. Saavedra¹⁵¹, G. Sabato¹⁰⁶, S. Sacerdoti²⁷, A. Saddique³, I. Sadeh¹⁵⁴, H.F.-W. Sadrozinski¹³⁸, R. Sadykov⁶⁴, F. Safai Tehrani^{133a}, H. Sakamoto¹⁵⁶, Y. Sakurai¹⁷², G. Salamanna^{135a,135b}, A. Salamon^{134a}, M. Saleem¹¹², D. Salek¹⁰⁶, P.H. Sales De Bruin¹³⁹, D. Salihagic¹⁰⁰, A. Salnikov¹⁴⁴, J. Salt¹⁶⁸, D. Salvatore^{37a,37b}, F. Salvatore¹⁵⁰, A. Salvucci¹⁰⁵, A. Salzburger³⁰, D. Sampsonidis¹⁵⁵, A. Sanchez^{103a,103b}, J. Sánchez¹⁶⁸, V. Sanchez Martinez¹⁶⁸, H. Sandaker¹⁴, R.L. Sandbach⁷⁵, H.G. Sander⁸², M.P. Sanders⁹⁹, M. Sandhoff¹⁷⁶, T. Sandoval²⁸, C. Sandoval¹⁶³, R. Sandstrom¹⁰⁰, D.P.C. Sankey¹³⁰, A. Sansoni⁴⁷, C. Santoni³⁴, R. Santonico^{134a,134b}, H. Santos^{125a}, I. Santoyo Castillo¹⁵⁰, K. Sapp¹²⁴, A. Sapronov⁶⁴, J.G. Saraiva^{125a,125d}, B. Sarrazin²¹, G. Sartisohn¹⁷⁶, O. Sasaki⁶⁵, Y. Sasaki¹⁵⁶, G. Sauvage^{5,*}, E. Sauvan⁵, P. Savard^{159,e}, D.O. Savu³⁰, C. Sawyer¹¹⁹, L. Sawyer^{78,n}, D.H. Saxon⁵³, J. Saxon¹²¹, C. Sbarra^{20a}, A. Sbrizzi^{20a,20b}, T. Scanlon⁷⁷, D.A. Scannicchio¹⁶⁴, M. Scarcella¹⁵¹, V. Scarfone^{37a,37b}, J. Schaarschmidt¹⁷³, P. Schacht¹⁰⁰, D. Schaefer³⁰, R. Schaefer⁴², S. Schaepe²¹, S. Schaezel^{58b}, U. Schäfer⁸², A.C. Schaffer¹¹⁶, D. Schaile⁹⁹, R.D. Schamberger¹⁴⁹, V. Scharf^{58a}, V.A. Schegelsky¹²², D. Scheirich¹²⁸, M. Schernau¹⁶⁴, M.I. Scherzer³⁵, C. Schiavi^{50a,50b}, J. Schieck⁹⁹, C. Schillo⁴⁸, M. Schioppa^{37a,37b}, S. Schlenker³⁰,

E. Schmidt⁴⁸, K. Schmieden³⁰, C. Schmitt⁸², S. Schmitt^{58b}, B. Schneider¹⁷, Y.J. Schnellbach⁷³, U. Schnoor⁴⁴, L. Schoeffel¹³⁷, A. Schoening^{58b}, B.D. Schoenrock⁸⁹, A.L.S. Schorlemmer⁵⁴, M. Schott⁸², D. Schouten^{160a}, J. Schovancova²⁵, S. Schramm¹⁵⁹, M. Schreyer¹⁷⁵, C. Schroeder⁸², N. Schuh⁸², M.J. Schultens²¹, H.-C. Schultz-Coulon^{58a}, H. Schulz¹⁶, M. Schumacher⁴⁸, B.A. Schumm¹³⁸, Ph. Schune¹³⁷, C. Schwanenberger⁸³, A. Schwartzman¹⁴⁴, T.A. Schwarz⁸⁸, Ph. Schwegler¹⁰⁰, Ph. Schwemling¹³⁷, R. Schwienhorst⁸⁹, J. Schwindling¹³⁷, T. Schwindt²¹, M. Schwoerer⁵, F.G. Sciacca¹⁷, E. Scifo¹¹⁶, G. Sciolla²³, W.G. Scott¹³⁰, F. Scuri^{123a,123b}, F. Scutti²¹, J. Searcy⁸⁸, G. Sedov⁴², E. Sedykh¹²², S.C. Seidel¹⁰⁴, A. Seiden¹³⁸, F. Seifert¹²⁷, J.M. Seixas^{24a}, G. Sekhniaidze^{103a}, S.J. Sekula⁴⁰, K.E. Selbach⁴⁶, D.M. Seliverstov^{122,*}, G. Sellers⁷³, N. Semprini-Cesari^{20a,20b}, C. Serfon³⁰, L. Serin¹¹⁶, L. Serkin⁵⁴, T. Serre⁸⁴, R. Seuster^{160a}, H. Severini¹¹², T. Sfiligoj⁷⁴, F. Sforza¹⁰⁰, A. Sfyrla³⁰, E. Shabalina⁵⁴, M. Shamim¹¹⁵, L.Y. Shan^{33a}, R. Shang¹⁶⁶, J.T. Shank²², M. Shapiro¹⁵, P.B. Shatalov⁹⁶, K. Shaw^{165a,165b}, C.Y. Shehu¹⁵⁰, P. Sherwood⁷⁷, L. Shi^{152,ae}, S. Shimizu⁶⁶, C.O. Shimmin¹⁶⁴, M. Shimojima¹⁰¹, M. Shiyakova⁶⁴, A. Shmeleva⁹⁵, M.J. Shochet³¹, D. Short¹¹⁹, S. Shrestha⁶³, E. Shulga⁹⁷, M.A. Shupe⁷, S. Shushkevich⁴², P. Sicho¹²⁶, O. Sidiropoulou¹⁵⁵, D. Sidorov¹¹³, A. Sidoti^{133a}, F. Siegert⁴⁴, Dj. Sijacki^{13a}, J. Silva^{125a,125d}, Y. Silver¹⁵⁴, D. Silverstein¹⁴⁴, S.B. Silverstein^{147a}, V. Simak¹²⁷, O. Simard⁵, Lj. Simic^{13a}, S. Simion¹¹⁶, E. Simioni⁸², B. Simmons⁷⁷, R. Simoniello^{90a,90b}, M. Simonyan³⁶, P. Sinervo¹⁵⁹, N.B. Sinev¹¹⁵, V. Sipica¹⁴², G. Siragusa¹⁷⁵, A. Sircar⁷⁸, A.N. Sisakyan^{64,*}, S.Yu. Sivoklokov⁹⁸, J. Sjölin^{147a,147b}, T.B. Sjurson¹⁴, H.P. Skottowe⁵⁷, K.Yu. Skovpen¹⁰⁸, P. Skubic¹¹², M. Slater¹⁸, T. Slavicek¹²⁷, K. Sliwa¹⁶², V. Smakhtin¹⁷³, B.H. Smart⁴⁶, L. Smestad¹⁴, S.Yu. Smirnov⁹⁷, Y. Smirnov⁹⁷, L.N. Smirnova^{98,af}, O. Smirnova⁸⁰, K.M. Smith⁵³, M. Smizanska⁷¹, K. Smolek¹²⁷, A.A. Snesarev⁹⁵, G. Snidero⁷⁵, S. Snyder²⁵, R. Sobie^{170,j}, F. Socher⁴⁴, A. Soffer¹⁵⁴, D.A. Soh^{152,ae}, C.A. Solans³⁰, M. Solar¹²⁷, J. Solc¹²⁷, E.Yu. Soldatov⁹⁷, U. Soldevila¹⁶⁸, A.A. Solodkov¹²⁹, A. Soloshenko⁶⁴, O.V. Solovyanov¹²⁹, V. Solovyev¹²², P. Sommer⁴⁸, H.Y. Song^{33b}, N. Soni¹, A. Sood¹⁵, A. Sopczak¹²⁷, B. Sopko¹²⁷, V. Sopko¹²⁷, V. Sorin¹², M. Sosebee⁸, R. Soualah^{165a,165c}, P. Soueid⁹⁴, A.M. Soukharev^{108,c}, D. South⁴², S. Spagnolo^{72a,72b}, F. Spanò⁷⁶, W.R. Spearman⁵⁷, F. Spettel¹⁰⁰, R. Spighi^{20a}, G. Spigo³⁰, L.A. Spiller⁸⁷, M. Spousta¹²⁸, T. Spreitzer¹⁵⁹, B. Spurlock⁸, R.D. St. Denis^{53,*}, S. Staerz⁴⁴, J. Stahlman¹²¹, R. Stamen^{58a}, S. Stamm¹⁶, E. Stanecka³⁹, R.W. Stanek⁶, C. Stanescu^{135a}, M. Stanescu-Bellu⁴², M.M. Stanitzki⁴², S. Stapnes¹¹⁸, E.A. Starchenko¹²⁹, J. Stark⁵⁵, P. Staroba¹²⁶, P. Starovoitov⁴², R. Staszewski³⁹, P. Stavina^{145a,*}, P. Steinberg²⁵, B. Stelzer¹⁴³, H.J. Stelzer³⁰, O. Stelzer-Chilton^{160a}, H. Stenzel⁵², S. Stern¹⁰⁰, G.A. Stewart⁵³, J.A. Stillings²¹, M.C. Stockton⁸⁶, M. Stoebe⁸⁶, G. Stoica^{26a}, P. Stolte⁵⁴, S. Stonjek¹⁰⁰, A.R. Stradling⁸, A. Straessner⁴⁴, M.E. Stramaglia¹⁷, J. Strandberg¹⁴⁸, S. Strandberg^{147a,147b}, A. Strandlie¹¹⁸, E. Strauss¹⁴⁴, M. Strauss¹¹², P. Strizenc^{145b}, R. Ströhmer¹⁷⁵, D.M. Strom¹¹⁵, R. Stroynowski⁴⁰, A. Strubig¹⁰⁵, S.A. Stucci¹⁷, B. Stugu¹⁴, N.A. Styles⁴², D. Su¹⁴⁴, J. Su¹²⁴, R. Subramaniam⁷⁸, A. Succurro¹², Y. Sugaya¹¹⁷, C. Suhr¹⁰⁷, M. Suk¹²⁷, V.V. Sulin⁹⁵, S. Sultansoy^{4c}, T. Sumida⁶⁷, S. Sun⁵⁷, X. Sun^{33a}, J.E. Sundermann⁴⁸, K. Suruliz¹⁴⁰, G. Susinno^{37a,37b}, M.R. Sutton¹⁵⁰, Y. Suzuki⁶⁵, M. Svatos¹²⁶, S. Swedish¹⁶⁹, M. Swiatlowski¹⁴⁴, I. Sykora^{145a}, T. Sykora¹²⁸, D. Ta⁸⁹, C. Taccini^{135a,135b}, K. Tackmann⁴², J. Taenzer¹⁵⁹, A. Taffard¹⁶⁴, R. Tahirout^{160a}, N. Taiblum¹⁵⁴, H. Takai²⁵, R. Takashima⁶⁸, H. Takeda⁶⁶, T. Takeshita¹⁴¹, Y. Takubo⁶⁵, M. Talby⁸⁴, A.A. Talyshev^{108,c}, J.Y.C. Tam¹⁷⁵, K.G. Tan⁸⁷, J. Tanaka¹⁵⁶, R. Tanaka¹¹⁶, S. Tanaka¹³², S. Tanaka⁶⁵, A.J. Tanasijczuk¹⁴³, B.B. Tannenwald¹¹⁰, N. Tannoury²¹, S. Tapprogge⁸², S. Tarem¹⁵³, F. Tarrade²⁹, G.F. Tartarelli^{90a}, P. Tas¹²⁸, M. Tasevsky¹²⁶, T. Tashiro⁶⁷, E. Tassi^{37a,37b}, A. Tavares Delgado^{125a,125b}, Y. Tayalati^{136d}, F.E. Taylor⁹³, G.N. Taylor⁸⁷, W. Taylor^{160b}, F.A. Teischinger³⁰, M. Teixeira Dias Castanheira⁷⁵, P. Teixeira-Dias⁷⁶, K.K. Temming⁴⁸, H. Ten Kate³⁰, P.K. Teng¹⁵², J.J. Teoh¹¹⁷, S. Terada⁶⁵, K. Terashi¹⁵⁶, J. Terron⁸¹, S. Terzo¹⁰⁰, M. Testa⁴⁷, R.J. Teuscher^{159,j}, J. Therhaag²¹, T. Theveneaux-Pelzer³⁴, J.P. Thomas¹⁸, J. Thomas-Wilsker⁷⁶, E.N. Thompson³⁵, P.D. Thompson¹⁸, P.D. Thompson¹⁵⁹, R.J. Thompson⁸³, A.S. Thompson⁵³, L.A. Thomsen³⁶, E. Thomson¹²¹, M. Thomson²⁸, W.M. Thong⁸⁷, R.P. Thun^{88,*}, F. Tian³⁵, M.J. Tibbetts¹⁵, V.O. Tikhomirov^{95,ag}, Yu.A. Tikhonov^{108,c}, S. Timoshenko⁹⁷, E. Tiouchichine⁸⁴, P. Tipton¹⁷⁷, S. Tisserant⁸⁴, T. Todorov⁵, S. Todorova-Nova¹²⁸, B. Toggerson⁷, J. Tojo⁶⁹, S. Tokár^{145a}, K. Tokushuku⁶⁵, K. Tollefson⁸⁹, E. Tolley⁵⁷, L. Tomlinson⁸³, M. Tomoto¹⁰², L. Tompkins³¹, K. Toms¹⁰⁴, N.D. Topilin⁶⁴, E. Torrence¹¹⁵, H. Torres¹⁴³, E. Torró Pastor¹⁶⁸, J. Toth^{84,ah}, F. Touchard⁸⁴, D.R. Tovey¹⁴⁰, H.L. Tran¹¹⁶, T. Trefzger¹⁷⁵, L. Tremblet³⁰, A. Tricoli³⁰, I.M. Trigger^{160a}, S. Trincaz-Duvold⁷⁹, M.F. Tripiana¹², W. Trischuk¹⁵⁹, B. Trocme⁵⁵, C. Troncon^{90a}, M. Trottier-McDonald¹⁵, M. Trovatelli^{135a,135b}, P. True⁸⁹, M. Trzebinski³⁹, A. Trzupek³⁹, C. Tsarouchas³⁰, J.C.-L. Tseng¹¹⁹, P.V. Tsiarshka⁹¹, D. Tsiou¹³⁷, G. Tsipolitis¹⁰, N. Tsirintanis⁹, S. Tsiskaridze¹², V. Tsiskaridze⁴⁸, E.G. Tskhadadze^{51a}, I.I. Tsukerman⁹⁶, V. Tsulaia¹⁵, S. Tsuno⁶⁵, D. Tsybychev¹⁴⁹, A. Tudorache^{26a}, V. Tudorache^{26a}, A.N. Tuna¹²¹, S.A. Tupputi^{20a,20b}, S. Turchikhin^{98,af}, D. Turecek¹²⁷, I. Turk Cakir^{4d}, R. Turra^{90a,90b}, P.M. Tuts³⁵, A. Tykhonov⁴⁹, M. Tylmad^{147a,147b}, M. Tyndel¹³⁰, K. Uchida²¹, I. Ueda¹⁵⁶, R. Ueno²⁹, M. Ughetto⁸⁴, M. Uglan¹⁴, M. Uhlenbrock²¹, F. Ukegawa¹⁶¹, G. Unal³⁰, A. Undrus²⁵, G. Unel¹⁶⁴, F.C. Ungaro⁴⁸, Y. Unno⁶⁵, C. Unverdorben⁹⁹, D. Urbaniec³⁵, P. Urquijo⁸⁷, G. Usai⁸, A. Usanova⁶¹, L. Vacavant⁸⁴, V. Vacek¹²⁷, B. Vachon⁸⁶, N. Valencic¹⁰⁶, S. Valentini^{20a,20b}, A. Valero¹⁶⁸, L. Valery³⁴, S. Valkar¹²⁸, E. Valladolid Gallego¹⁶⁸, S. Vallecorsa⁴⁹, J.A. Valls Ferrer¹⁶⁸, W. Van Den Wollenberg¹⁰⁶, P.C. Van Der Deijl¹⁰⁶, R. van der Geer¹⁰⁶, H. van der Graaf¹⁰⁶, R. Van Der Leeuw¹⁰⁶, D. van der Ster³⁰, N. van Eldik³⁰, P. van Gemmeren⁶, J. Van Nieuwkoop¹⁴³, I. van Vulpen¹⁰⁶, M.C. van Woerden³⁰, M. Vanadia^{133a,133b}, W. Vandelli³⁰, R. Vanguri¹²¹, A. Vaniachine⁶, P. Vankov⁴², F. Vannucci⁷⁹, G. Vardanyan¹⁷⁸, R. Vari^{133a}, E.W. Varnes⁷, T. Varol⁸⁵, D. Varouchas⁷⁹, A. Vartapetian⁸, K.E. Varvell¹⁵¹, F. Vazeille³⁴, T. Vazquez Schroeder⁵⁴, J. Veatch⁷, F. Veloso^{125a,125c}, S. Veneziano^{133a}, A. Ventura^{72a,72b}, D. Ventura⁸⁵, M. Venturi¹⁷⁰, N. Venturi¹⁵⁹, A. Venturini²³, V. Vercesi^{120a}, M. Verducci^{133a,133b}, W. Verkerke¹⁰⁶, J.C. Vermeulen¹⁰⁶, A. Vest⁴⁴, M.C. Vetterli^{143,e}, O. Viazlo⁸⁰, I. Vichou¹⁶⁶, T. Vickey^{146c,ai}, O.E. Vickey Boeriu^{146c}, G.H.A. Viehhauser¹¹⁹, S. Viel¹⁶⁹, R. Vigne³⁰, M. Villa^{20a,20b}, M. Villaplana Perez^{90a,90b}, E. Vilucchi⁴⁷, M.G. Vincker²⁹, V.B. Vinogradov⁶⁴, J. Virzi¹⁵, I. Vivarelli¹⁵⁰, F. Vives Vaque³,

S. Vlachos¹⁰, D. Vladioiu⁹⁹, M. Vlasak¹²⁷, A. Vogel²¹, M. Vogel^{32a}, P. Vokac¹²⁷, G. Volpi^{123a,123b}, M. Volpi⁸⁷, H. von der Schmitt¹⁰⁰, H. von Radziewski⁴⁸, E. von Toerne²¹, V. Vorobel¹²⁸, K. Vorobev⁹⁷, M. Vos¹⁶⁸, R. Voss³⁰, J.H. Vosseveld⁷³, N. Vranjes¹³⁷, M. Vranjes Milosavljevic^{13a}, V. Vrba¹²⁶, M. Vreeswijk¹⁰⁶, T. Vu Anh⁴⁸, R. Vuillermet³⁰, I. Vukotic³¹, Z. Vykydal¹²⁷, P. Wagner²¹, W. Wagner¹⁷⁶, H. Wahlberg⁷⁰, S. Wahrmond⁴⁴, J. Wakabayashi¹⁰², J. Walder⁷¹, R. Walker⁹⁹, W. Walkowiak¹⁴², R. Wall¹⁷⁷, P. Waller⁷³, B. Walsh¹⁷⁷, C. Wang^{152,aj}, C. Wang⁴⁵, F. Wang¹⁷⁴, H. Wang¹⁵, H. Wang⁴⁰, J. Wang⁴², J. Wang^{33a}, K. Wang⁸⁶, R. Wang¹⁰⁴, S.M. Wang¹⁵², T. Wang²¹, X. Wang¹⁷⁷, C. Wanotayaroj¹¹⁵, A. Warburton⁸⁶, C.P. Ward²⁸, D.R. Wardrope⁷⁷, M. Warsinsky⁴⁸, A. Washbrook⁴⁶, C. Wasicki⁴², P.M. Watkins¹⁸, A.T. Watson¹⁸, I.J. Watson¹⁵¹, M.F. Watson¹⁸, G. Watts¹³⁹, S. Watts⁸³, B.M. Waugh⁷⁷, S. Webb⁸³, M.S. Weber¹⁷, S.W. Weber¹⁷⁵, J.S. Webster³¹, A.R. Weidberg¹¹⁹, P. Weigell¹⁰⁰, B. Weinert⁶⁰, J. Weingarten⁵⁴, C. Weiser⁴⁸, H. Weits¹⁰⁶, P.S. Wells³⁰, T. Wenaus²⁵, D. Wendland¹⁶, Z. Weng^{152,ae}, T. Wengler³⁰, S. Wenig³⁰, N. Wermes²¹, M. Werner⁴⁸, P. Werner³⁰, M. Wessels^{38a}, J. Wetter¹⁶², K. Whalen²⁹, A. White⁸, M.J. White¹, R. White^{32b}, S. White^{123a,123b}, D. Whiteson¹⁶⁴, D. Wicke¹⁷⁶, F.J. Wickens¹³⁰, W. Wiedenmann¹⁷⁴, M. Wielers¹³⁰, P. Wienemann²¹, C. Wiglesworth³⁶, L.A.M. Wiik-Fuchs²¹, P.A. Wijeratne⁷⁷, A. Wildauer¹⁰⁰, M.A. Wildt^{42,ak}, H.G. Wilkens³⁰, J.Z. Will⁹⁹, H.H. Williams¹²¹, S. Williams²⁸, C. Willis⁸⁹, S. Willocq⁸⁵, A. Wilson⁸⁸, J.A. Wilson¹⁸, I. Wingerter-Seez⁵, F. Winklmeier¹¹⁵, B.T. Winter²¹, M. Wittgen¹⁴⁴, T. Wittig⁴³, J. Wittkowski⁹⁹, S.J. Wollstadt⁸², M.W. Wolter³⁹, H. Wolters^{125a,125c}, B.K. Wosiek³⁹, J. Wotschack³⁰, M.J. Woudstra⁸³, K.W. Wozniak³⁹, M. Wright⁵³, M. Wu⁵⁵, S.L. Wu¹⁷⁴, X. Wu⁴⁹, Y. Wu⁸⁸, E. Wulf³⁵, T.R. Wyatt⁸³, B.M. Wynne⁴⁶, S. Xella³⁶, M. Xiao¹³⁷, D. Xu^{33a}, L. Xu^{33b,al}, B. Yabsley¹⁵¹, S. Yacoub^{146b,am}, R. Yakabe⁶⁶, M. Yamada⁶⁵, H. Yamaguchi¹⁵⁶, Y. Yamaguchi¹¹⁷, A. Yamamoto⁶⁵, K. Yamamoto⁶³, S. Yamamoto¹⁵⁶, T. Yamamura¹⁵⁶, T. Yamanaka¹⁵⁶, K. Yamauchi¹⁰², Y. Yamazaki⁶⁶, Z. Yan²², H. Yang^{33e}, H. Yang¹⁷⁴, U.K. Yang⁸³, Y. Yang¹¹⁰, S. Yanush⁹², L. Yao^{33a}, W.-M. Yao¹⁵, Y. Yasu⁶⁵, E. Yatsenko⁴², K.H. Yau Wong²¹, J. Ye⁴⁰, S. Ye²⁵, I. Yeletsikh⁶⁴, A.L. Yen⁵⁷, E. Yildirim⁴², M. Yilmaz^{4b}, R. Yoosoofofiya¹²⁴, K. Yorita¹⁷², R. Yoshida⁶, K. Yoshihara¹⁵⁶, C. Young¹⁴⁴, C.J.S. Young³⁰, S. Youssef²², D.R. Yu¹⁵, J. Yu⁸, J.M. Yu⁸⁸, J. Yu¹¹³, L. Yuan⁶⁶, A. Yurkewicz¹⁰⁷, I. Yusuff^{28,an}, B. Zabinski³⁹, R. Zaidan⁶², A.M. Zaitsev^{129,aa}, A. Zaman¹⁴⁹, S. Zambito²³, L. Zanello^{133a,133b}, D. Zanzi⁸⁷, C. Zeitnitz¹⁷⁶, M. Zeman¹²⁷, A. Zemla^{38a}, K. Zengel²³, O. Zenin¹²⁹, T. Ženiš^{145a}, D. Zerwas¹¹⁶, G. Zevi della Porta⁵⁷, D. Zhang⁸⁸, F. Zhang¹⁷⁴, H. Zhang⁸⁹, J. Zhang⁶, L. Zhang¹⁵², X. Zhang^{33d}, Z. Zhang¹¹⁶, Z. Zhao^{33b}, A. Zhemchugov⁶⁴, J. Zhong¹¹⁹, B. Zhou⁸⁸, L. Zhou³⁵, N. Zhou¹⁶⁴, C.G. Zhu^{33d}, H. Zhu^{33a}, J. Zhu⁸⁸, Y. Zhu^{33b}, X. Zhuang^{33a}, K. Zhukov⁹⁵, A. Zibell¹⁷⁵, D. Zieminska⁶⁰, N.I. Zimine⁶⁴, C. Zimmermann⁸², R. Zimmermann²¹, S. Zimmermann²¹, S. Zimmermann⁴⁸, Z. Zinonos⁵⁴, M. Ziolkowski¹⁴², G. Zobernig¹⁷⁴, A. Zoccoli^{20a,20b}, M. zur Nedden¹⁶, G. Zurzolo^{103a,103b}, V. Zutshi¹⁰⁷, L. Zwalinski³⁰.

¹ Department of Physics, University of Adelaide, Adelaide, Australia

² Physics Department, SUNY Albany, Albany NY, United States of America

³ Department of Physics, University of Alberta, Edmonton AB, Canada

⁴ (a) Department of Physics, Ankara University, Ankara; (b) Department of Physics, Gazi University, Ankara; (c) Division of Physics, TOBB University of Economics and Technology, Ankara; (d) Turkish Atomic Energy Authority, Ankara, Turkey

⁵ LAPP, CNRS/IN2P3 and Université de Savoie, Annecy-le-Vieux, France

⁶ High Energy Physics Division, Argonne National Laboratory, Argonne IL, United States of America

⁷ Department of Physics, University of Arizona, Tucson AZ, United States of America

⁸ Department of Physics, The University of Texas at Arlington, Arlington TX, United States of America

⁹ Physics Department, University of Athens, Athens, Greece

¹⁰ Physics Department, National Technical University of Athens, Zografou, Greece

¹¹ Institute of Physics, Azerbaijan Academy of Sciences, Baku, Azerbaijan

¹² Institut de Física d'Altes Energies and Departament de Física de la Universitat Autònoma de Barcelona, Barcelona, Spain

¹³ (a) Institute of Physics, University of Belgrade, Belgrade; (b) Vinca Institute of Nuclear Sciences, University of Belgrade, Belgrade, Serbia

¹⁴ Department for Physics and Technology, University of Bergen, Bergen, Norway

¹⁵ Physics Division, Lawrence Berkeley National Laboratory and University of California, Berkeley CA, United States of America

¹⁶ Department of Physics, Humboldt University, Berlin, Germany

¹⁷ Albert Einstein Center for Fundamental Physics and Laboratory for High Energy Physics, University of Bern, Bern, Switzerland

¹⁸ School of Physics and Astronomy, University of Birmingham, Birmingham, United Kingdom

¹⁹ (a) Department of Physics, Bogazici University, Istanbul; (b) Department of Physics, Dogus University, Istanbul; (c) Department of Physics Engineering, Gaziantep University, Gaziantep, Turkey

²⁰ (a) INFN Sezione di Bologna; (b) Dipartimento di Fisica e Astronomia, Università di Bologna, Bologna, Italy

²¹ Physikalisches Institut, University of Bonn, Bonn, Germany

²² Department of Physics, Boston University, Boston MA, United States of America

²³ Department of Physics, Brandeis University, Waltham MA, United States of America

²⁴ (a) Universidade Federal do Rio De Janeiro COPPE/EE/IF, Rio de Janeiro; (b) Federal University of Juiz de Fora (UFJF), Juiz de Fora; (c) Federal University of Sao Joao del Rei (UFSJ), Sao Joao del Rei; (d) Instituto de Fisica, Universidade de Sao Paulo, Sao Paulo, Brazil

- ²⁵ Physics Department, Brookhaven National Laboratory, Upton NY, United States of America
- ²⁶ ^(a) National Institute of Physics and Nuclear Engineering, Bucharest; ^(b) National Institute for Research and Development of Isotopic and Molecular Technologies, Physics Department, Cluj Napoca; ^(c) University Politehnica Bucharest, Bucharest; ^(d) West University in Timisoara, Timisoara, Romania
- ²⁷ Departamento de Física, Universidad de Buenos Aires, Buenos Aires, Argentina
- ²⁸ Cavendish Laboratory, University of Cambridge, Cambridge, United Kingdom
- ²⁹ Department of Physics, Carleton University, Ottawa ON, Canada
- ³⁰ CERN, Geneva, Switzerland
- ³¹ Enrico Fermi Institute, University of Chicago, Chicago IL, United States of America
- ³² ^(a) Departamento de Física, Pontificia Universidad Católica de Chile, Santiago; ^(b) Departamento de Física, Universidad Técnica Federico Santa María, Valparaíso, Chile
- ³³ ^(a) Institute of High Energy Physics, Chinese Academy of Sciences, Beijing; ^(b) Department of Modern Physics, University of Science and Technology of China, Anhui; ^(c) Department of Physics, Nanjing University, Jiangsu; ^(d) School of Physics, Shandong University, Shandong; ^(e) Physics Department, Shanghai Jiao Tong University, Shanghai, China
- ³⁴ Laboratoire de Physique Corpusculaire, Clermont Université and Université Blaise Pascal and CNRS/IN2P3, Clermont-Ferrand, France
- ³⁵ Nevis Laboratory, Columbia University, Irvington NY, United States of America
- ³⁶ Niels Bohr Institute, University of Copenhagen, Kobenhavn, Denmark
- ³⁷ ^(a) INFN Gruppo Collegato di Cosenza, Laboratori Nazionali di Frascati; ^(b) Dipartimento di Fisica, Università della Calabria, Rende, Italy
- ³⁸ ^(a) AGH University of Science and Technology, Faculty of Physics and Applied Computer Science, Krakow; ^(b) Marian Smoluchowski Institute of Physics, Jagiellonian University, Krakow, Poland
- ³⁹ The Henryk Niewodniczanski Institute of Nuclear Physics, Polish Academy of Sciences, Krakow, Poland
- ⁴⁰ Physics Department, Southern Methodist University, Dallas TX, United States of America
- ⁴¹ Physics Department, University of Texas at Dallas, Richardson TX, United States of America
- ⁴² DESY, Hamburg and Zeuthen, Germany
- ⁴³ Institut für Experimentelle Physik IV, Technische Universität Dortmund, Dortmund, Germany
- ⁴⁴ Institut für Kern- und Teilchenphysik, Technische Universität Dresden, Dresden, Germany
- ⁴⁵ Department of Physics, Duke University, Durham NC, United States of America
- ⁴⁶ SUPA - School of Physics and Astronomy, University of Edinburgh, Edinburgh, United Kingdom
- ⁴⁷ INFN Laboratori Nazionali di Frascati, Frascati, Italy
- ⁴⁸ Fakultät für Mathematik und Physik, Albert-Ludwigs-Universität, Freiburg, Germany
- ⁴⁹ Section de Physique, Université de Genève, Geneva, Switzerland
- ⁵⁰ ^(a) INFN Sezione di Genova; ^(b) Dipartimento di Fisica, Università di Genova, Genova, Italy
- ⁵¹ ^(a) E. Andronikashvili Institute of Physics, Iv. Javakishvili Tbilisi State University, Tbilisi; ^(b) High Energy Physics Institute, Tbilisi State University, Tbilisi, Georgia
- ⁵² II Physikalisches Institut, Justus-Liebig-Universität Giessen, Giessen, Germany
- ⁵³ SUPA - School of Physics and Astronomy, University of Glasgow, Glasgow, United Kingdom
- ⁵⁴ II Physikalisches Institut, Georg-August-Universität, Göttingen, Germany
- ⁵⁵ Laboratoire de Physique Subatomique et de Cosmologie, Université Grenoble-Alpes, CNRS/IN2P3, Grenoble, France
- ⁵⁶ Department of Physics, Hampton University, Hampton VA, United States of America
- ⁵⁷ Laboratory for Particle Physics and Cosmology, Harvard University, Cambridge MA, United States of America
- ⁵⁸ ^(a) Kirchhoff-Institut für Physik, Ruprecht-Karls-Universität Heidelberg, Heidelberg; ^(b) Physikalisches Institut, Ruprecht-Karls-Universität Heidelberg, Heidelberg; ^(c) ZITI Institut für technische Informatik, Ruprecht-Karls-Universität Heidelberg, Mannheim, Germany
- ⁵⁹ Faculty of Applied Information Science, Hiroshima Institute of Technology, Hiroshima, Japan
- ⁶⁰ Department of Physics, Indiana University, Bloomington IN, United States of America
- ⁶¹ Institut für Astro- und Teilchenphysik, Leopold-Franzens-Universität, Innsbruck, Austria
- ⁶² University of Iowa, Iowa City IA, United States of America
- ⁶³ Department of Physics and Astronomy, Iowa State University, Ames IA, United States of America
- ⁶⁴ Joint Institute for Nuclear Research, JINR Dubna, Dubna, Russia
- ⁶⁵ KEK, High Energy Accelerator Research Organization, Tsukuba, Japan
- ⁶⁶ Graduate School of Science, Kobe University, Kobe, Japan
- ⁶⁷ Faculty of Science, Kyoto University, Kyoto, Japan
- ⁶⁸ Kyoto University of Education, Kyoto, Japan
- ⁶⁹ Department of Physics, Kyushu University, Fukuoka, Japan
- ⁷⁰ Instituto de Física La Plata, Universidad Nacional de La Plata and CONICET, La Plata, Argentina

⁷¹ Physics Department, Lancaster University, Lancaster, United Kingdom
⁷² ^(a) INFN Sezione di Lecce; ^(b) Dipartimento di Matematica e Fisica, Università del Salento, Lecce, Italy
⁷³ Oliver Lodge Laboratory, University of Liverpool, Liverpool, United Kingdom
⁷⁴ Department of Physics, Jožef Stefan Institute and University of Ljubljana, Ljubljana, Slovenia
⁷⁵ School of Physics and Astronomy, Queen Mary University of London, London, United Kingdom
⁷⁶ Department of Physics, Royal Holloway University of London, Surrey, United Kingdom
⁷⁷ Department of Physics and Astronomy, University College London, London, United Kingdom
⁷⁸ Louisiana Tech University, Ruston LA, United States of America
⁷⁹ Laboratoire de Physique Nucléaire et de Hautes Energies, UPMC and Université Paris-Diderot and CNRS/IN2P3, Paris, France
⁸⁰ Fysiska institutionen, Lunds universitet, Lund, Sweden
⁸¹ Departamento de Física Teórica C-15, Universidad Autónoma de Madrid, Madrid, Spain
⁸² Institut für Physik, Universität Mainz, Mainz, Germany
⁸³ School of Physics and Astronomy, University of Manchester, Manchester, United Kingdom
⁸⁴ CPPM, Aix-Marseille Université and CNRS/IN2P3, Marseille, France
⁸⁵ Department of Physics, University of Massachusetts, Amherst MA, United States of America
⁸⁶ Department of Physics, McGill University, Montreal QC, Canada
⁸⁷ School of Physics, University of Melbourne, Victoria, Australia
⁸⁸ Department of Physics, The University of Michigan, Ann Arbor MI, United States of America
⁸⁹ Department of Physics and Astronomy, Michigan State University, East Lansing MI, United States of America
⁹⁰ ^(a) INFN Sezione di Milano; ^(b) Dipartimento di Fisica, Università di Milano, Milano, Italy
⁹¹ B.I. Stepanov Institute of Physics, National Academy of Sciences of Belarus, Minsk, Republic of Belarus
⁹² National Scientific and Educational Centre for Particle and High Energy Physics, Minsk, Republic of Belarus
⁹³ Department of Physics, Massachusetts Institute of Technology, Cambridge MA, United States of America
⁹⁴ Group of Particle Physics, University of Montreal, Montreal QC, Canada
⁹⁵ P.N. Lebedev Institute of Physics, Academy of Sciences, Moscow, Russia
⁹⁶ Institute for Theoretical and Experimental Physics (ITEP), Moscow, Russia
⁹⁷ Moscow Engineering and Physics Institute (MEPhI), Moscow, Russia
⁹⁸ D.V.Skobel'syn Institute of Nuclear Physics, M.V.Lomonosov Moscow State University, Moscow, Russia
⁹⁹ Fakultät für Physik, Ludwig-Maximilians-Universität München, München, Germany
¹⁰⁰ Max-Planck-Institut für Physik (Werner-Heisenberg-Institut), München, Germany
¹⁰¹ Nagasaki Institute of Applied Science, Nagasaki, Japan
¹⁰² Graduate School of Science and Kobayashi-Maskawa Institute, Nagoya University, Nagoya, Japan
¹⁰³ ^(a) INFN Sezione di Napoli; ^(b) Dipartimento di Fisica, Università di Napoli, Napoli, Italy
¹⁰⁴ Department of Physics and Astronomy, University of New Mexico, Albuquerque NM, United States of America
¹⁰⁵ Institute for Mathematics, Astrophysics and Particle Physics, Radboud University Nijmegen/Nikhef, Nijmegen, Netherlands
¹⁰⁶ Nikhef National Institute for Subatomic Physics and University of Amsterdam, Amsterdam, Netherlands
¹⁰⁷ Department of Physics, Northern Illinois University, DeKalb IL, United States of America
¹⁰⁸ Budker Institute of Nuclear Physics, SB RAS, Novosibirsk, Russia
¹⁰⁹ Department of Physics, New York University, New York NY, United States of America
¹¹⁰ Ohio State University, Columbus OH, United States of America
¹¹¹ Faculty of Science, Okayama University, Okayama, Japan
¹¹² Homer L. Dodge Department of Physics and Astronomy, University of Oklahoma, Norman OK, United States of America
¹¹³ Department of Physics, Oklahoma State University, Stillwater OK, United States of America
¹¹⁴ Palacký University, RCPTM, Olomouc, Czech Republic
¹¹⁵ Center for High Energy Physics, University of Oregon, Eugene OR, United States of America
¹¹⁶ LAL, Université Paris-Sud and CNRS/IN2P3, Orsay, France
¹¹⁷ Graduate School of Science, Osaka University, Osaka, Japan
¹¹⁸ Department of Physics, University of Oslo, Oslo, Norway
¹¹⁹ Department of Physics, Oxford University, Oxford, United Kingdom
¹²⁰ ^(a) INFN Sezione di Pavia; ^(b) Dipartimento di Fisica, Università di Pavia, Pavia, Italy
¹²¹ Department of Physics, University of Pennsylvania, Philadelphia PA, United States of America
¹²² Petersburg Nuclear Physics Institute, Gatchina, Russia
¹²³ ^(a) INFN Sezione di Pisa; ^(b) Dipartimento di Fisica E. Fermi, Università di Pisa, Pisa, Italy
¹²⁴ Department of Physics and Astronomy, University of Pittsburgh, Pittsburgh PA, United States of America
¹²⁵ ^(a) Laboratório de Instrumentação e Física Experimental de Partículas - LIP, Lisboa; ^(b) Faculdade de Ciências, Universidade de Lisboa, Lisboa; ^(c) Department of Physics, University of Coimbra, Coimbra; ^(d) Centro de Física Nuclear da Universidade de Lisboa, Lisboa; ^(e) Departamento de Física, Universidade do Minho, Braga; ^(f) Departamento de Física Teórica y del Cosmos and

- CAFPE, Universidad de Granada, Granada (Spain); ^(g) Dep Fisica and CEFITEC of Faculdade de Ciencias e Tecnologia, Universidade Nova de Lisboa, Caparica, Portugal
- ¹²⁶ Institute of Physics, Academy of Sciences of the Czech Republic, Praha, Czech Republic
- ¹²⁷ Czech Technical University in Prague, Praha, Czech Republic
- ¹²⁸ Faculty of Mathematics and Physics, Charles University in Prague, Praha, Czech Republic
- ¹²⁹ State Research Center Institute for High Energy Physics, Protvino, Russia
- ¹³⁰ Particle Physics Department, Rutherford Appleton Laboratory, Didcot, United Kingdom
- ¹³¹ Physics Department, University of Regina, Regina SK, Canada
- ¹³² Ritsumeikan University, Kusatsu, Shiga, Japan
- ¹³³ ^(a) INFN Sezione di Roma; ^(b) Dipartimento di Fisica, Sapienza Università di Roma, Roma, Italy
- ¹³⁴ ^(a) INFN Sezione di Roma Tor Vergata; ^(b) Dipartimento di Fisica, Università di Roma Tor Vergata, Roma, Italy
- ¹³⁵ ^(a) INFN Sezione di Roma Tre; ^(b) Dipartimento di Matematica e Fisica, Università Roma Tre, Roma, Italy
- ¹³⁶ ^(a) Faculté des Sciences Ain Chock, Réseau Universitaire de Physique des Hautes Energies - Université Hassan II, Casablanca; ^(b) Centre National de l'Energie des Sciences Techniques Nucleaires, Rabat; ^(c) Faculté des Sciences Semlalia, Université Cadi Ayyad, LPHEA-Marrakech; ^(d) Faculté des Sciences, Université Mohamed Premier and LTPM, Oujda; ^(e) Faculté des sciences, Université Mohammed V-Agdal, Rabat, Morocco
- ¹³⁷ DSM/IRFU (Institut de Recherches sur les Lois Fondamentales de l'Univers), CEA Saclay (Commissariat à l'Energie Atomique et aux Energies Alternatives), Gif-sur-Yvette, France
- ¹³⁸ Santa Cruz Institute for Particle Physics, University of California Santa Cruz, Santa Cruz CA, United States of America
- ¹³⁹ Department of Physics, University of Washington, Seattle WA, United States of America
- ¹⁴⁰ Department of Physics and Astronomy, University of Sheffield, Sheffield, United Kingdom
- ¹⁴¹ Department of Physics, Shinshu University, Nagano, Japan
- ¹⁴² Fachbereich Physik, Universität Siegen, Siegen, Germany
- ¹⁴³ Department of Physics, Simon Fraser University, Burnaby BC, Canada
- ¹⁴⁴ SLAC National Accelerator Laboratory, Stanford CA, United States of America
- ¹⁴⁵ ^(a) Faculty of Mathematics, Physics & Informatics, Comenius University, Bratislava; ^(b) Department of Subnuclear Physics, Institute of Experimental Physics of the Slovak Academy of Sciences, Kosice, Slovak Republic
- ¹⁴⁶ ^(a) Department of Physics, University of Cape Town, Cape Town; ^(b) Department of Physics, University of Johannesburg, Johannesburg; ^(c) School of Physics, University of the Witwatersrand, Johannesburg, South Africa
- ¹⁴⁷ ^(a) Department of Physics, Stockholm University; ^(b) The Oskar Klein Centre, Stockholm, Sweden
- ¹⁴⁸ Physics Department, Royal Institute of Technology, Stockholm, Sweden
- ¹⁴⁹ Departments of Physics & Astronomy and Chemistry, Stony Brook University, Stony Brook NY, United States of America
- ¹⁵⁰ Department of Physics and Astronomy, University of Sussex, Brighton, United Kingdom
- ¹⁵¹ School of Physics, University of Sydney, Sydney, Australia
- ¹⁵² Institute of Physics, Academia Sinica, Taipei, Taiwan
- ¹⁵³ Department of Physics, Technion: Israel Institute of Technology, Haifa, Israel
- ¹⁵⁴ Raymond and Beverly Sackler School of Physics and Astronomy, Tel Aviv University, Tel Aviv, Israel
- ¹⁵⁵ Department of Physics, Aristotle University of Thessaloniki, Thessaloniki, Greece
- ¹⁵⁶ International Center for Elementary Particle Physics and Department of Physics, The University of Tokyo, Tokyo, Japan
- ¹⁵⁷ Graduate School of Science and Technology, Tokyo Metropolitan University, Tokyo, Japan
- ¹⁵⁸ Department of Physics, Tokyo Institute of Technology, Tokyo, Japan
- ¹⁵⁹ Department of Physics, University of Toronto, Toronto ON, Canada
- ¹⁶⁰ ^(a) TRIUMF, Vancouver BC; ^(b) Department of Physics and Astronomy, York University, Toronto ON, Canada
- ¹⁶¹ Faculty of Pure and Applied Sciences, University of Tsukuba, Tsukuba, Japan
- ¹⁶² Department of Physics and Astronomy, Tufts University, Medford MA, United States of America
- ¹⁶³ Centro de Investigaciones, Universidad Antonio Narino, Bogota, Colombia
- ¹⁶⁴ Department of Physics and Astronomy, University of California Irvine, Irvine CA, United States of America
- ¹⁶⁵ ^(a) INFN Gruppo Collegato di Udine, Sezione di Trieste, Udine; ^(b) ICTP, Trieste; ^(c) Dipartimento di Chimica, Fisica e Ambiente, Università di Udine, Udine, Italy
- ¹⁶⁶ Department of Physics, University of Illinois, Urbana IL, United States of America
- ¹⁶⁷ Department of Physics and Astronomy, University of Uppsala, Uppsala, Sweden
- ¹⁶⁸ Instituto de Física Corpuscular (IFIC) and Departamento de Física Atómica, Molecular y Nuclear and Departamento de Ingeniería Electrónica and Instituto de Microelectrónica de Barcelona (IMB-CNM), University of Valencia and CSIC, Valencia, Spain
- ¹⁶⁹ Department of Physics, University of British Columbia, Vancouver BC, Canada
- ¹⁷⁰ Department of Physics and Astronomy, University of Victoria, Victoria BC, Canada
- ¹⁷¹ Department of Physics, University of Warwick, Coventry, United Kingdom

- ¹⁷² Waseda University, Tokyo, Japan
- ¹⁷³ Department of Particle Physics, The Weizmann Institute of Science, Rehovot, Israel
- ¹⁷⁴ Department of Physics, University of Wisconsin, Madison WI, United States of America
- ¹⁷⁵ Fakultät für Physik und Astronomie, Julius-Maximilians-Universität, Würzburg, Germany
- ¹⁷⁶ Fachbereich C Physik, Bergische Universität Wuppertal, Wuppertal, Germany
- ¹⁷⁷ Department of Physics, Yale University, New Haven CT, United States of America
- ¹⁷⁸ Yerevan Physics Institute, Yerevan, Armenia
- ¹⁷⁹ Centre de Calcul de l'Institut National de Physique Nucléaire et de Physique des Particules (IN2P3), Villeurbanne, France
- ^a Also at Department of Physics, King's College London, London, United Kingdom
- ^b Also at Institute of Physics, Azerbaijan Academy of Sciences, Baku, Azerbaijan
- ^c Also at Novosibirsk State University, Novosibirsk, Russia
- ^d Also at Particle Physics Department, Rutherford Appleton Laboratory, Didcot, United Kingdom
- ^e Also at TRIUMF, Vancouver BC, Canada
- ^f Also at Department of Physics, California State University, Fresno CA, United States of America
- ^g Also at Tomsk State University, Tomsk, Russia
- ^h Also at CPPM, Aix-Marseille Université and CNRS/IN2P3, Marseille, France
- ⁱ Also at Università di Napoli Parthenope, Napoli, Italy
- ^j Also at Institute of Particle Physics (IPP), Canada
- ^k Also at Department of Physics, St. Petersburg State Polytechnical University, St. Petersburg, Russia
- ^l Also at Chinese University of Hong Kong, China
- ^m Also at Department of Financial and Management Engineering, University of the Aegean, Chios, Greece
- ⁿ Also at Louisiana Tech University, Ruston LA, United States of America
- ^o Also at Institutio Catalana de Recerca i Estudis Avancats, ICREA, Barcelona, Spain
- ^p Also at Department of Physics, The University of Texas at Austin, Austin TX, United States of America
- ^q Also at Institute of Theoretical Physics, Iia State University, Tbilisi, Georgia
- ^r Also at CERN, Geneva, Switzerland
- ^s Also at O Chadai Academic Production, Ochanomizu University, Tokyo, Japan
- ^t Also at Manhattan College, New York NY, United States of America
- ^u Also at Institute of Physics, Academia Sinica, Taipei, Taiwan
- ^v Also at LAL, Université Paris-Sud and CNRS/IN2P3, Orsay, France
- ^w Also at Academia Sinica Grid Computing, Institute of Physics, Academia Sinica, Taipei, Taiwan
- ^x Also at Laboratoire de Physique Nucléaire et de Hautes Energies, UPMC and Université Paris-Diderot and CNRS/IN2P3, Paris, France
- ^y Also at School of Physical Sciences, National Institute of Science Education and Research, Bhubaneswar, India
- ^z Also at Dipartimento di Fisica, Sapienza Università di Roma, Roma, Italy
- ^{aa} Also at Moscow Institute of Physics and Technology State University, Dolgoprudny, Russia
- ^{ab} Also at Section de Physique, Université de Genève, Geneva, Switzerland
- ^{ac} Also at International School for Advanced Studies (SISSA), Trieste, Italy
- ^{ad} Also at Department of Physics and Astronomy, University of South Carolina, Columbia SC, United States of America
- ^{ae} Also at School of Physics and Engineering, Sun Yat-sen University, Guangzhou, China
- ^{af} Also at Faculty of Physics, M.V.Lomonosov Moscow State University, Moscow, Russia
- ^{ag} Also at Moscow Engineering and Physics Institute (MEPhI), Moscow, Russia
- ^{ah} Also at Institute for Particle and Nuclear Physics, Wigner Research Centre for Physics, Budapest, Hungary
- ^{ai} Also at Department of Physics, Oxford University, Oxford, United Kingdom
- ^{aj} Also at Department of Physics, Nanjing University, Jiangsu, China
- ^{ak} Also at Institut für Experimentalphysik, Universität Hamburg, Hamburg, Germany
- ^{al} Also at Department of Physics, The University of Michigan, Ann Arbor MI, United States of America
- ^{am} Also at Discipline of Physics, University of KwaZulu-Natal, Durban, South Africa
- ^{an} Also at University of Malaya, Department of Physics, Kuala Lumpur, Malaysia
- * Deceased