



The Compact Muon Solenoid Experiment  
**Conference Report**

Mailing address: CMS CERN, CH-1211 GENEVA 23, Switzerland



24 October 2009 (v2, 03 November 2009)

# Experimental Studies Towards a DC-DC Conversion Powering Scheme for the CMS Silicon Strip Tracker at SLHC

K. Klein, L. Feld, R. Jussen, W. Karpinski, J. Merz, J. Sammet

1. Physikalisches Institut B, RWTH Aachen University, 52074 Aachen, Germany

## Abstract

The upgrade of the CMS silicon tracker for the Super-LHC presents many challenges. The distribution of power to the tracker is considered particularly difficult, as the tracker power consumption is expected to be similar to or higher than today, while the operating voltage will decrease and power cables cannot be exchanged or added. The CMS tracker has adopted parallel powering with DC-DC conversion as the baseline solution to the powering problem. In this paper, experimental studies of such a DC-DC conversion powering scheme are presented, including system test measurements with custom DC-DC converters and current strip tracker structures, studies of the detector susceptibility to conductive noise, and simulations of the effect of novel powering schemes on the strip tracker material budget.

Presented at *TWEPP09: Topical Workshop on Electronics for Particle Physics*

## I. INTRODUCTION

The Super-LHC (SLHC) is a proposed luminosity-upgrade of the LHC. It is currently foreseen to increase the peak luminosity in two phases: by a factor of two with respect to the nominal LHC peak luminosity four to five years after the start-up of the LHC (phase-1), and by a further factor of five ten years after LHC start-up (phase-2). This would lead to a drastic increase in the number of particles per event in the CMS tracker [1], from about 1 000 at design luminosity to 15 000-20 000 at SLHC phase-2. As a consequence, for phase-2 the sensitive cell size in the strip tracker must be reduced to limit the detector occupancy, and tracking information must be delivered to, and used by, the first level trigger, to keep the level-1 trigger rate at its current level [2]. Due to the increase in the number of readout channels and the need for fast, complex digital electronics it is unlikely that the strip tracker power consumption will decrease significantly compared to the current value of 34 kW. The use of smaller feature-size CMOS processes with lower operating voltages will lead to larger supply currents even for a constant power budget. While the long power cables that connect the detector to the power supply units are installed in a way that virtually excludes their replacement during the lifetime of the experiment, there is a strong desire to reduce the material inside the sensitive detector volume, in order to improve the performance of the upgraded detector.

Following a review process, at the beginning of 2009 the CMS Tracker Collaboration chose parallel powering with DC-DC conversion as its future powering scheme. Serial powering [3] serves as back-up solution. Reverting to the back-up must remain possible until the feasibility of a DC-DC conversion powering scheme has been proven.

DC-DC converters will be used to convert a high input voltage  $V_{in}$  to the operating voltage  $V_{out}$  required by the detector modules (likely to be 1.2 V or lower). The actual required conversion ratio, here defined as  $r = V_{in}/V_{out}$ , depends on the layout of the future tracker. Conversion ratios as low as two might be sufficient for the upgraded pixel detector at phase-1, whereas a factor of ten might be required for the track trigger layers at phase-2. Resistive power losses in supply cables are reduced by  $(1/\epsilon \cdot r)^2$ , where  $\epsilon$  denotes the converter efficiency.

The buck converter [4] is the simplest inductor-based step-down converter. With relatively few components and the ability to deliver currents of several Amperes at efficiencies of 70-80 %, even for high conversion ratios, this DC-DC converter type is currently the best candidate for use in the CMS tracker. However, several challenges exist on the system level and must be addressed: switching with frequencies in the MHz range might inject conductive noise into the detector system; air-core inductors, needed because of saturation of ferrite cores in the 3.8 T magnetic field of CMS, might radiate electro-magnetic noise; the converter's size and mass must be reduced as much as possible, without degrading its electrical performance. A low efficiency would cancel out the advantages of DC-DC conversion.

## II. DC-DC CONVERTER DEVELOPMENT

### A. The AC2 Buck Converters

Building on our previous experience reported in [5], we have developed DC-DC buck converters based on a commercial, not radiation-hard buck converter chip. The aim was to develop a small, light and low noise device as a proof-of-principle.

The basic schematics of the 2-layer PCB is shown in Fig. 1. The buck converter chip EQ5382D from Enpirion [6] delivers currents up to 0.8 A, up to a recommended maximal input voltage of 5.5 V, at a switching frequency of 4 MHz. Two types of custom toroidal air-core inductors with a diameter of 6 mm are used: the *Mini Toroid* with a height of 7 mm, an inductance of  $\approx 600$  nH and a DC-resistance of 80-100 m $\Omega$ , and the *Tiny Toroid* with a height of 4 mm, an inductance of  $\approx 220$  nH and a DC-resistance of 40-50 m $\Omega$  (Fig. 2). Filter capacitors are implemented at the input and output of the converter. Different types of capacitors have been tested: standard capacitors are implemented on the *AC2-StandardC* board (Fig. 2, left), low-ESL capacitors in reverse geometry on the board *AC2-ReverseC*, and low-ESL InterDigitated Capacitors (IDC) with eight terminals on variant *AC2-IDC*. Our buck converters are 12 mm wide, 19/25/27 mm long (StandardC/ReverseC/IDC; without connectors) and 10 mm high. The weight amounts to about 1 g.

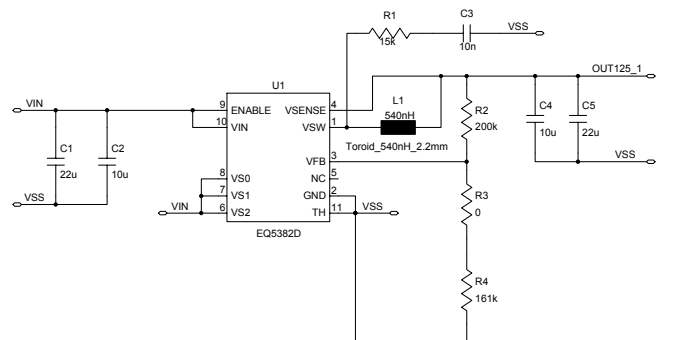

Figure 1: Schematics of the AC2-StandardC PCB.

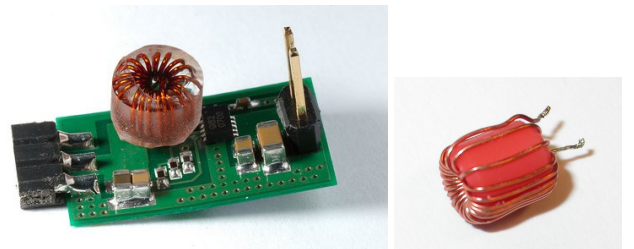

Figure 2: Left: buck converter of type AC2-StandardC, with a toroid coil of type Tiny Toroid. Right: Mini Toroid. Details are given in the text.

## B. Material Budget

One of the motivations for novel powering schemes is the possibility to reduce the material inside the sensitive tracker volume. To understand in a quantitative way the gain that can be expected, simulation studies have been performed within the CMS software framework, CMSSW, based on GEANT4 [7]. The geometry implementation of the current strip tracker has been used as a starting point, and only components relevant for power provision have been added or changed.

One AC2-StandardC converter with Mini Toroid has been “placed” close to the front-end hybrid for each silicon strip module. All components have been modelled in the software as realistically as possible, taking into account their size and material composition: the PCB with its copper layers; capacitors and resistors; the chip; the toroid coil (shielded) and the connectors. In Fig. 3, left hand-side, the contribution of the buck converters in the Tracker End Caps (TEC) is shown in units of radiation lengths,  $x/X_0$ , versus the pseudorapidity. The material contributed by the converters amounts to about 10 % of the material of the silicon strip modules.

When DC-DC converters are used less copper is required in power cables and motherboards, as the input currents are reduced by the conversion ratio. A conversion ratio of eight and a converter efficiency of 80 % has been assumed in the simulation. The new cross-sections of conductors in power cables have been calculated by demanding that the voltage drop in these cables does not exceed the maximum allowed voltage drop of today’s power supply system (4V). The width of the power and ground rails in the motherboards has been computed allowing for a maximum power loss of 3 % in those boards. The material budget of all components belonging to the relevant categories of electronics or cables is shown in Fig. 3, right. For the TECs, 30.9 % of the material in these categories can be saved within the applied model, which corresponds to a saving of 8 % for the whole TEC material budget. Simulations for the complete CMS strip tracker are less detailed but show consistent results.

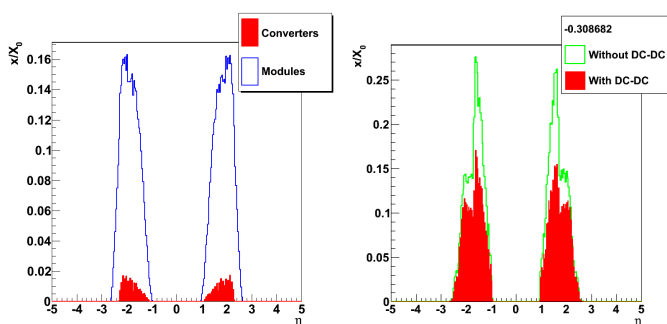

Figure 3: TEC material budget, for (left) all strip modules (open histogram) and all DC-DC converters (filled histogram), and (right) for the categories electronics and cables, in schemes without (open histogram) or with (filled histogram) DC-DC converters. The number in the legend of the right plot corresponds to the saving.

A similar study has been performed for a Serial Powering scheme [3]. All 17-28 modules of a TEC substructure were

powered in series. Additional simulated components per module include a dedicated Serial Powering chip; a bypass transistor as a safety device; and capacitors and resistors for AC-coupling of data lines. The amount of copper in cables and motherboards has been estimated as for DC-DC conversion. The gain is found to be similar: for Serial Powering, 29.0 % of the material for TEC electronics and cables and 7.5 % of the total TEC material could be saved with our assumptions.

## C. AC2 Noise Characterization

The effect of the AC2 buck converters on the noise behaviour of the current strip tracker modules has been studied in system tests. The set-up, described in detail in [5] and references therein, consists of a TEC substructure (*petal*) equipped with four silicon strip modules. The optical readout and control system is realized using prototype CMS tracker DAQ hard- and software. The APV25 readout ASIC [8] is a 128-channel chip manufactured in a 0.25  $\mu\text{m}$  CMOS process. For each channel, a charge-sensitive pre-amplifier, a CR-RC filter with a time constant of 50 ns, and a 192 cells deep pipeline are implemented. The read-out is fully analogue. The APV25 operating voltages, 2.5 V and 1.25 V, are provided by two DC-DC converters per module, which are integrated with an additional adapter board. Input voltages are provided by external lab power supplies. Supply currents per module amount to about 0.5 A and 0.25 A for 2.5 V and 1.25 V, respectively.

The quantity studied is the raw or total strip noise, defined as the RMS of the fluctuations around the pedestal. Module edge channels (strips 1 and 512) are capacitively coupled to the bias ring, which itself is AC-coupled to ground. Since the APV25 pre-amplifier input transistor is referenced to 1.25 V, noise (ripple) on this power line leads to an artificial (i.e. noise) signal at the pre-amplifier output. In addition, a common mode subtraction algorithm is implemented in the APV25, which subtracts common mode noise effectively for most channels except the noisier edge channels [5]. In consequence, edge channels provide a more direct access to the noise sensitivity of the strip module than other strips. The noise of strips 1 and 512 is added in quadrature.

A summary of results is shown in Fig. 4. The noise of the previous buck converter generation (AC1) as presented in [5] is compared with the new AC2 boards. Improvements in the AC2 with respect to AC1 include a more “linear” layout with well separated input and output rails and a larger distance between inductor solder pads. The AC1 board has been integrated using a similar adapter as for the AC2 boards. The different lengths of the AC2 boards have been compensated by additional connectors, to assure comparability of the measurements. Boards equipped with Mini Toroids or Tiny Toroids have been tested. With the Tiny Toroid, the low-ESL capacitors show a clear advantage over the standard capacitors. The IDCs in particular offer a good filtering performance. This and the fact that shielding the coil or increasing the distance did not lead to improvement suggests that the noise increase is mainly due to conductive coupling. The lower noise with Mini Toroids can be explained by the fact that the larger inductance reduces the current ripple.

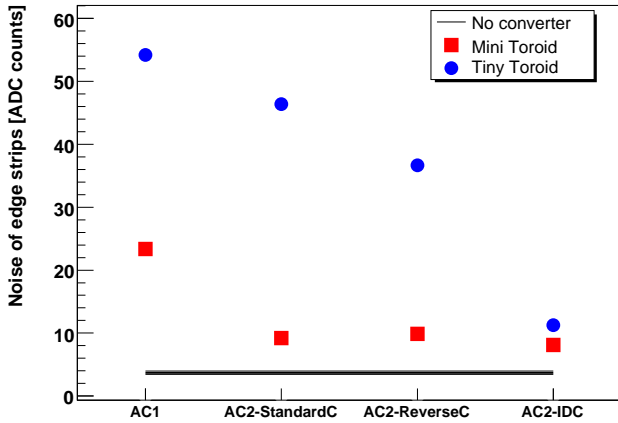

Figure 4: Combined edge strip noise for AC1, AC2-StandardC, AC2-ReverseC and AC2-IDC converters, with Mini Toroids (squares) or Tiny Toroids (circles). Here and in Figs. 7 and 8 the horizontal line represents the measurement without DC-DC converter, and its width is an estimate of the long-term reproducibility of the measurement.

The converter noise spectra have been measured with a dedicated EMC set-up [9]. The DC-DC converter is powered from a power supply via a Line Impedance Stabilization Network (LISN), and connected to an Impedance Stabilised Load. The Differential Mode (DM) or Common Mode (CM) noise current is picked up by a current probe at the input or output of the converter, and is analyzed with a spectrum analyzer. As examples, the DM noise spectra at the output are shown in Fig. 5 for the AC2-StandardC and AC2-IDC boards. The peaks up to 30 MHz have been added in quadrature, resulting in sums of 43.8 dB $\mu$ A, 41.6 dB $\mu$ A and 32.2 dB $\mu$ A for the AC2-StandardC, AC2-ReverseC and AC2-IDC, respectively. This confirms the trend observed in the system test. In contrast, the respective CM numbers of the three boards are quite similar to each other. The current strip modules are thus sensitive mainly to DM noise.

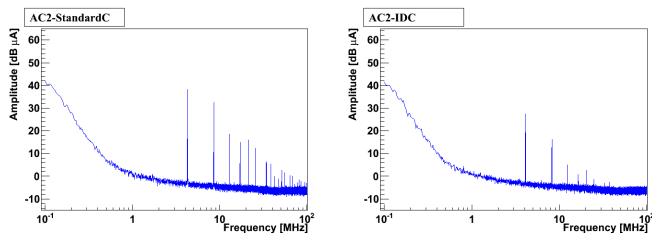

Figure 5: Differential Mode output noise spectra for (left) AC2-StandardC and (right) AC2-IDC, for an input voltage of 5.5 V, an output voltage of 1.3 V and a load current of 0.5 A.

#### D. AC2 Efficiency

The efficiency  $\eta = P_{out}/P_{in}$  of the AC2 DC-DC converters has been measured with a dedicated set-up in which both the input voltage and the load current are programmable. Both parameters were swept within the specifications of the chip. The effi-

ciency of the AC2-StandardC board with Mini Toroid is shown in Fig. 6 for an output voltage of 1.3V. Efficiencies vary between 75 % and 85 % in most of the parameter space. For half the conversion ratio the efficiency is up to (abs.) 15 % higher. Differences between capacitor types are negligible ( $< 1\%$ ).

A significant difference in efficiency is however observed between Mini Toroids and Tiny Toroids: the efficiency with the Mini Toroid is 5-30 % higher than with the Tiny Toroid, in spite of the lower DC-resistance of the latter. A larger current ripple  $\Delta I$  in Tiny Toroids and thus higher associated losses  $\propto (I_{out} + \Delta I)^2$  in the coil and losses  $\propto (\Delta I)^2$  in output filter capacitors might be the reason. Mini Toroids with their three times higher inductance are therefore preferred over Tiny Toroids, in spite of their slightly larger mass and size.

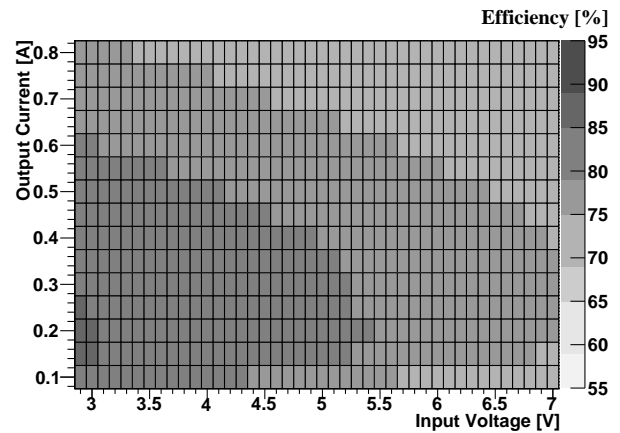

Figure 6: Efficiency of the AC2-StandardC board with Mini Toroid, for an output voltage of 1.3 V, as a function of input voltage and output current.

#### E. AC2 Boards with Filters

As is evident from system tests, the noise increase in current strip modules with the AC2 boards is mainly due to conductive DM noise, i.e. a ripple on the power line. Filtering should therefore improve the situation further. Two options have been studied: “ $\pi$ -filters” (Butterworth filter) with two equal capacitors and one inductor, and a Low DropOut (LDO) regulator.

The filters have been realized as independent small PCBs that can be plugged to the AC2 boards, either at the input or the output. As LDO regulator the LTC3026 from Linear Technology [10] was used, with a dropout of 50 mV. Four versions of  $\pi$ -filters have been tested:  $L = 2.55$  nH /  $C = 22$   $\mu$ F or  $L = 18.5$  nH /  $C = 3.2$   $\mu$ F for a cutoff frequency of 0.95 MHz; and  $L = 2.55$  nH /  $C = 2.2$   $\mu$ F or  $L = 18.5$  nH /  $C = 220$  nF for a cutoff frequency of 3 MHz. The combinations for one cutoff frequency differ in the characteristic impedance. The 2.55 nH coils with a DC-resistance of 5 m $\Omega$  would be preferred, as they add less material and require less space.

Results for filtering at the converter output are shown in Fig. 7, for all three variants of AC2 boards (equipped with Tiny Toroids). Both with LDO regulator and  $\pi$ -filter a drastic decrease of the edge strip noise is observed for all three AC2 vari-

ants. *Dummy* corresponds to an unpopulated PCB of the size of the filter boards with a direct solder connection between the inductor pads. This cross-check shows that the board itself and the associated change of position leads to a slight decrease of noise, but cannot explain the improvement observed with real filters. Measurements with the EMC set-up described above confirm that the DM noise is reduced to a level below the sensitivity of the set-up, except for the filter with 18.5 nH / 220 nF (which still shows a drastic improvement). As expected, the CM noise was not reduced by filtering.

Filtering the input of the converter was tested as well but did not improve the edge strip noise significantly.

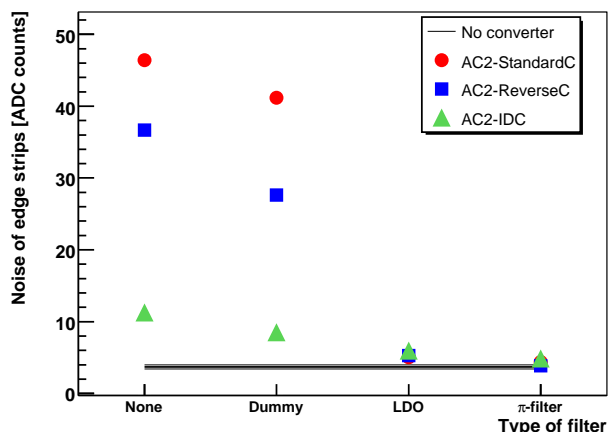

Figure 7: Combined edge strip noise for AC2-StandardC (circles); AC2-ReverseC (squares) and AC2-IDC (triangles) converters, for various filtering options. Details are given in the text.

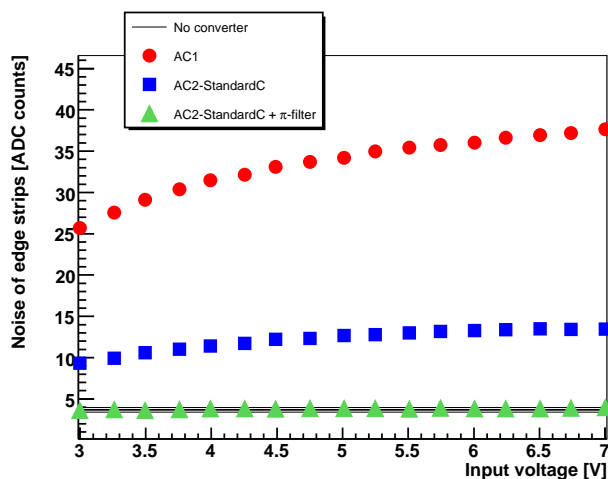

Figure 8: Combined edge strip noise for AC1 (circles); AC2-StandardC (squares); and AC2-StandardC with  $\pi$ -filter (triangles); as a function of the input voltage.

A high efficiency is crucial and measures to reduce the noise impact of the converters should deteriorate the efficiency as little as possible. The efficiency with LDO filter or  $\pi$ -filter was measured and compared with the efficiency without filter. While the

LDO regulator reduces the efficiency by typically 5 %, the efficiency loss with  $\pi$ -filter is below 1 % in the whole accessible parameter range. The  $\pi$ -filter is thus the favoured filtering device, due to its good filtering performance, small efficiency loss, low complexity and intrinsic radiation-hardness.

Figure 8 shows the result of a scan of the input voltage. While both the previous board (AC1) and the AC2-StandardC show a rise of the noise with input voltage, the measurement of AC2-StandardC with  $\pi$ -filter is on top of the measurement without converter across the whole input voltage range. These measurements have been performed with the Mini Toroid.

### III. NOISE SUSCEPTIBILITY STUDIES

The commercial buck converter used on the AC2 boards switches at 4 MHz, while custom radiation-hard converters will be optimized for switching frequencies of 1-2 MHz, to reduce switching losses. It is important to understand the susceptibility of the future tracker modules to conductive noise as a function of the noise frequency, in order to identify critical bandwidths that should be avoided for the converter switching frequency. A test bench based on the Bulk Current Injection (BCI) method has been set up [9]. As the proposed successor of the APV25, the *CMS Binary Chip* [11], will not be available before early 2010, the susceptibility of today's silicon strip modules is currently being studied.

A strip module is powered via a LISN directly from a lab power supply. Noise is generated by a sine wave generator, amplified by a +50 dB amplifier and injected by an inductive current probe into the power lines. A second current probe is used to pick up the injected noise current, whose amplitude is then measured with a spectrum analyzer. While the noise frequency is swept, the amplitude of the noise current is kept constant. Noise currents in DM and CM of 70 dB $\mu$ A have been injected into the 2.5 V and 1.25 V power lines.

Figure 9 shows the result for the peak readout mode of the APV25, in which only one sample is used (results in deconvolution readout mode, in which a weighted sum of three consecutive samples is formed, are similar). A peak at 6-8 MHz is observed. From the APV25 shaping time of 50 ns the highest susceptibility is expected at 3.2 MHz. The response is therefore not dominated by the bare front-end electronics but reflects the behaviour of the whole module. The observed peak is well above the expected future switching frequency, although higher harmonics peaks will extend into the sensitive region.

The susceptibility is highest for injection of DM noise at 1.25 V. This is understood to be due to the fact that the pre-amplifier is referenced to 1.25 V. A ripple on this power line leads to artificial noise injection, as indicated earlier. This has been proven experimentally with a modified silicon module, in which the bias ring was AC-coupled to 1.25 V instead of ground. This module showed very little sensitivity to injected noise. In the *CMS Binary Chip*, the pre-amplifier will be referenced to ground.



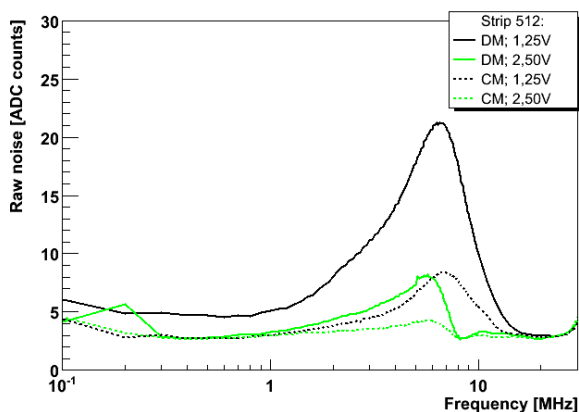

Figure 9: BCI results for a noise current of  $70 \text{ dB}\mu\text{A}$ , for DM (solid lines) and CM (dashed lines) at 1.25 V (black) and 2.5 V (grey/green). The noise of strip 512 is shown as a function of the noise frequency. The step width was 100 kHz up to 10 MHz and 1.0 MHz above.

#### IV. DC-DC CONVERTERS FOR THE CMS TRACKER UPGRADE

##### A. Pixel Upgrade for SLHC Phase-1

The current pixel detector will be replaced for phase-1 with a larger device. The number of barrel layers will be increased from three to four, and the number of forward disks will grow from two to three per side. The number of readout chips per cable and power supply increases considerably, leading to larger supply currents and consequently higher voltage drops on supply cables. The possibility of a bare power supply upgrade has been studied and found to be unfeasible. However, DC-DC converters with a conversion ratio around two could be used with only lightly modified power supplies. Buck converters would be installed on the pixel supply tube at a pseudorapidity of  $\approx 4$ , i.e. outside the sensitive tracker region, where more space is available and the mass of the converter is not so critical. Due to the distance to the pixel modules on the one hand and the fact that the readout ASICs are equipped with linear regulators on the other hand a certain amount of conductive and radiative noise will be tolerable.

##### B. Outer Tracker Upgrade for SLHC Phase-2

The layout of the future outer tracker is under development. DC-DC buck converters are currently foreseen both for track

trigger layers, where currents of several Amps per module and a high conversion ratio might be required, as well as for the less demanding readout layers. As the modules are being optimised for low mass, the space constraints are severe. Separate “power boards” carrying the converters seem most feasible and could be integrated on the module periphery or the support structure.

#### V. SUMMARY

DC-DC buck converters based on a commercial, not radiation-hard chip, and small, light-weight air-core toroids have been developed. The noise performance has been studied extensively in system tests. In combination with  $\pi$ -filters, which lead to an efficiency loss below 1%, the boards can be operated across the whole allowed input voltage range without adding extra noise to the test system. The material budget of the AC2 converters amounts to 10% of the material of a current strip module. Due to savings in cables and motherboards, about 8% of material could be saved by using such converters (for an efficiency of 80% and a conversion ratio of eight). Plans exist to use buck converters for the pixel detector already in phase-1 and in the outer tracker during phase-2. These studies will therefore be continued using custom radiation-hard converter ASICs.

#### REFERENCES

- [1] The CMS Collaboration, JINST **3** S08004M 2008.
- [2] G. Hall, TIPP09, CMS CR-2009/042, 2009.
- [3] N. Wermes *et al.*, Nucl. Instrum. Meth. A565 (113-118), 2006.
- [4] R. W. Erickson, *DC-DC Power Converters*, Wiley Encyclopedia of Electrical and Electronics Engineering, 2007.
- [5] K. Klein *et al.*, TWEPP-08, CERN-2008-008.
- [6] Enpirion, USA; <http://www.enpirion.com/>
- [7] IEEE Trans. Nucl. Sci. **53** (270-278) 2006.
- [8] M. Raymond *et al.*, LEB 2000, CERN-2000-010 (2000).
- [9] R. Jussen, Diploma Thesis, RWTH Aachen University, CMS TS-2009/009.
- [10] Linear Technology, USA; <http://www.linear.com/>
- [11] M. Raymond and G. Hall, TWEPP-08, CERN-2008-008.