

INVESTIGATION AND CURES OF LONGITUDINAL INSTABILITIES  
OF BUNCHED BEAMS IN THE ISR

P. Bramham, S. Hansen, A. Hofmann, K. Hübner and E. Peschardt

CERN

Geneva, Switzerland

(Presented by W. Schnell)

Summary

The present status of longitudinal bunched beam instabilities in the ISR is described. Experiments to test the theory have been conducted with a tunable, passive cavity. In order to cope with the instability at higher intensities we expect in the future, possible cures were investigated. A bunch-by-bunch feedback system has been built. It damps dipole and quadrupole oscillations of individual bunches. Stabilization by means of a passive cavity was also successfully demonstrated.

1. Introduction

The RF system in the ISR is mainly used to accelerate the injected beam for stacking in longitudinal phase space. It works at the 30th harmonic of the revolution frequency. The injector, the CERN proton synchrotron, has the same RF frequency but its circumference is only 2/3 of the ISR. Hence, the injected beam consists normally of 20 consecutive bunches. They are trapped on the injection orbit in 20 large, stationary buckets with the help of a phase lock system; the remaining 10 buckets are left empty. Each bunch covers a longitudinal phase space area of 0.16 eVs. The phase oscillation frequency is around 60 Hz and the injected beam current equals  $\sim 75$  mA. The bunches stay in these large buckets for approximately 10 phase oscillation periods until the shutter protecting the stack from the stray field of the inflector magnet has opened. Subsequent acceleration with the same voltage displaces the beam towards the stack. Before the beam approaches the stack the voltage is reduced to fit the buckets tightly to the bunches. This avoids bringing empty phase space into the stack, which would dilute its density. The stable phase angle, whose typical value is  $35^\circ$ , is kept constant during the whole acceleration. After a final acceleration with the reduced voltage to the stacking orbit the voltage is cut off abruptly. Fig. 1 shows the voltage and frequency programmes. The total length of such a stacking cycle is determined by the repetition rate of the injector. It is around 2 s.

During the time the bunch spends in the large bucket, phase oscillations develop and subsequent filamentation leads to dilution of the longitudinal phase space density. Since the maximum current which can be stacked is proportional to the longitudinal phase space density, performance will be reduced. Therefore, a study of these oscillations as well as of possible cures was in order.

2. Observation of Phase Oscillations

In order to observe these phase oscillations we kept the beam usually on injection orbit with a constant RF voltage, rather than going through the normal RF programme. A wide-band, fast intensity monitor and a "mountain range" display were our main tools for beam observation. With this set-up the longitudinal position

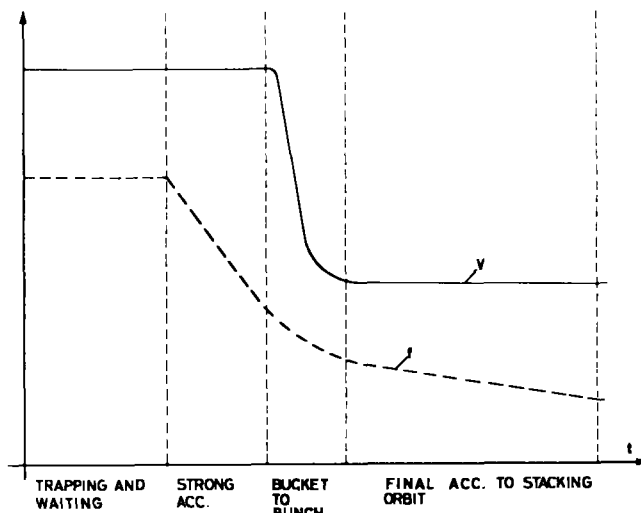

Fig. 1. Voltage and frequency programmes during an acceleration cycle.

of a bunch as well as its shape could be observed during the development of the instability.

The first objective of our investigation was to find the mode of the oscillation of a particular bunch. The dipole mode (rigid bunch mode) oscillation, which is described here with the mode number  $m = 1$ , was usually dominant, but also some quadrupole mode,  $m = 2$ , could be observed. Fig. 2 shows these oscillations for two different RF voltages  $\sim 3.8$  s after injection on a "mountain range" display.

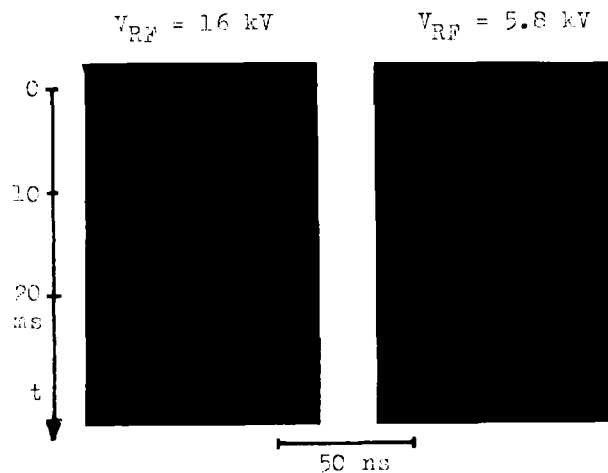

Fig. 2. "Mountain range" display of bunch oscillations for two different RF voltages

For the lower RF voltage, the bunch is longer and the quadrupole mode is more pronounced, as expected.

As a next step we studied the coupling between the bunches which is characterized by the phase relation between the oscillations of different bunches. An obvious such relation can be seen in Fig. 3 which shows the dipole oscillations of four bunches  $\sim 3.8$  s after injection.

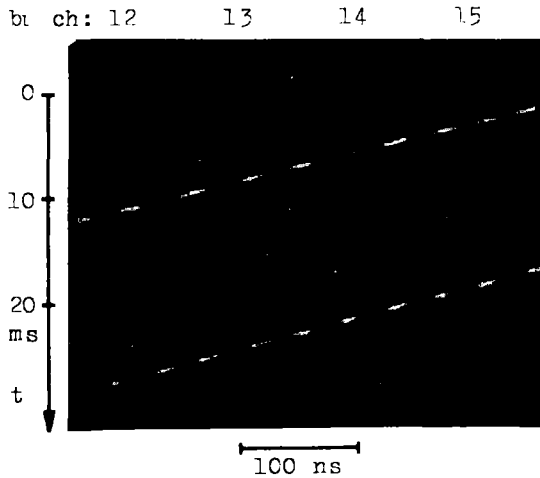

Fig. 3. Coupled bunch oscillations. Bunches with the same phase are connected by the oblique, dashed line.

On this picture the phase difference from one bunch to the next is

$$\Delta\phi \sim \frac{25}{30} 2\pi.$$

This phase difference can be described by a mode number  $n$  so that

$$\Delta\phi = 2\pi \frac{n}{h}$$

where  $h$  is the harmonic number of the RF.

Finally we measured the growth rate  $\Delta\omega_m$  of the instability. By taking "mountain range" pictures at different times after injection we can observe the growth of the amplitudes of the different modes  $m$ . In the case where the dipole mode is dominant, we took "mountain range" pictures with many sweeps, triggered every revolution, on the same trace. Each trace then shows in superposition several phase oscillations and the growth of their amplitude can be measured directly from a single picture (Fig. 4).

These methods were used to investigate the longitudinal instability we presently observe for bunched beams in the ISR. We found that for standard conditions ( $V_{RF} = 16$  kV,  $I \sim 80$  mA) our instability is a coupled bunch phenomenon consisting mainly of dipole mode oscillations with a growth rate of

$$\Delta\omega_1 \sim 1.6 \text{ s}^{-1}$$

and some weaker quadrupole oscillations.

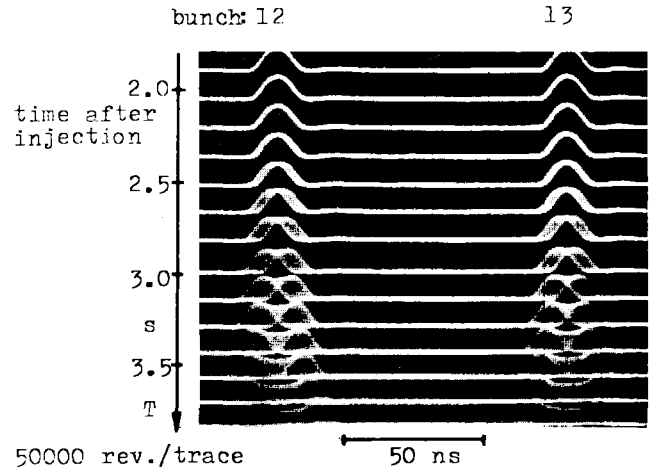

Fig. 4. Growth of dipole instability

### 3. Comparison of Theory and Experiment

#### Review of the Theory

Basically the longitudinal stability of the bunches in the ISR is determined by two effects: (a) the spread  $S$  of phase oscillation frequency  $\omega_s$  due to the non-linearity of the RF waveform; (b) the longitudinal space charge force which shifts the coherent phase oscillation frequency with respect to the incoherent distribution and hence can make ineffective the Landau damping due to the spread  $S$ .

For typical ISR bunches in stationary buckets this space charge effect is quite large and Landau damping is ineffective. The situation is therefore potentially unstable which means that a resonator of arbitrarily small shunt impedance can cause an instability.

A theory describing the effect of such resonators on bunched beams has been worked out by F. Sacherer<sup>2</sup>. Below we summarize it briefly and apply it to the ISR. This theory applies to beams with equidistant bunches and gives the modes  $m$  and  $n$  as well as the growth rates of the oscillations which are excited by a resonator having a resonant frequency  $f_{res}$  and a shunt impedance  $R_s$ . Since we have in the ISR 20 bunches followed by 10 empty buckets, rather than equidistant bunches, Sacherer's theory is not directly applicable and a correct treatment is complicated. However, for a resonator which has a quality factor  $Q$  large enough for its signal not to decay too much during the time of  $\sim 1 \mu\text{s}$  while the empty buckets pass by, we can use this theory as a good approximation. For the ISR beam in stationary buckets the growth rate of the instability is then:

$$\Delta\omega_m \approx \frac{\omega_s R_s I D F_m(\Delta\phi)}{2\pi V_{RF} B}$$

where

$I$  = beam current,

$V_{RF}$  = RF voltage and

$B$  = bunching factor = full bunch length/distance between bunches.

The form factor  $F_m(\Delta\phi)$  specifies how efficiently the resonator can drive a certain mode  $m$ . It depends on

the phase change  $\Delta\phi = 2\pi \times$  bunch length in seconds  $\times$   $f_{res}$ , which occurs during the passage of a bunch (cf. Fig. 5). The term  $D$  depends on the attenuation of the resonator signal between two bunches and on the ratio

$$k = \frac{f_{res}}{f_0}$$

between the resonant frequency  $f_{res}$  and the revolution frequency  $f_0$ . This factor  $D$  has in general an imaginary part which is, for our assumption of large  $Q$ , of about value 1 if

$$k \approx \text{integer} \times h \pm n,$$

but of value zero for the coupled modes  $n = 0$  and  $n = 15$ .

The above equation determines which coupled bunch mode  $n$  will be excited. How well it has to be satisfied depends on the bandwidth of the resonator.

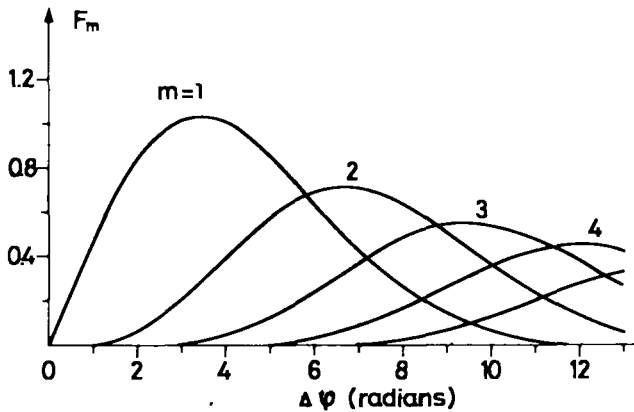

Fig. 5. Form factors  $F_m(\Delta\phi)$  (from F. Sacherer<sup>2</sup>)

#### Experimental Test of the Theory

We tested the theory and its validity for the ISR case using a cavity<sup>3</sup> with variable shunt impedance and resonant frequency. The excited modes and their growth rates were measured using the methods described in the last chapter. The experimental results are listed in Table 1 and compared with the calculations. The agreement is quite good considering the rather large measurement errors. For each case in Table 1 only the mode with the strongest oscillation is shown, because its presence may change the condition for the weaker modes and also makes their measurement difficult.

#### Application of the Theory

Having now tested the theory (at least for some range of resonant frequencies) we can use it to derive a criterion for the maximum shunt impedance  $R_{max}$  a resonator in the ISR is allowed to have, if a certain instability growth rate  $\Delta\omega_{max}$  is tolerated. We assume a beam current of  $I = 0.1A$ , stationary buckets with  $V_{RF} = 16$  kV and we approximate the curves  $F(\Delta\phi)$  by their envelope and get for  $k > 75$ :

$$R_{max} \sim 40\sqrt{k}\Delta\omega_{max} \quad \Omega$$

Since we assumed  $|D| = 1$ , this criterion might be pessimistic.

Table 1

Comparison of Theory and Experiment

beam energy	GeV	26	26	26	22	22
beam current	mA	90	30	90	90	90
RF voltage	kV	16	16	5.8	16	16
bunch length	ns	16.5	15.5	22	17.5	17.5
shunt impedance	k $\Omega$	5.2	5.2	5.2	13	13
$k = f_{res}/f_0$		175	175	175	153	177
strongest observed mode $m$		2	2	2	2	2
<u>growth rate</u>						
observed	s <sup>-1</sup>	12.5	2.7	2.4	11.8	16.7
calculated	s <sup>-1</sup>	6.9	2.6	8.5	16.8	18.4
<u>mode <math>n</math></u>						
observed		-	5	-	27	3
expected		5	5	5	27	3

As a further application of the theory we can use instability observations to estimate the parameters of the possible resonator. By measuring the growth rate of the dominant modes  $m$  for different RF voltages and hence bunch lengths, we get some idea of where on the curves  $F_m(\Delta\phi)$  we are operating. This determines  $\Delta\phi$  which is directly related to the resonator's frequency. Observation of the coupled bunch mode  $n$  may give additional information about  $f_{res}$ . A comparison between the oscillation amplitudes of the first bunch (after the gap of the 10 empty buckets) and later bunches can be used to estimate the quality factor  $Q$ . The measured growth rate and  $Q$  determine the shunt impedance of the resonator. This method has been successfully used in the past to identify an instability-causing resonator in the ISR which then could be shorted out. The present instability observations, as described in the last chapter, indicate a resonator with  $R_s \sim 1.5$  k $\Omega$ ,  $f_{res} \sim 20$  MHz and  $Q \sim 15$ , if the instability is caused by only one resonator.

#### 4. Increase of the Landau Damping with a Cavity Operating at a Harmonic of the RF Frequency

A cavity operating at a harmonic  $p$  of the RF frequency can increase the Landau damping and provide longitudinal stability for bunched beams<sup>4</sup>. With a passive cavity we made some experiments to study this method. While dipole and quadrupole mode oscillations can be damped with the feedback system described in the next chapter, a cavity could be used to damp possible higher modes. Ideally such a cavity should be driven by an oscillator and have a low shunt impedance. Operating with the correct phase and with a voltage  $V_p$  it would produce a spread  $S_p$  in phase oscillation frequencies of approximately<sup>4</sup>

$$S_p \sim S_0 \left[ 1 + \frac{V_p}{V_{RF}} (p^3 - p) \right],$$

where  $S_0$  is the spread obtained with the normal RF system alone. This is a good approximation as long as the bunch length is smaller than the wavelength of the higher harmonic oscillation and  $V_p/V_{RF} < 1/p$ .

It is also possible to work with a passive cavity which is driven by the beam. For optimum operation it has to be tuned to a frequency which is about half a bandwidth below  $p \cdot f_{RF}$  so that the phase  $\psi$  between this cavity oscillation and the bunch is  $\sim 45^\circ/p$  as shown in Fig. 6,<sup>5</sup>. The spread obtained is then

$$S_p \sim S_0 \left[ 1 + \frac{I_p R_s}{2V_{RF}} (p^3 - p) \right]$$

where  $I_p$  is the  $p \cdot f_{RF}$  - Fourier component of the beam current. Due to the shunt impedance  $R_s$  and the finite bandwidth such a cavity can itself excite instabilities. The damping provided by the cavity has to cope with their growth rates and the space charge frequency shift.

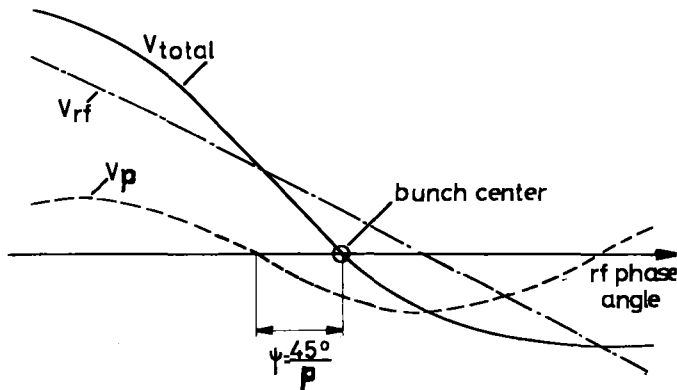

Fig. 6. Phase relation between the oscillation of the higher harmonic cavity, the bunch and the RF voltage.

In our experiments we used a cavity with variable shunt impedance operating at the 6th harmonic of the RF

frequency. With  $p = 6$  this cavity is not quite ideal because the wavelength of its oscillation is shorter than the bunch length at the end of the acceleration cycle. This cavity can therefore not be used for stacking and all the experiments were done with bunches in stationary buckets.

With this method all bunches could be kept stable for a long time as shown in Fig. 7. Usually some oscillations showed up after some time. We do not know if they are caused by a real instability or by noise. Such oscillations either got damped out (as in Fig. 7) or they upset the driving of the cavity, in which case a violent instability occurred. The lowest shunt impedance of the cavity necessary to provide stability was measured and found to be in good agreement with theory. To appreciate the damping effect of the cavity Fig. 7 should be compared with Fig. 4 which refers to normal conditions.

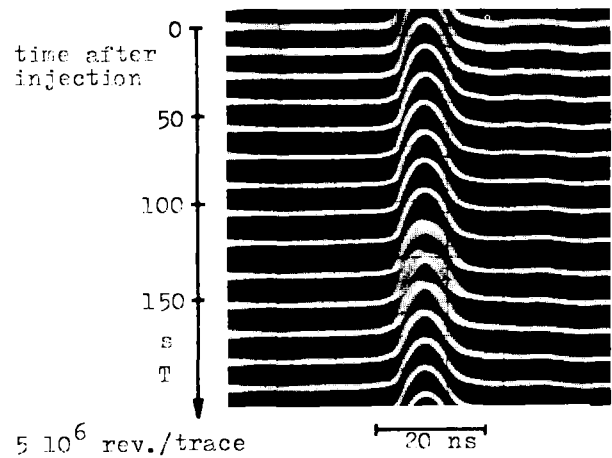

Fig. 7. A bunch stabilized with the higher harmonic cavity.

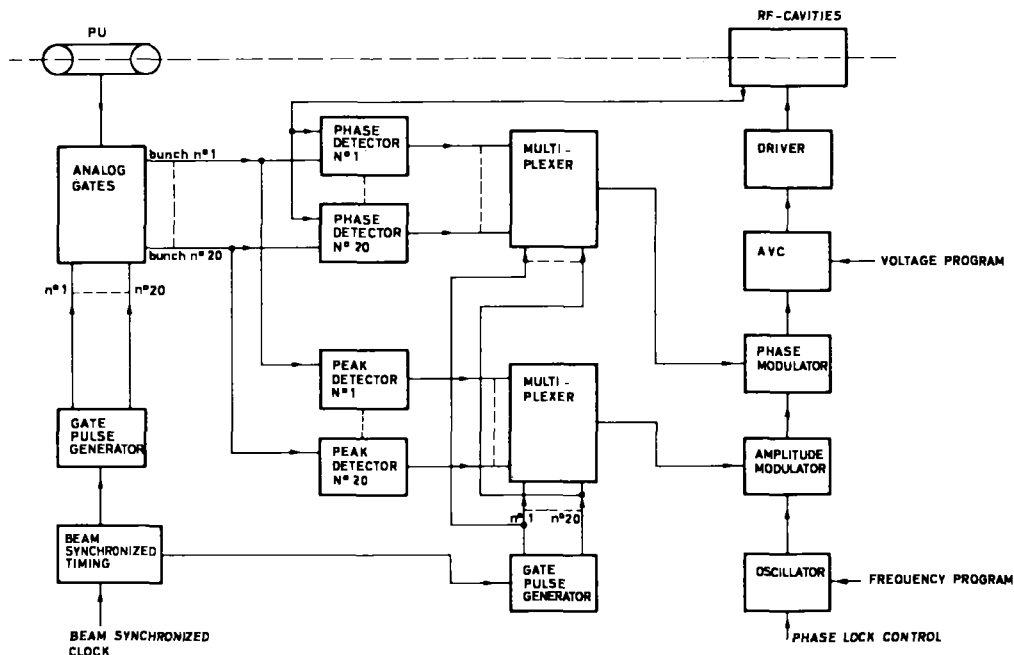

Fig. 8. Block diagram of the feedback system

## 5. The Bunch-by-Bunch Feedback System

One method of damping bunch oscillations of the dipole and quadrupole mode is to act directly on the phase and amplitude of the RF voltage. The ISR RF system works with beam control<sup>1</sup> (missing bunch phase-lock), where the beam phase-reference is taken from one single bunch. The dipole mode of bunch oscillations thus appears as a phase-modulation of individual bunches with respect to the reference bunch, with a frequency  $\omega_s$  equal to the synchrotron frequency. A pure quadrupole oscillation appears as an amplitude modulation of the individual bunches. The frequency of the amplitude modulation is  $2\omega_s$ .

By detecting these phase and amplitude modulations of individual bunches and using the detected signals to modulate the RF wave seen by the same bunches, these oscillations can be damped. Such a system has been built for the ISR.

Fig. 8 shows a simplified block diagram of the feedback system. The signal induced on a pick-up station is fed into an analogue gating system, where the 20 bunches are separated. Twenty phase-detectors measure the instantaneous phase difference between each individual bunch and the RF voltage on the cavities. In the multiplexer, the error signal from each detector is sampled once per revolution for approximately 105 ns (one RF period). The output signal from the multiplexer is a signal representing the phase-deviation between the individual bunches and the RF voltage. This signal is applied to a fast phase-modulator that varies the phase of the RF cavity voltage.

Due to a relatively low Q-value of the RF cavities<sup>6</sup>, fast changes of phase and amplitude of the RF voltages are possible, when these changes are small.

Twenty peak-detectors measure the amplitude modulation of individual bunches. An identical multiplexing system as described above is used to extract a signal related to the amplitude of the bunch oscillations for each individual bunch. This signal modulates the amplitude of the RF voltage.

All the switching processes are guided from the beam-synchronized timing system.

## Experimental Results

The feedback system is built so that any number of bunches from 1 to 20 can be damped individually. Dipole oscillations of 1 and 2 of the 20 bunches have been successfully damped, in the presence of violent oscillations of both the leading and lagging neighbouring bunches. Fig. 9a shows two neighbouring bunches when no feedback is applied. Fig. 9b shows the same bunches when feedback is applied only to the last bunch.

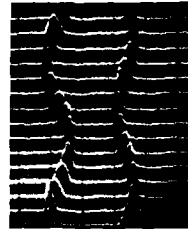

Fig. 9a. Dipole oscillations without feedback

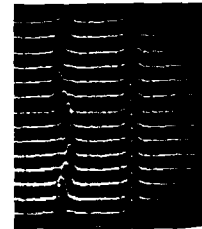

Fig. 9b. Second bunch stabilized by feedback

An experiment measuring the overall effect on the final phase plane density in a stack when feedback is applied to all 20 bunches has not yet been performed.

### References

1. S. Hansen, M.J. de Jonge: "Beam control and RF stacking in the ISR." Proc. of the 8th Int. Conf. on High Energy Accelerators, CERN 1971, p.505.
2. F. Sacherer: "A longitudinal stability criterion for bunched beams." Proc. of the 1973 Particle Accelerator Conference, San Francisco, p.825. This paper also gives an extensive list of references.
3. B. Zotter and P. Bramham: "Experimental investigation of the coherent longitudinal instability of relativistic particle beams." Proc. of the 1973 Particle Accelerator Conference, San Francisco, p.830.
4. R. Averill *et al.*: "Synchrotron and betatron inst. of stored beams in the CEA." Proc. of the 8th Int. Conf. on High Energy Accelerators, CERN 1971, p.301.
5. G.A. Voss, private communication.
6. F.A. Ferger and W. Schnell: "The high power part of the RF system for the CERN Intersecting Storage Rings (ISR)." USSR 2nd Nat. Conf. on Particle Accelerators, 1970, Vol. II, p.129.

## DISCUSSION

Matt Sands (UCSC): Can you explain how the feedback system works for the quadrupole mode?

Wolfgang Schnell (CERN): First, there is a separate detector and separate channel for each bunch with multiplexers. I think that's not what you wonder about. The other thing is rather well known, the basic principle, the quadrupole oscillation means that the bunch gets long and short periodically. When it's short, it's dense and so the peak induced voltage in the pickup is high. When it's long, it's low. The next stage is that you modulate the rf voltage with twice the phase oscillation frequency and you find that it spirals in phase space. This is well known and is used in several machines. I know it's used in the PS and the AGS for many years. The new thing for us is that it's individual from bunch to bunch.

Gus Voss (DESY): At the PS it is called Aragon damping, is it not?

Schnell: Yes. I believe it's called Racah damping at Brookhaven.

Arie Van Steenbergen (BNL): Would you give us some more detail on your injection kicker which has no shutter.

Schnell: We are working on this—the beam height is smaller than we expected and we usually make it even smaller by shaving away a lot of beam. Then instead of having a moving shutter you can perhaps get away with having the beam in a narrow slot where the field attenuates very rapidly when it penetrates into the slot. The trouble is that we can probably not use it at the lowest energies that we have to run, so we will try to work this into the moving shutter and then have both systems.

Gus Voss (DESY): You lose a little bit of radial aperture, I guess, with such an arrangement.

Schnell: A few millimeters, yes. This doesn't work yet, this is under development.

Alberto Renieri (Frascati): What is the order of magnitude of modulation of the rf for damping the quadrupole mode?

Schnell: A few percent. I think it's no more than two or three percent.