

THE POLARIZATION OF 660 MEV PROTONS

M. G. MESHCHERIAKOV, S. B. NURUSHEV and G. D. STOLETOV

Institute of Nuclear Problems, USSR

(presented by M. G. Meshcheriakov)

Summary

Results of experiments on double scattering of protons with an initial energy of 660 Mev are described. Measurements were made of the angular dependence of the asymmetry in the scattering of polarized 565 and 635 Mev protons on beryllium. The polarization in quasi-elastic scattering at 635 Mev was determined by the conjugated telescope method. Results are given of measurements of the asymmetry at an angle of 9° in the scattering of protons on carbon, aluminium, lead and bismuth at the registration thresholds of 230 and 620 Mev.

1. Introduction

Formerly proton polarization effects in scattering on nuclei had been observed right up to 439 Mev in experiments on the double scattering of initially unpolarized beams¹⁻⁶). It was found that proton polarization reaches its maximum value at the energies and angles corresponding to the diffraction scattering of protons on nuclei. The value and direction of the spin polarization can be explained qualitatively on the assumption about the presence of the same spin-orbit interaction as is accepted in nuclear shell models⁷⁻¹⁰).

Polarization effects in nuclear scattering of protons with an initial energy of 660 Mev were investigated in this work.

2. Production of polarized protons

The first scattering of protons took place inside a six-meter synchrocyclotron on a four-centimeter beryllium target (polarizer) placed into the circulating 660 Mev proton beam. Obviously only diffraction scattering of protons by nuclei, and the single quasi-elastic p-p and non-exchange p-n scattering at small angles do not cause large losses of proton energy. In the first case, the scattered protons are concentrated in a narrow forward cone with an angle of the order of $2\lambda/R$ (λ is the incident proton wave length, R is the nucleus-scatterer radius) and have a limiting energy a little below the initial energy, if such collisions are not accompanied by transitions of the nuclei into excited states; in the second case, due to the nucleon zero oscillations in the nucleus there is no correlation between the scattering angle and the particle energy, as a result of which the nucleon scattering has quite a broad energy distribution with a peak in about the same region

as for free collisions. The angular distribution of quasi-elastic scattered nucleons must in general be the same as in the elastic scattering of free nucleons. As for the nuclear cascade and the nucleon collisions connected with pion production, these processes are accompanied by emission of protons with energies considerably below the quasi-elastic scattered proton energies.

Direct data on the energy distribution of primarily scattered protons were obtained in our laboratory by measuring the momentum spectra of p + Be collision products with an analyser magnet¹¹). One of the first results of these measurements was the observation at the angles of 7.3° and 12.2° to the primary beam of a pronounced peak corresponding to the diffracted protons. At the angles of 18° , 24° and 30° in the high-energy region of the spectra there are only quasi-elastically scattered protons.

In these experiments, two polarized beams were used, the paths of which are shown in fig. 1. One of them (beam A) comprised only protons that underwent quasi-elastic

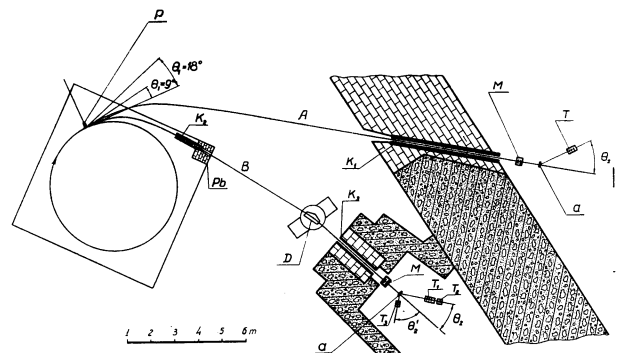

Fig. 1. Experimental arrangement.

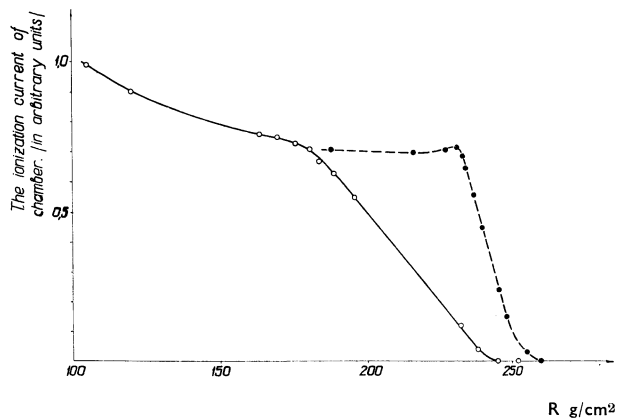

Fig. 2. Absorption curves for protons in copper. — for the beam A, ---- for the beam B.

scattering towards the left at an angle of 18° . The inelastically scattered protons and protons emitted in the nuclear cascade process were sifted out of the beam, due to the analysing action of the synchrocyclotron's fringing magnetic field. The beam A passed through a steel collimator K_1 , 3.6 meters long, arranged in the four-meter ferro-concrete shielding wall, and fell onto a second scatterer (analyser). At the location of the analyser the beam intensity was about 10^4 protons per cm^2 per sec. The solid curve in fig. 2 shows the results of measurements in beam A of the proton absorption in copper. From these results it follows that the protons have a mean energy of about 565 Mev and an energy spread of ± 60 Mev. Taking into account the slowing down losses in the polariser, the value of the average energy found proved the same as in the free p-p scattering at an angle of 18° .

Beam B, consisting of protons scattered to the left at an angle of 9° , was produced inside the synchrocyclotron tank with the use of a steel collimator K_2 which at the same time was a magnetic channel and, upon its ejection into the atmosphere, was additionally deflected through the angle of 9° by a purifying magnet. All this improved the monochromatism of the beam and excluded the possibility of the particle falling directly from the synchrocyclotron chamber into the shielded space. The beam intensity beyond the collimator K_3 at the location of the analyser was 10^5 protons per cm^2 per sec. In this case too the proton energy was determined by the mean range in copper, which, as seen in fig. 2, proved to be 242 gm. per cm^2 , corresponding to an energy of 635 ± 15 Mev. In these experimental conditions protons of the same energy should be emitted in diffraction scattering at an angle of 9° . Assuming that the quasi-elastically scattered proton spectrum in the region of small angles is similar in form to the spectrum at the angle of 24° , one could separate the diffraction peak from the continuous distribution in spectra measured at angles of 7.3 and 12.2° . Thus, by the ratio of the area under the corresponding curves one can estimate the admixture of quasi-elastically scattered protons in an energy interval 30 Mev wide, the centre of which coincides with the

maximum of the diffraction peak. For the above mentioned angles it proved to be 9 and 28%, from which it was calculated by interpolation that the admixture of quasi-elastically scattered protons in the beam B was about 16%. In fig. 3 spectra of primary scattered protons separated in this way are shown for the angles of 7.3° and 12.2° .

For tracing beams A and B within the synchrocyclotron tank and in the fringing magnetic field, the current carrying wire method was applied, a small mirror being rigidly connected to the wire at its fastening to the polarizer. After changing the location of the wire from the path of the circulating beam to a position corresponding to the path of the scattered proton beam, the angle of rotation of the mirror was measured. The collimators were arranged coaxially with the beams to an accuracy of $\pm 2'$. Normally the beam diameter near the analyser was 3 cm. The constancy of the intensity across the beam cross section was established by means of photographic images on nuclear plates.

3. Method of measurement

The secondary scattered protons were registered by telescopes composed of two and three scintillation counters in coincidence. Tolan crystals were used, with a thickness of about 3 mm., encased in aluminium foils so as to reflect the scintillation light on the photocathode of the electronic multiplier. The photo-multipliers were carefully protected from stray magnetic fields by soft iron and permalloy screens. The coincidence circuit resolving time in the telescopes was about 3×10^{-8} sec. The proton counting efficiency was close to 100 per cent. The proton energy threshold was determined by the thickness of the copper filter in the telescope.

The arrangement for the second scattering was a round inclinometer disk 800 mm. in diameter, in the centre of which a scatterer-analyser was placed. The analyser could

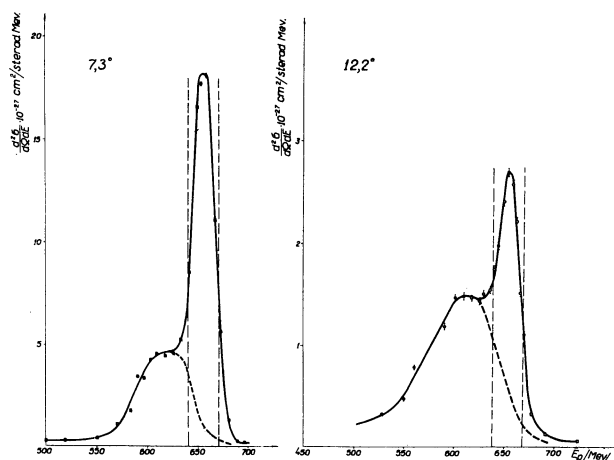

Fig. 3. Energy spectrum of protons from p + Be collisions at 600 Mev.

be removed from the beam or replaced by another with a remote control device. The telescopes were fixed on bars that could rotate in the scattering plane around an axis passing through the analyser, and be set up at a given angle to the proton beam. The zero position on the angle scale was matched with the beam central path to an accuracy of $\pm 3'$, and measurements were controlled regularly by photography. In the same way the position of the counters in the scattering plane were controlled. The beam intensity was registered by an argon-filled ionization chamber and an integrating d.c. amplifier.

In general, the experiments were reduced to measurements of the asymmetric angular dependence determined by the relation $\varepsilon = (L - R)/(L + R)$, where L and R are normalized counting rates of secondary protons scattered to the left and to the right at the same angles to the primary scattered proton beam. The planes of the two scatterings coincided. At large observation angles, the counting rate of triple coincidences without analyser in the beam did not exceed 1 per cent. As the angle diminished, the background level increased, almost entirely as a result of the proton scattering within the walls of the collimator.

4. Polarization of 565 Mev protons *

To determine the angular dependence of the asymmetry of secondary proton scattering emitted at an angle of 18° in 660 Mev proton bombardment of beryllium, experiments were made in the beam A at angles θ_2 from 6 to 30° in the laboratory system. The analyser was a beryllium disk 30 mm. thick and 65 mm. in diameter. In most of the measurements the secondary scattered protons were registered in a solid angle of 2×10^{-3} sterad. with a single triple-counter telescope. The angular resolution of the

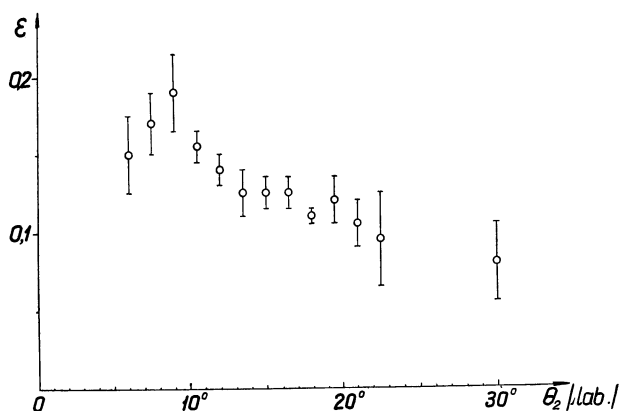

Fig. 4. Asymmetry ε | beam A | vs scattering angle θ_2 in Be.

* The experiments described in this section were made in 1954 ¹²⁾.

** Observation of nuclear disintegrations in G-5 photoplates irradiated in the beam A in the plane of the first scattering showed that there is an asymmetry equal to 0.11 ± 0.03 in forward emission of charged particles, in the tracks of which the grain density corresponded to proton energies above 200 Mev. Asymmetry was not discovered in irradiation of the plates in a plane perpendicular to the primary scattering ¹³⁾.

telescope was $\pm 1.5^\circ$. The proton registration threshold was taken as $0.85^\circ E_A \cdot \cos^2 \theta_2$, where E_A is the mean proton energy in the beam A. Charged particles from three processes were observed here, namely diffraction scattering, quasi-elastic p-p and non-exchange p-n collisions, as well as production of mesons with energies close to the peak-energy.

The averaged results of three independent series of measurements are given in fig. 4. Here also, as well as in the following diagrams and tables, standard deflections are shown based only on counting statistics. It will be seen that the angular distribution of the asymmetry can be described by a smooth curve with a peak at $\theta_2 = 9^\circ$.

The dependence of the asymmetry on the registration threshold was measured at an angle of $\theta_2 = 18^\circ$. The results obtained are given in Table I.

TABLE I

The value of the asymmetry ε (18°) at different registration thresholds **

Thickness of copper filter, cm.	0	15	20
Energy threshold Mev	30	435	530
ε (18°)	0.09 ± 0.01	0.11 ± 0.01	0.14 ± 0.02

It turned out that the asymmetry noticeably increased with increase in the thickness of the filter up to 20 cm. of Cu. When the filter thickness was 23.5 cm. of Cu, the counting rate of secondary scattered protons became negligible. From the results of measurements on spectra of charged pions emitted in p + Be collisions at 660 Mev energy ¹⁴⁾, it was calculated that at 565 Mev in a total flux of charged particles emitted at the angle of 18° and passing through a 20 cm. Cu thick filter, the contribution of charged pions did not exceed 2 per cent. It was no more than 5 per cent with a 15 cm. filter. On the basis of these estimates the asymmetry observed with 15 and 20 cm. Cu filters was interpreted as the asymmetry in proton scattering.

The increase in asymmetry with the increase in thickness of the filter can be explained :

- by a small admixture of diffraction-scattered protons among the charged particles,
- by the fact that the nuclear cascade and the pion production processes cause less asymmetry than the quasi-elastic p-p and non-exchange p-n collisions,
- by the difference in polarization along the spectrum of quasi-elastically scattered protons.

Since the polarization in quasi-elastic scattering in a wide angular interval increases with a decrease of the angle (see section 7) it should be expected that in quasi-elastic scattering, protons emitted at the given angle with an energy greater than the average will be polarized somewhat more strongly.

Disregarding the influence of the proton energy loss and assuming that, both in the primary and in the secondary proton scattering, at the angle of 18° the same quasi-elastic p-p and non-exchange p-n collisions are the most important, it may be calculated from the relation

$$\epsilon = P_1(\theta_1) \cdot P_2(\theta_2),$$

(where $P_1(\theta_1)$ and $P_2(\theta_2)$ are the polarizations in the first and second scatterings respectively), that for $\theta_1 = \theta_2$, using data on polarization of the beam from measurements with a 15 cm. Cu filter, $P_1(18^\circ) = \sqrt{\epsilon(18^\circ)} = (33 \pm 2)\%$. From the resulting value of $P_1(18^\circ)$ it follows that the polarization (60 ± 10) per cent is in agreement with the value of the asymmetry $\epsilon = 0,19 \pm 0,03$ in the peak of the angular distribution at the angle of $\theta_2 = 9^\circ$. It is perfectly clear that the increase in the relative role of the diffraction scattering in the processes observed is one of the main causes of the increase of asymmetry with a decrease of the scattering angle.

5. Polarization of 635 Mev protons

To determine the angular dependence of the asymmetry of secondary scattered protons in the beam B, two telescopes were used, placed one after the other, and connected in coincidence. The telescope closest to the analyser comprised three, and the farther one comprised two scintillation counters. The coincidences in the first telescope and the intertelescope coincidences were registered simultaneously. A copper filter was placed between the counters so that the first telescope registration threshold

was at 230 Mev, while the registration threshold for the set of telescopes changed with the scattering angle as $E_B \cos^2 \theta_2$, where $E_B = 635$ Mev is the mean proton energy in the beam B. In these conditions five-fold coincidences were obtained almost entirely with diffraction scattered protons. By the introduction of a delay in the electron circuit it was found that along the entire range of observation angles of the secondary scattered protons the number of intertelescope random coincidences did not exceed 1 per cent of the total number registered with the analyser in the beam. In the region of angles 9° to 50° measurements were made with an angular resolution of ± 2°; at smaller angles they were made with an angular resolution of ± 1°. The scattered protons were observed in the solid angle of 2×10^{-3} and 6×10^{-4} sterad. respectively.

The results of measurements on the angular dependence of the asymmetry are shown in fig. 5, the white circles representing the asymmetry values obtained from observations of the five-fold coincidences, the black circles representing the asymmetry values calculated from the readings of the telescope closest to the analyser. As can be seen, the asymmetry of the long-range particles steeply increases as the scattering angle increases, reaches the peak value of 0.36 ± 0.04 at $\theta_2 = 7^\circ$ and then smoothly decreases, right down to 30°. As for the asymmetry of fast charged particles, it is found to exist up to 42° and is almost constant in the region of angles 7° to 20°.

Data on the changes in asymmetry when the registration threshold is increased were obtained in measurements with filters of various thicknesses set up between the telescopes. The results of these measurements are shown in Table II.

TABLE II

Dependence of the asymmetry on the registration threshold at the angles of 9°, 12° and 18°

Registration threshold, Mev	$\epsilon(9^\circ)$	$\epsilon(12^\circ)$	$\epsilon(18^\circ)$
160			0.06 ± 0.03
190			0.08 ± 0.03
230	0.11 ± 0.01	0.11 ± 0.01	0.10 ± 0.01
480			0.12 ± 0.02
565		0.17 ± 0.05	
580			0.23 ± 0.03
600	0.11 ± 0.04	0.16 ± 0.07	
610		0.31 ± 0.03	
620	0.33 ± 0.03		

The fact that at small scattering angles the asymmetry turned out to be much greater for the particles of maximum range is a definite proof of greater polarization of the diffraction-scattered protons, as compared with particles emitted as the result of collisions with individual nucleons in the nuclei.

According to data from five-fold coincidence observations, the asymmetry at the angle $\theta_2 = \theta_1 = 9^\circ$ was found to be 0.33 ± 0.03 . From this it follows that the proton

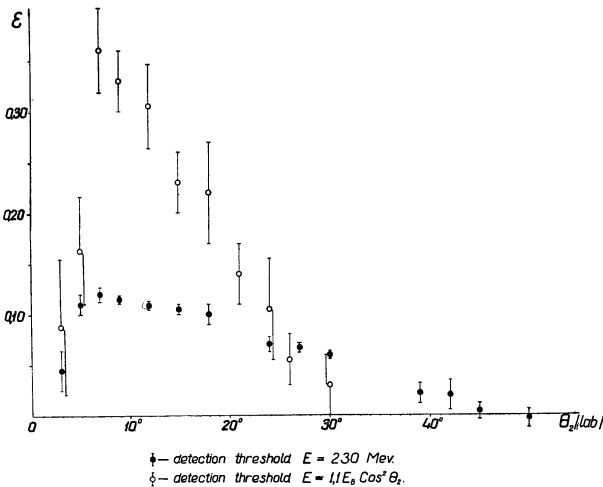

Fig. 5. Asymmetry ϵ (beam B) vs scattering angle θ_2 in Be.

polarization in the beam B is 58 ± 3 per cent. The maximum value of $\varepsilon = 0.36 \pm 0.04$ found at the angle of 7° agrees with the polarization (62 ± 10) per cent. Actually, the polarization of protons scattered by diffraction on beryllium is, evidently, still higher, since in these experiments the total separation of quasi-elastically scattered protons could not be achieved. It should be noted that at $\theta_2 = 9^\circ$, the contribution of charged pions to the number of five-fold coincidences did not exceed 1 per cent.

Similar experiments on secondary proton scattering on beryllium at lower energies are described in ^{4-6,15}. Values of the polarization of diffraction scattered protons found in these works corresponding to the maximum values of the observed asymmetry, together with the results of

the present experiments are given in fig. 6 in relation to the primary scattered proton energy. It is noteworthy that the polarization of protons scattered by diffraction on beryllium does not change noticeably with an energy increase from 300 to 635 Mev.

6. Secondary scattering of polarized protons on C, Al, Pb and Be nuclei

Asymmetry measurements at $\theta_2 = 9^\circ$ for these nuclei were made in the same conditions as those described in the previous section. The beryllium analyser was replaced by a carbon, aluminium, lead or bismuth scatterer with an equivalent stopping power. The results of these measurements are shown in Table III.

TABLE III
Asymmetry values in secondary 635 Mev proton scattering on Be, C, Al, Pb and Bi

	Be	C	Al	Pb	Bi
(E < 620 Mev)	0.33 ± 0.03	0.32 ± 0.04	0.25 ± 0.05	0.34 ± 0.07	0.30 ± 0.08
(E < 230 Mev)	0.11 ± 0.01	0.13 ± 0.02	0.03 ± 0.01	0.08 ± 0.02	0.07 ± 0.02

It is essential that very similar asymmetry values at the 620 Mev registration threshold were obtained for all the investigated nuclei when diffraction proton scattering was mainly observed. Asymmetry in the emission of charged particles with energies above 230 Mev decreased insignificantly with increase in the size of the scattering nucleus. It is best to refrain from discussing the reasons for the exception of aluminium to this rule until there are enough data on the angular dependence of the asymmetry in proton scattering on this nucleus.

7. Asymmetry in quasi-elastic p-p scattering at 635 Mev *

The elementary events in quasi-elastic p-p collisions were observed with two conjugated telescopes described in ¹⁵. The proton scattering was observed in a solid angle of 1.7×10^{-2} sterad., cut out by the surface of the first crystal, closest to the analyser, in the determining telescope, with a 35×35 mm. cross-section. The second and third crystals in this telescope had 45×45 and 50×50 mm. cross-sections. The determining telescope registration threshold was 150 Mev. The conjugated telescope, comprised of 52×52 and 60×60 mm. cross-section crystals cut out a solid angle of 4.7×10^{-2} sterad. The intertelescope coincidence circuit was chosen to have a resolving time of 5×10^{-8} sec. The angular resolution of the entire registering device was about $\pm 2^\circ$. A beryllium disk, 60 mm. in diameter and 30 mm. thick was used as an analyser, as usual. The diameter of the beam B at the analyser was 40 mm. For measuring the asymmetry

the telescopes were arranged in the primary scattering plane on both sides of the beam at angles θ_2 and θ_2' , bound by the relation $\text{ctg}\theta_2 \times \text{ctg}\theta_2' = 1 + E/2Mc^2$ where E is the kinetic energy of the incident proton, and Mc^2 is the proton rest energy. Data on the insignificant contribution of inelastic p-p and p-n collisions to the counting rate of the quasi-elastic p-p scattering events were

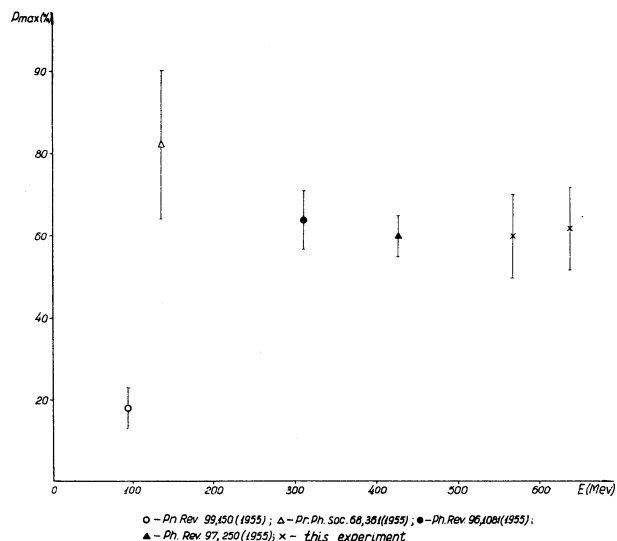

Fig. 6. Maximum polarization of protons diffractively scattered on Be vs energy.

* In these experiments L. B. Parfenov participated.

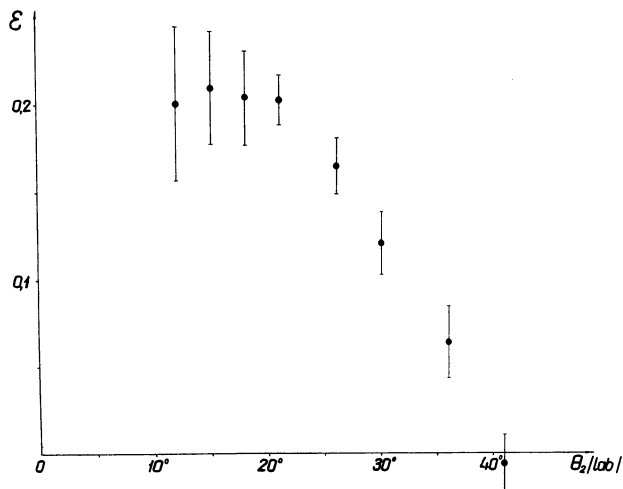

Fig. 7. Asymmetry ϵ (beam B) vs scattering angle θ_2 for quasi-elastic p-p scattering in Be.

obtained in experiments in which all along the range of observation angles, intertelescope coincidences were registered, the telescopes being adjusted to each other at angles not corresponding to the stated relation.

The values of the asymmetry ϵ obtained as a function of the scattering angle θ_2 in the laboratory system are given in fig. 7. Taking the polarization of the primary scattering of the beam as 0.58 ± 0.03 with these data we can find the polarization $P_{\langle pp \rangle}$ in the quasi-elastic p-p scattering on Be from the relation $E = 0.58 P_{\langle pp \rangle}$. For an angle of 40° in the c.m.s. ($\theta_2 = 21^\circ$), the polarization proved to be 0.35 ± 0.04 .

The asymmetry of the free p-p scattering was also measured in this work at the angle of $\theta_2 = 21^\circ$. Polyethylene and graphite scatterers equivalent to the number of carbon nuclei served as analysers. The hydrogen effect was found by the subtraction method. It was established that the asymmetry was 0.25 ± 0.07 to which corresponds a polarization $P = 0.43 \pm 0.04$. As these results show, the proton polarization at 635 Mev in quasi-elastic p-p scattering is only a little less than that in free p-p scattering.

Similar experiments in measuring asymmetry in the quasi-elastic p-p scattering on Be were formerly made with 285 Mev protons¹⁷⁾. According to the data of this work, for an angle of 40° in the c.m. system the polarization in quasi-elastic p-p scattering was $P_{\langle pp \rangle} = 0.15 \pm 0.04$, while polarization in free p-p scattering under the same conditions is ~ 0.42 ²⁾.

A comparison of the experimental data presented here shows that with an energy increase from 285 to 635 Mev, firstly, the difference in degree of polarization in quasi-elastic and free elastic p-p scattering is decreased to a great extent and, secondly, that the polarization in free p-p scattering does not change noticeably.

8. Conclusion

In summing up the following conclusions can be drawn from the experimental results obtained :

1. At 660 Mev, proton polarization is produced both in diffraction scattering and in quasi-elastic collisions.
2. The polarization of diffraction-scattered protons is considerably greater than that of protons having undergone quasi-elastic and inelastic collisions.
3. The asymmetry values found at the angle of 9° in the scattering of protons with an energy above 620 Mev on Be, C, Al, Pb and Bi nuclei turned out to be equal within the limits of experimental errors.
4. A comparison of available data on the double scattering of protons on beryllium shows that :
 - (a) the maximum polarization value of diffraction-scattered protons does not change noticeably with an energy increase from 300 to 635 Mev and is at least 60 per cent;
 - (b) Proton polarization in quasi-elastic p-p scattering more than doubles with an energy increase from 285 to 635 Mev, and reaches a value only a little less than the polarization values in free p-p scattering.
5. It may be suspected that proton polarization in free p-p scattering has about the same value both at 300 and at 625 Mev, but data obtained on this so far are still meagre.

LIST OF REFERENCES

1. Oxley, C. L., Cartwright, W. F. and Rouvina, J. Double scattering of high-energy protons. *Phys. Rev.*, *93*, p. 806-16, 1954.
2. Chamberlain, O. et al. Experiments with high-energy polarized protons. *Phys. Rev.*, *93*, p. 1430-1, 1954.
3. Marshall, J., Marshall, L. and de Carvalho, H. G. Polarization by p-p collision at 310 Mev. *Phys. Rev.*, *93*, p. 1431, 1954.
4. de Carvalho, H. G., Marshall, J. and Marshall, L. Polarization of protons by scattering from beryllium. *Phys. Rev.*, *96*, p. 1081-5, 1954.
5. Heiberg, E. et al. Slowing down of polarized protons. *Phys. Rev.*, *97*, p. 250-1, 1955.
6. Dickson, J. M., Rose, B. and Salter, D. C. Elastic scattering of polarized protons from complex nuclei. *Proc. phys. Soc., Lond. A*, *68*, p. 361-8, 1955.
7. Fermi, E. Polarization of high energy protons scattered by nuclei. *Nuov. Cim.*, *11*, p. 407-11, 1954.
8. Snow, G. A., Sternheimer, R. M. and Yang, C.N. Polarization of nucleons elastically scattered from nuclei. *Phys. Rev.*, *94*, p. 1073-4, 1954.

9. Malenka, B. J. Polarization in high-energy elastic nucleon-nucleon scattering. *Phys. Rev.*, 95, p. 522-6, 1954.
10. Heckrotte, W. and Lepore, J. V. Polarization of nucleons elastically scattered from nuclei. *Phys. Rev.*, 95, p. 1109-10, 1954.
11. Meshcheriakov, M. G. et al. *RINP*, 1956.
12. Stoletov, G. D. and Nurushev, S. B. *RINP*, 1954.
13. Grigoriev, E. L. Detection of polarization of beams of fast particles by means of nuclear photo-emulsions. *Zh. eksper. teor. Fiz., SSSR*, 28, p. 761, 1955.
14. Meshcheriakov, M. G. et al. *Zh. eksper. teor. Fiz., SSSR*. (in the press.)
15. Strauch, K. Double scattering experiment with 96 Mev protons. *Phys. Rev.*, 99, p. 150-4, 1955.
16. Meshcheriakov, M. G., Bogachev, N. P., Neganov, B. S. and Piskarev, E. V. (Elastic scattering of 460 Mev protons by protons.) *Doklady Akad. Nauk SSSR*, 99, p. 955-8, 1954.
17. Donaldson, R. E. and Bradner, H. Asymmetry in p-n and p-p scattering from targets bombarded with 285 Mev polarized protons. *Phys. Rev.*, 99, p. 892-5, 1955.

DISCUSSION

A. Roberts: The curves shown for diffraction scattering include both elastic and inelastic scattering, and are predominantly elastic only in the first diffraction maximum and below. Above this angle the elastic and inelastic angular distributions are quite different, and therefore the shape shown in the figures is not likely to be significant outside the first diffraction maximum at $8-9^\circ$. At 660 Mev

the separation of elastic and inelastic scattering is extremely difficult.

M. G. Meshcheriakov agreed with Roberts on the difficulty to distinguish elastic and inelastic scattering. Great care had to be exercised and among other things the energy spectrum of the produced pions was investigated.