

LHC Crab Cavities *

I. Ben-Zvi, R. Calaga, BNL, Upton, USA

R. Assmann, O. Brüning, O. Brunner, E. Ciapala, U. Dorda, R. Garoby, J. P. Koutchouk,

T. Linnecar, R. Tomás, J. Tuckmantel, Y. Sun, F. Zimmerman, CERN, Switzerland

G. Burt, B. Hall, CI/LU; P. A. McIntosh, DL/ASTeC, UK

T. Peterson, N. Solyak, V. Yakovlev, FNAL, Batavia, USA

B. Rimmer, H. Wang, JLAB, Newport News, USA

K. Hosayama, N. Kota, A. Morita, Y. Morita, K. Oide, KEK, Tsukuba, Japan

A. Seryi, Z. Li, L. Xiao, SLAC, Menlo Park, USA

Abstract

A small angle crab compensation (~ 0.5 mrad) is foreseen to improve the LHC luminosity independently of the IR upgrade paths to enhance the luminosity of the LHC by 15% for the nominal and 43-62% for phase II upgrade scenarios while naturally providing a luminosity leveling knob. A joint collaboration initiated by LARP and CARE-HHH has resulted in a global collaboration to establish a feasibility study for crab crossing in the LHC. This collaboration is carrying out an intense R&D program to design and fabricate superconducting RF (SRF) prototype cavity at 800 MHz to test several SRF limits in the deflecting mode. If the prototype is installed in the LHC, it can be used for a first demonstration of crab crossing in hadron beams and understand potential emittance growth mechanisms due to crab cavities. This paper discusses options and limits for a safe demonstration experiment.

INTRODUCTION

The proposed crab crossing scheme for the LHC phase I & II upgrade aims to extend the luminosity reach by approximately 43-62% for $\beta^* = 25$ cm and even larger for smaller β^* [1, 2, 3, 4]. Fig 1 shows a plot of the luminosity gain as a function of reduced β^* for the LHC with and without crab crossing. The effect of crab cavities become clearly evident when the curves with crab crossing is compared to the red curve resulting from an upgrade without crab crossing. The complete recovery of the geometric loss is not realized due to the finite RF wavelength in the crab cavities which can be characterized into a RF reduction factor [5] This reduction factor is small for small crossing angles (< 1 mrad) but it may become significant for larger crossing angles at higher frequencies [4]. In addition the cavity voltage provides a natural luminosity leveling knob highly desired by the physics experiments to maintain a constant luminosity during a physics store and improve the overall lifetime.

This large potential has initiated an intense R&D program to establish a proof of principle in time frame of the

* We acknowledge the support of the European Community-Research Infrastructure Activity under the FP6 "Structuring the European Research Area" program (CARE, contract number RII3-CT-2003-506395). This work was partly performed under the auspices of the US Department of Energy

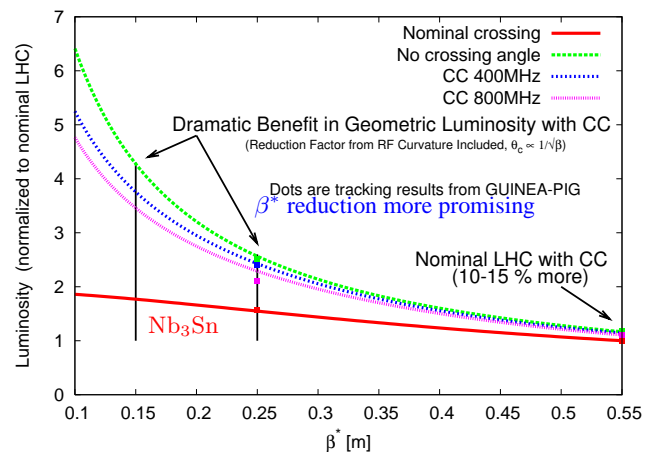

Figure 1: Luminosity scope showing the dramatic benefit of the crab compensation at smaller β^* . Note that the effect of RF curvature of the crab cavities is included. The dots represent tracking results from GUINEA-PIG [6].

LHC phase I upgrade (circa 2013). The first prototype test in the LHC is vital to realize and exploit the concept of crab crossing for the future upgrades of the LHC (see section and Appendix B). The time line of this R&D study is depicted in Fig. 2. The initial study began under CARE-HHH & LARP networks which evolved into a global collaboration including several institutions around the world. Superconducting deflecting structures and associated challenges have gained considerable attention in the recent years due to their application in hadron colliders, light sources, B-factories and future electron-ion colliders. Some relevant parameters of the LHC for both nominal and upgrade options are listed in Table 1.

Due to several technical and physical constraints posed by the LHC and the available RF technology, the first prototype test will utilize a reduced number of RF structures at 800 MHz in a special global crab scheme. This prototype test will not only demonstrate the first crab crossing in hadron colliders, but: The prototype test among many tests will probe:

- Highest RF surface field limits in the deflecting mode to reach the nominal 2.5 MV kick and beyond.
- Achieve very strong LOM-HOM damping with a

Table 1: Some relevant parameters for the LHC nominal and upgrade lattices.

Parameter	Unit	Nominal	Phase I upgrade
Circumference	[km]	27	27
Beam Energy	[TeV]	7	7
Number of Bunches	n_b	2808	2808
Protons/Bunch	$[10^{11}]$	1.15	1.7
Average current	[Amps]	0.58	0.86
Bunch Spacing	[ns]	25	25
Norm Emmit: ϵ_n	$[\mu\text{m}]$	3.75	3.75
Bunch Length, σ_z (rms)	[cm]	7.55	7.55
IP _{1,5} β^*	[m]	0.55	0.25
Betatron Tunes	-	{64.31, 59.32}	{64.31, 59.32}
Beam-Beam Parameter, ξ	per/ip	0.003	0.005
Effective Crossing Angle: θ_c	$[\mu\text{rad}]$	285	445
Piwinski Parameter	$\frac{\theta_c \sigma_z}{2\sigma^*}$	0.64	0.75
Main RF Frequency	[MHZ]	400.79	400.79
Harmonic Number		35640	35640

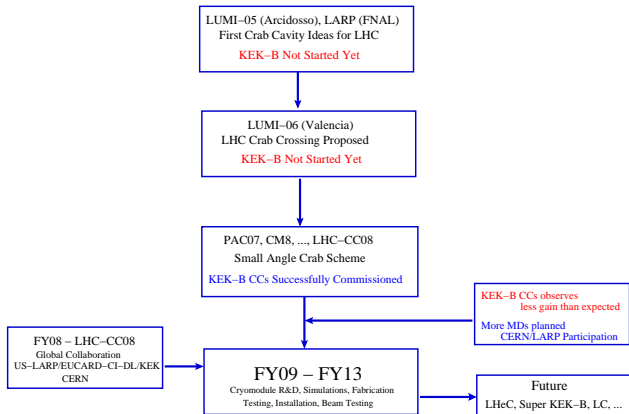

Figure 2: Timeline of the crab crossing proposal for the LHC from 2005 to present.

complex configuration of couplers in superconducting environment to minimize the impedance of the cavities and alleviate beam instabilities.

- Engineer a compact cryomodule to adapt to the tight LHC tunnel constraints. Special cryogenic pumping within the cryostat maybe required to operate at 2 K if needed.
- First demonstration of crab crossing in a high energy hadron collider
- Measure RF phase noise and corresponding feedback mechanisms to determine the stability thresholds in the presence of the crab cavity.
- Measure emittance evolution, luminosity increase, lifetime during injection, energy ramp and collision energies.

- Measure collimation efficiency in the presence of a global crabbed beam and associated impedance to determine an optimized configuration.
- Test the feasibility of luminosity leveling in conjunction with experiments.

KEK-B PERFORMANCE

The successful commissioning of crab crossing in KEK-B was the first ever demonstration in a very high current $e^+ - e^-$ collider operating in an unprecedented beam-beam parameter regime. This was a critical step in establishing a road map towards the LHC crab cavities. Over a period of 10 years, the KEK-B team overcame several technical challenges to fabricate and commission the RF structure. The complex coupler assembly consisting of a movable beam pipe coaxial antenna (see Fig. 3) in superconducting environment proved to be a major challenge. Some initial problems with the mechanical assembly for the LER coaxial coupler was fixed using additional support but the maximum voltage reach of the LER cavity was below the design specification.

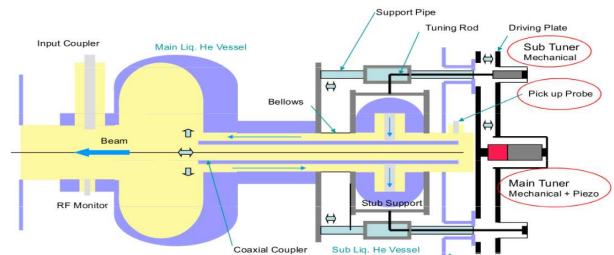

Figure 3: Schematic of KEK-B crab cavity (courtesy Y. Morita).

The beam commissioning of two cavities (one per ring) lead to several crab cavity specific experiments that are either partially or directly relevant to the LHC. It should be noted that KEK-B operates at a Pwinski angle very similar to that of the LHC and beam currents and beam-beam parameter exceeding the LHC specifications. However, the electrons provide natural synchrotron damping which makes it less sensitive to external forces with a larger time scale than the damping time. The cavity trip rate was unusually high (approximately 1-3 per day) for the two cavities at different stages of operations which needs considerable improvement for reliable operation. The cavity trip at present results in a beam abort which is disruptive for the experiments but a scheme to restart the cavity without beam abort is under investigation [7]. The turn-around time in the LHC can be 5-10 hrs [8]. Therefore, cavity trip rate is one of the most critical items for the LHC cavities and has to be controlled to an extremely small level.

Both cavities in KEK-B reached high current physics operation (1.62/0.9 Amps) without any serious instabilities. The LER cavity was operated below the design voltage due to degradation of voltage and a remedy by warming up the cavity and reconditioning during a shutdown period proved to be ineffective. The magnetic optics was changed to compensate for the lower voltage which subsequently resulted in aperture limit. A new optics design should remedy the aperture problem with the appropriate β -function at the crab cavity. Fig. 4 shows KEK-B physics run with luminosities and lifetimes with crab crossing over a 8 month period. The HER and LER currents were 1.62 A and 0.9 A respectively.

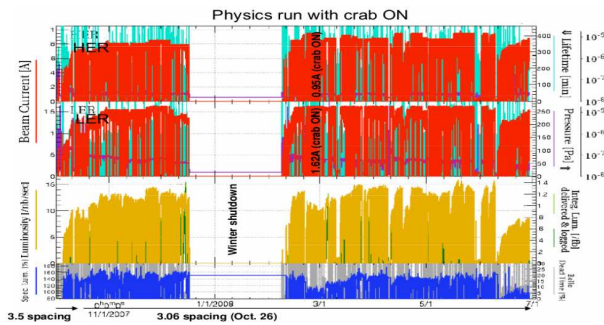

Figure 4: KEK-B physics run with luminosities and lifetimes over a 8 month period. The crab crossing was implemented with high currents 1.62/0.9 A for the HER and LER respectively (courtesy Y. Morita).

Although the crab cavities were commissioned and in daily use, the luminosity increase predicted by simulations at high currents was not realized. Fig. 5 shows the systematic degradation of both luminosity and lifetime with increasing currents. An asymmetry in the beam lifetime with positive and negative offsets is observed which is not understood. Although, the root cause of luminosity slope is not understood, experiments using different bunch spac-

ing concluded to being a single bunch effect. With several experimental observations and corresponding simulations, it was concluded that the machine optics coupled with dynamic beam-beam could be the main reason for such an effect. The LHC will operate at beam-beam parameter of approximately a factor of 5-10 smaller than KEK-B, hence making such effects a non concern [9]. In addition LHC has round beams at the IP making it significantly less sensitive to small optics errors compared to KEK-B.

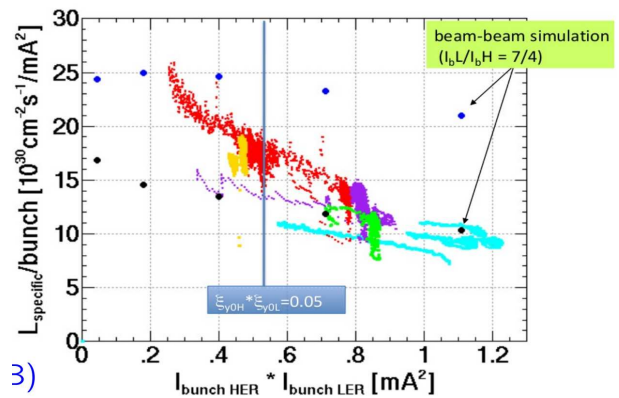

Figure 5: KEK-B physics run with luminosities and lifetimes over a 8 month period. The crab crossing was implemented with high currents 1.62/0.9 A for the HER and LER respectively [7].

LHC SCENARIOS

The luminosity increase solely from crab cavities is expected to be in the range of 12-18% for the nominal LHC ($\beta^* = 55$ cm) and 43-62% for the upgrade with $\beta^* = 25$ cm for cavity frequencies of 800-400 MHz respectively. Due to space constraints and technical ease, a global scheme at the LHC is considered as the best choice for the first test of crab crossing in hadron colliders. At present only the IR4 region, currently hosting the LHC main RF, has a special dog-leg to horizontally separate the two beam lines to 42 cm. Elsewhere, the beam-to-beam separation is only 19 cm which makes it impossible to place 800 MHz RF structures. The 800 MHz upper limit was chosen as the best compromise between the LHC bunch length and transverse dimensions of the cavity.

In this scheme the cavities are placed in the accelerating RF section (IR4, see Fig. 6) to provide head-on collision at one of the interaction points in the LHC (IP₁ or IP₅). Currently the space available in IR4 is reserved for capture cavities which maybe required for high intensities [10]. However, a scheme to incorporate both the crab cryomodule and the capture cavities is under investigation. The luminosity increase may only be marginal (~10%) with nominal optics ($\beta^* = 55$ cm) and technical limits on the available number of cavities and the desired crab optics may limit this reach. Therefore, scenarios specific to the pro-

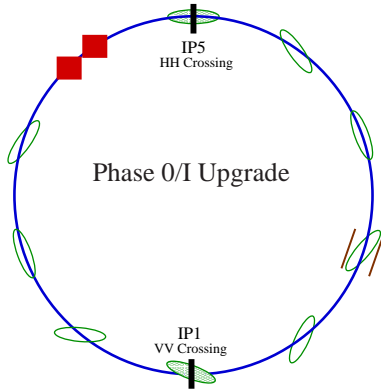

Figure 6: LHC crab crossing phase 0/I scenario anticipated in the time frame of the phase I upgrade.

prototype test to enhance the effect of the crab crossing using a special machine setup will be required to unambiguously prove the benefit of larger than 10% which is discussed in section . The subsequent step after the prototype demonstration will closely follow the upgrade path envisioned for phase II of the LHC which will entail a complete redesign of the interaction region. Two of the proposed paths (early separation and full crab crossing) require four crab structures (see Fig. 7) placed in the interaction region to steer the beam into head-on collisions. After the initial proof of principle during the phase I upgrade, this upgrade is expected to realize the full potential of crab crossing and increase the luminosity upto 62% for 25 cm β^* or larger for decreasing β^* . In addition the natural luminosity leveling possible with crab cavities will aid in providing a long lifetime with almost constant luminosity which is highly desirable by the experiments.

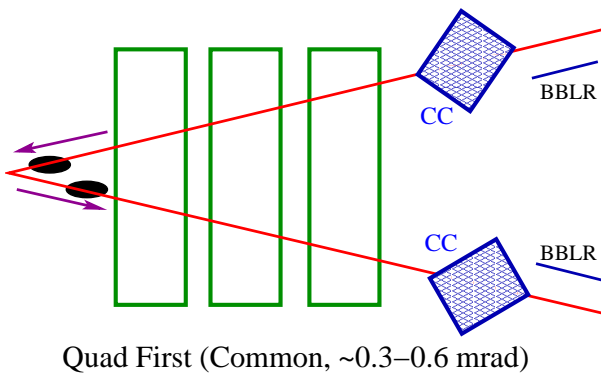

Figure 7: LHC crab crossing phase II scenario anticipated in the time frame of the phase II upgrade. Two crab structures are shown on one side of IP to crab and anti-crab the beam in the IR region.

OPTICS & FLEXIBILITY

Two locations of 3-5m length along with the optics functions as depicted in Fig. 8 have been identified as potential locations that can be used unless the capture cavities originally foreseen for these points become essential for LHC operation [10]. At present a solution to accommodate both the capture cavities and the crab cryomodule on the beam line. IR4 also provides another significant advantage as the existing RF infrastructure can be adapted to the crab cavities including the cryostat design, waveguides, power sources, cryogenics, water cooling and RF controls while conforming to LHC technical and mechanical specifications.

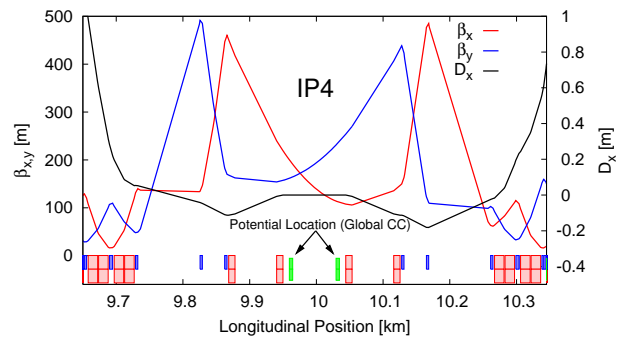

Figure 8: Nominal optics and magnetic elements in the IR4 region of the LHC. The two green blocks represent the potential locations (~ 10 m) for cavities in the global scheme.

As seen in Fig. 8 the β -functions at these locations are approximately 100-200 m and cannot be increased beyond 300 m with current magnet setup due to aperture constraints. This optics would require in excess of 9 MV kick which is impractical both from both technical aspect and physical available space for the prototype test. A simple solution proposed by K. Oide to invert the polarity of the quadrupole limiting the aperture can easily increase the β_{CC} further [2]. Therefore, a special optics compatible with 25-55 cm β^* and the available 2.5 MV kick from a single cavity is underway [11].

The transverse kick voltage required is

$$V_{crab} = \frac{2cE_0 \tan(\theta_c/2) \sin(\mu_x/2)}{\omega_{RF} \sqrt{\beta_{crab} \beta^*} \cos(\psi_{cc \rightarrow ip}^x - \mu_x/2)} \quad (1)$$

where E_0 is the beam energy, ω_{RF} is the RF frequency of the cavity, β_{crab} and β^* are the beta-functions at the cavity and the IP respectively, $\psi_{cc \rightarrow ip}^x$ is the phase advance from the cavity to the IP and μ_x is the betatron tune. Therefore, phase advance between the crab cavity and the IP is an important parameter. Fig. 9 presents the tuning range of the betatron phase advance in the nominal LHC. The figure shows the horizontal and vertical phase advances per arc cell, respectively. The red line delimits the accessible values of the phase advances as constrained by aperture limitations and the nominal closed orbit and aperture

assumptions for the LHC within the cell. A tighter aperture cut would yield the area within the blue line. A wide range for phase advance tunability is available when using the usual aperture assumptions for the LHC thus providing good margin for operation and the cavity voltage.

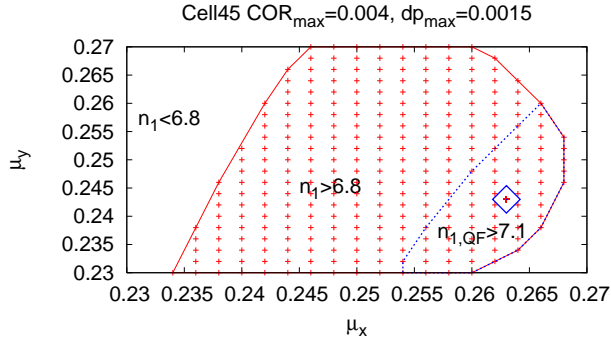

Figure 9: Tuning range of the LHC betatron phase advance. The horizontal and vertical axes of the plot are the horizontal and vertical phase advances per arc cell with the LHC operating point marked in a square.

For the phase II upgrade the interaction region scenarios are under study for several years. A new proposal to push the D_2 magnet away from the IP to improve matching of the IR section and the aperture of the long straight section [12]. This change is naturally favorable for crab cavity upgrade as the additional space between the D_1 and D_2 magnets is available for the cavities and other instrumentation. In the crab crossing scenario, two additional magnets D_{11} and D_{12} (see Fig. 10) are placed as easy add-on to maximize the space between the beams to about 27 cm separation for approximately 20 m longitudinally. Beam pipe apertures and magnet parameters for the scheme proposed in Fig. 10 are listed in Table 2. Although optimization of the magnet parameters are not final the initial fields and apertures well within the reach of the existing NbTi technology.

Table 2: Beam pipe apertures and magnet requirements in the crab crossing scenario including the additional D_{11} and D_{12} magnets.

Magnet	Ap-H [mm]	Ap-V [mm]	Tesla	L [m]
D_1	134	110	7	10
D_{11}	106	70	7	10
D_{12}	78	60	4	10
D_2	69	53	3.85	10

Since the β -functions at the IR region are quite large (~ 4 km), the required voltages for the phase II upgrade are quite similar to that required in the phase I prototype test. Table shows a comparison between upgrade optics and the nominal optics functions and the corresponding

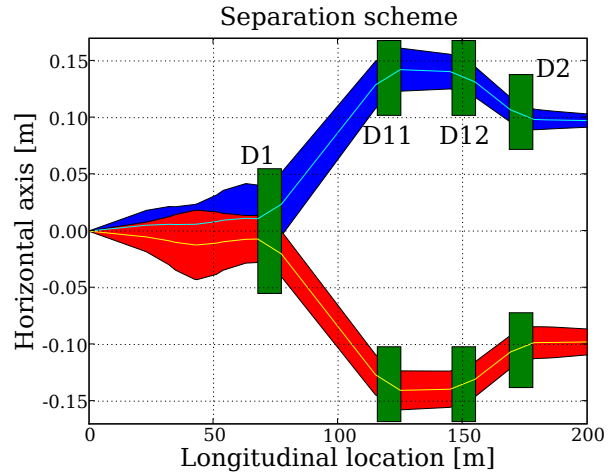

Figure 10: Schematic of the crab crossing scheme for the phase II upgrade of the LHC. The transverse separation with the aid of D_{11} and D_{12} magnets can be upto 27 cm for a longitudinal space of 20 m.

Table 3: Comparison between the nominal and upgrade optics functions and the corresponding voltages required to compensate the crossing angles at the interaction point.

Par	Unit	Nominal [G]	Upgrade [L]
$IP_{\{1,5\}} \beta^*$	[cm]	55 (25)	25 ($15_{ES,CC}$)
θ_C	[mrad]	0.3	0.44 (0.58)
β_{CC}	[km]	0.8	3.0
CC Volt	[MV]	4.7 (10.5)	3.5 (≤ 5)

voltages required. Tracking studies in the LHC indicate that crab cavities enhance synchro-betatron resonances, in particular 3rd, 5th, 6th, 7th Q_s sidebands, which may have an impact on particle stability. Some of the dangerous synchrobetatron resonances could be $Q_x - Q_y + 6Q_s$, $Q_x + 2Q_y + 30Q_s$, etc... Detailed simulations are underway to investigate the effects of these sidebands on long term stability and beam lifetime. Preliminary simulations indicate that global crab crossing scenario reduces the dynamic aperture but is still well above the typical 12σ level (see Table 4).

PROTOTYPE CAVITY & COUPLERS

The cavity geometry first originated from an initial 400 MHz design via a geometrical parameter scan to reach semi-optimal RF characteristics for the deflecting mode. After scaling to 800 MHz, additional optimizations were performed on the 800 MHz cavity to arrive at the two designs shown in Fig. 11. A third design was carried by the UK group to reach lower surface fields with larger apertures. In this design the beam pipe aperture is larger than the cavity iris to match the impedances in dipole cavity and

Table 4: Dynamic aperture table for both 400 MHz and 800 MHz crab cavities compared to the nominal LHC and low beta upgrade option. The DA is calculated based on survival beyond the 10^5 turns.

error= $\pm 0.5\sigma$	Nominal LHC	LowBeta
No CC	16.0	15.9
Local 400 MHz	14.1	15.5
Local 800 MHz	14.7	16.0
Global 400 MHz	12.1	14.3
Global 800 MHz	13.0	12.4
$\Delta\phi_{CC \rightarrow IP}$	0.278	0.239

increase the voltage [14]. The optimized geometric and the corresponding RF parameters are shown in Table 5 and Table 6 respectively. The large aperture was fixed based on the local scheme proposed in Fig. 10 since phase II upgrade may use the same elliptical design if an alternate compact design is not available.

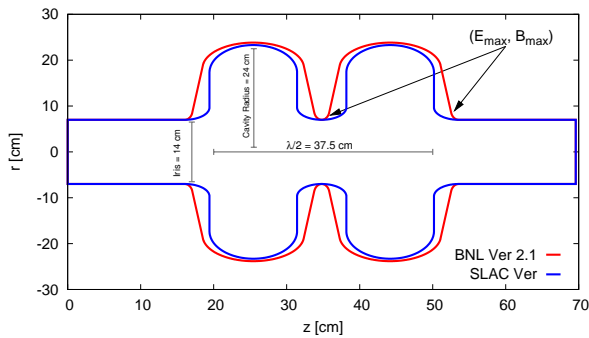

Figure 11: 800 MHz two-cell cavity from crab crossing for the LHC. An alternate version optimized by SLAC group (blue, geometrical parameters courtesy L. Xiao, Z. Li) achieves lower surface fields.

Typically, a finite wall angle of 6° or larger is preferred for cavity treatment. Fine tuning may be required to meet the final requirements related to surface fields, multipacting and coupler geometries.

The LHC impedance is dominated by the numerous collimators but additional impedance (both narrow band and broadband) from sources like crab cavities need to be minimized. It is estimated that single and coupled-bunch longitudinal modes above 2 GHz will be Landau-damped due to the frequency spread of synchrotron oscillations. Tolerances can be set by estimating the impedance requirements given by [15, 16, 17],

$$R_{sh,L} < \frac{\eta E}{e I_0 \beta^2} \left(\frac{\Delta}{E} \right)^2 \frac{\Delta \omega_s}{\omega_s} \frac{F}{f_0 \tau} G(f_r \tau) \quad (2)$$

$$\text{Im} \left(\frac{Z}{n} \right) < \frac{\eta E}{e I_b \beta^2} \left(\frac{\Delta}{E} \right)^2 \frac{\Delta \omega_s}{\omega_s} f_0 \tau. \quad (3)$$

Table 5: Three optimized geometries for two-cell 800 MHz LHC crab cavity geometry.

Parameter	Crab Cavity		
	BNL v2.2	SLAC	CI/DL
Frequency [MHz]	800	800	800
Iris Radius, R_{iris} [cm]	7.0	7.0	7.0
Beam Pipe Radius [cm]	7.0	7.0	9.0
Wall Angle, α [deg]	6.0	0.0	-
Iris Ellipse, $r = \frac{b}{a}$	2.0	0.8	1.0
Eq. Ellipse, $R = \frac{B}{A}$	0.8	1.0	1.0
Cav. wall to iris, d [cm]	1.0	3.375	-
$\frac{1}{2}$ Cell, $L = \frac{\lambda \beta}{4}$ [cm]	9.375	9.375	9.375
Eq. Height, D [cm]	23.8	23.3	23.1
Cavity Beta, $\beta = v/c$	1.0	1.0	1.0

Table 6: RF characteristics of the two geometries for a kick gradient of $B_{kick} = 6.6$ MV/m ($L_{active} \sim 37.5$ cm).

Parameter	Unit	Crab Cavity	
		BNL v2.2	SLAC
E_{peak}	MV/m	22	30
B_{peak}	mT	103	87
R/Q_{\perp}	Ω	112	118
$k_{ }$	V/pC	0.54	0.43
k_{\perp}	V/pC/m	2.635	2.164

In the transverse plane the natural frequency spread, chromaticity, bunch-by-bunch transverse damper and Landau octupoles should also damp potentially unstable modes above 2 GHz. The stability limit from Landau octupoles at 7 TeV can be formulated in terms of a maximum limit on tune shifts ($\text{Re}\{\Delta Q\} < 3 \times 10^{-4}$, $\text{Im}\{\Delta Q\} < 1 \times 10^{-4}$). Pessimistically assuming that the sampling frequency falls on the resonance,

$$R_{sh,T} \ll \frac{Z_0 C \gamma}{r_0 M N_b \beta} |\text{Im}\{\Delta Q\}|_{max} \quad (4)$$

Table 7 lists the corresponding tolerances.

Table 7: Impedance tolerances estimates.

Parameter	Unit	Longitudinal		Trans
		Inj	Top	
Coup bunch, R_{sh}	k Ω	137	196	$\ll 2$ M Ω /m
Coup bunch, Q_{ext}		< 200		-
Broadband, $\text{Im}\{Z/n\}$	Ω	0.24	0.15	-

To reach these tolerances of mode quality factors, three designs have been proposed to strongly damp the lower order TM_{010} , same order TM_{110} and the rest of higher order

modes. Fig. 12 shows schematics of three designs with the associated couplers concepts to damp the different modes. A merit sheet is under construction to evaluate the various

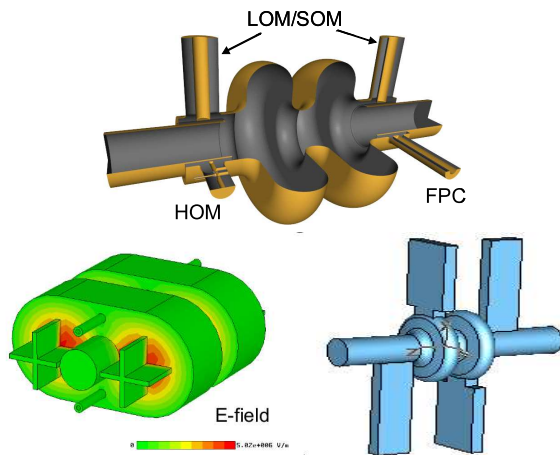

Figure 12: Three cavity-coupler concepts (LARP, KEK-B, UK) to strongly damp LOM, SOM and HOMs in the elliptical cavities to reach the tight tolerances put forth by the LHC instability thresholds.

pros and cons of the different designs based on RF performance, maximum surface fields, damping limits, multipacting, mechanical complexity, fabrication, cavity treatment, cryostat, assembly, coupler based tuning and operation complexities to down select a single prototype design. The final design could also result in a hybrid of the existing concept.

COMPACT STRUCTURES

Due to the very tight transverse size constraint posed by the LHC along with the long bunch length (7.55 cm) of the protons, 800 MHz was found to be the best compromise. However, lower frequencies is preferred as the crossing angle is increased further which calls for compact designs. As a result a number of groups from the crab cavity collaboration have proposed novel designs towards a more transversely compact design at 400 MHz (see Fig. 13).

Some of the different compact concepts under investigation are:

- A SLAC design aiming a $\frac{1}{2}$ -wave structure (typically referred to as $\frac{1}{4}$ -wave structure for the TM_{010} mode). A similar design is under fabrication for use in RHIC to improve the losses at transition and collision energy operated at TM_{010} mode. It maybe possible to drive this structure when installed in the deflecting mode to probe several issues related to hadron colliders.
- A spoke structure operated at the deflecting mode. This structure although mechanically stable has strong multipacting issues and kick gradients are typically smaller than the elliptical counter parts.

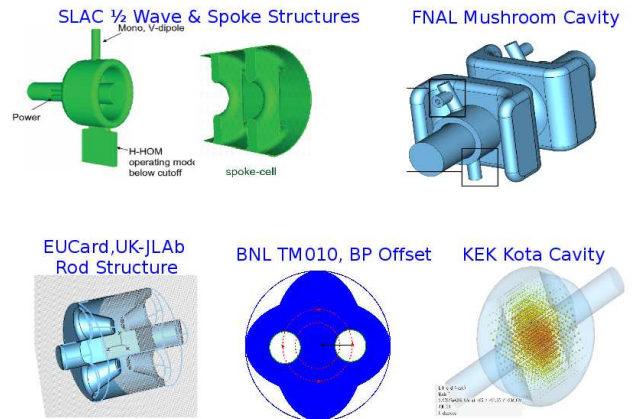

Figure 13: Compact structures by various groups around the world partipating the crab cavity collaboration to develop novel concepts for low frequency deflecting cavities in a compact form

- A FNAL mushroom type cavity which uses the typical concept of the elliptical cavities but with dramatic bends to reduce the transverse size. This structure is also prone to heavy multipacting near the bend regions which need detailed study and a similar struture is under testing but at higher frequencies.
- A UK design of the original JLAB type double rod structures. The original design consisted of cylindrical rods which were sensitive to mechanical resonances, so conical cross sections for the rods are employed to improve mechanical stability.
- A BNL proposal to use TM_{010} mode in the conventional pill-box struture but with offset beam pipes close to the cavity equator to utilize the kick from magnetic field of this mode. Although the concept is conceptually simple and HOM damping relatively simpler compared to the other designs, the large offsets in the cavity may lead to higher order cavity modes to couple to the beam very strongly which is not desired. Additionally, the non-zero longitudinal electric field needs to be compensated. Multipacting needs careful to be evaluated in such a configuration.
- A KEK proposal to use a similar pill-box type structure but with beam-pipes mounted transversely to the cavity as opposed to the nominal pill-box. In this configuration the transverse electric field is use to deflect the bunch and special nose cones are required to shield the magnetic field.

The compact designs are potentially critical for the phase II upgrade where the maximum space even with a redesign of the IR is smaller than in IR4. Since, the time scale of the phase II upgrade is approximately 9-10 years, there is sufficient time to evaluate the merits of the several proposed concepts and prototype them to define a final candidate to

replace the conventional elliptical cavity. Simultaneously, it is expected that the frequency of the compact design will be lowered to 400 MHz or smaller while maintaining the same transverse profile.

IR4 & CRYOSTAT

The complex structure of the cavity-coupler geometry with the tight LHC beam line constraints make the cryostat design challenging. Fig. 14 shows the present layout in the IR4 region and the anticipated location for the crab cryomodule near the ACN capture cavities. In addition to the cryostat, the infrastructure to support the cryomodule need significant R&D. It is anticipated that the present 4.5 K helium line supply to the main RF will be extended towards the ACN cavity region to supply the crab cavities. There are some disadvantages from operating at 4.5 K like higher losses, microphonics from boiling helium and lower gradients which need to be evaluated. If the evaluation mandates a 2 K operation, the cryostat will be equipped with special dedicated pumping system along with additional thermal shielding.

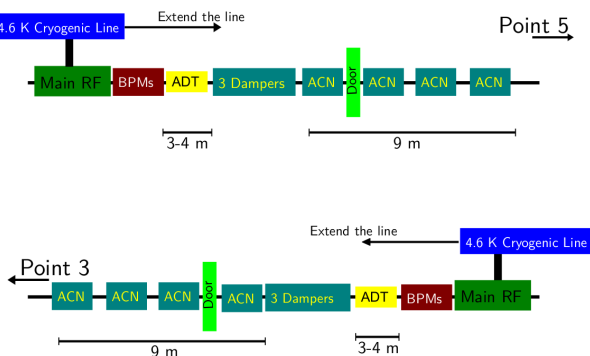

Figure 14: Layout of the current IR4 region in the LHC. The ADT and ACN locations are the anticipated dampers and capture cavities where the crab cryomodule is anticipated to be located.

Even with the special dog-leg in the IR4 section, the beam lines are separated to a maximum of 42 cm. This requires that the second beamline to pass through the cryostat similar to that of the main RF. Therefore, cavities for both beam lines along with their helium vessels and magnetic shielding should fit within the allowed 42 cm comfortably. Additionally the beam line closer to the tunnel wall (see Fig. 15) has another constraint due to the large cryogenic line passing through at approximately 42-45 cm. This requires a special design for the cryostat to be able to accommodate the magnetic and thermal shielding and the outer shell to fit within the available 42-45 cm space. It should be noted that the length of the cryostat is also very restrictive (~ 3 m) if the capture cavities are required for LHC operation.

The cryogenic supply, safety, protection, vacuum, radi-

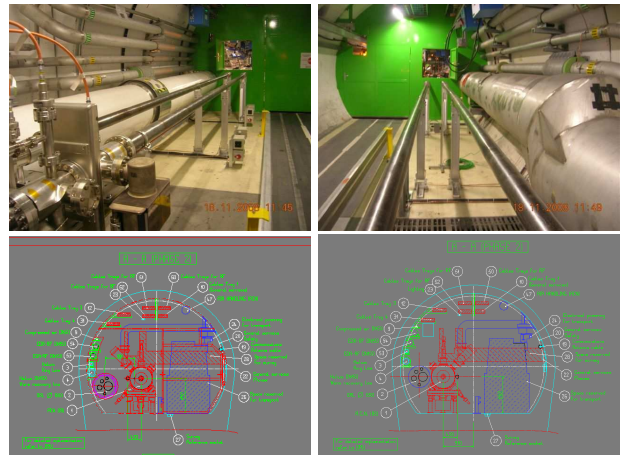

Figure 15: Schematic of the ACN capture cavity region which could be potentially be used for the crab cavities. A solution to accommodate both ACN cavities and crab cryomodule is under study.

ation, power systems, RF transmitting lines, water cooling and additional support infrastructure are under study and need to comply to CERN standards. A preliminary cryogenic circuit linked to the QRL for 4.5 K operation is shown in Fig. 16. The helium return line goes to 20 K at 1.3 bar. A back pressue control valve is required to prevent pressurizing the helium vessel since this line serves as a magnet quench heater which can potentially reach 20 bar. A similar circuit also exists for 1.8 K operation where 5 K helium at 3 bar is drawn from the transfer line to generate 1.8 K saturated helium in a manner similar to the magnets. A relief valve and a rupture disk is required for the helium vessel either at 300 K or optionally at 20 K. The 20 K connection is not desired due to potential leaks into the low pressure helium vessel. An additional relief valve shown in Fig. 16 at 300 K would also be needed to lower the pressure in the collection line. The relief valves required to protect the helium vessel is already in place for cryogenic line providing the main RF cavities. If the same 4.5 K helium supply line is utilized for the crab cryomodule, pressuring of helium vessel is not a significant issue and interface to the crab cryomodule will be modified accordingly.

APERTURE & COLLIMATION

The tight aperture constraints imposed by the LHC collimation system for machine protection and quench prevention leaves very little or no margin for additional aperture [18]. Some of the main reasons for such tight tolerances and constraints are:

- The LHC nominal beam has 360 MJ of stored energy which is confined in a superconducting environment.
- Therefore, the LHC collimators must sit very tight on the beam to provide good passive protection and cleaning for the elements in the machine.

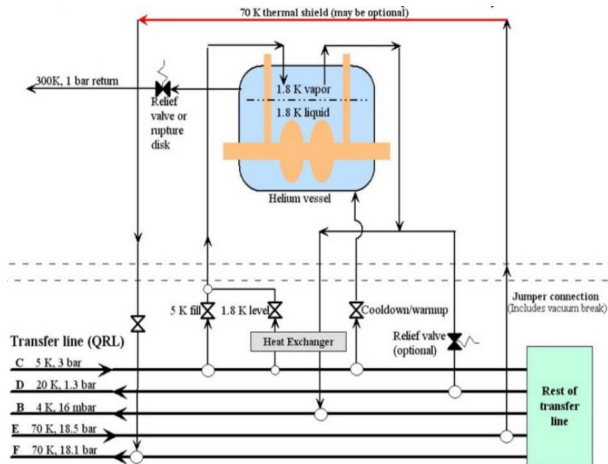

Figure 16: 4.5 K cryogenic circuit envisioned from the crab cryomodule with corresponding relief valves and a return line to 20 K at 1.3 bar. A similar circuit exists for 1.8 K operation where 5 K helium at 3 bar is used in a similar concept as the superconducting magnets to generate saturated helium. A relief valve and rupture at 300 K or optionally at 20 k is required to avoid pressurizing the helium vessel.

- As a consequence, the 6D phase space must be well defined such as tolerances on relative settings and retraction.
- Off-momentum beat is important and is being addressed [4] Larger off-momentum beta beat with upgrade optics.
- A global crab cavity scheme will further complicate the situation, potentially to the point where collimation and machine protection break down. Detailed studies are required.
- Interference between the local crab cavities and collimation in experimental insertions must be analyzed.

A global crab scheme would approximately require an additional 0.6σ of aperture (see orbits in Fig. 17) to accommodate the tilted bunch. The horizontal retraction of the collimators would be reduced with the consequence of even tighter tolerances and perhaps larger losses [20]. The impact of the global crab scheme on LHC collimation is under study to define the exact retraction and associated tolerances. Fig. 18 shows the additional beta-beat for a globally crabbed beam with nominal LHC parameters which is compared to the off-momentum β -beat. The crabbed beam β -beat is approximately a factor of 10 less and is not foreseen to be an issue. However, the tolerance imposed by large off-momentum β -beat is very severe. Mitigation of this β -beat with appropriate optics solution is essential for any IR upgrade scenario. A solution which significantly reduces the off-momentum beta beat at the collimators (down to $\beta^* \sim 0.2$ m) has been recently been developed by spe-

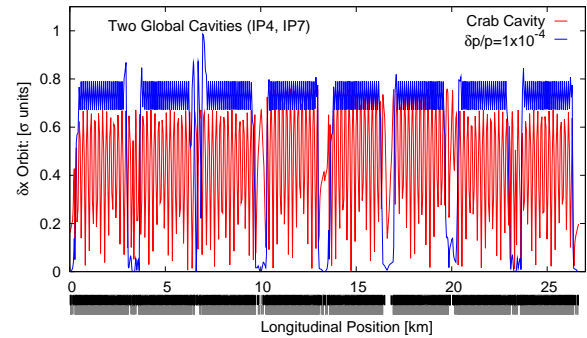

Figure 17: Orbit deviation of a $1\sigma_z$ particle for a globally crabbed beam compared to deviation of a particle at $1\sigma_{\delta p/p}$.

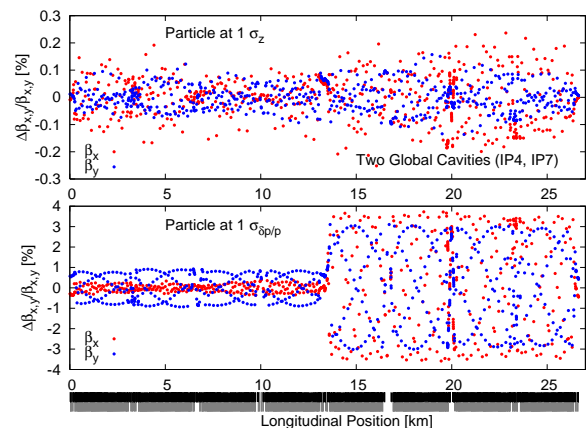

Figure 18: Top: β -beat of a $1\sigma_z$ particle for a globally crabbed beam compared to a particle at the center of the bunch. Beta beat of particle with momentum deviation of $1\sigma_{\delta p/p}$ compared to synchronous a particle.

cial powering of all arc sextupoles and optimizing phase advances between the arcs [19].

Further studies will investigate in more detail the possibilities to test the global crab scheme with the LHC beams, while ensuring machine protection and efficient collimation at all times.

PHASE NOISE & EMITTANCE GROWTH

Several sources of emittance growth due to imperfections of crab compensation have been identified. The required amplitude (or voltage) jitter tolerance is approximately 0.04% which is 4 times more relaxed than compensation possible with available low level RF technology ($\sim 0.01\%$). However, phase jitter from the RF sources can become a major concern especially for high frequency or white noise type spectrum. A phase error in the RF wave causes an offset of the bunch rotation axis translating into a transverse offset at the IP as shown in Fig. 19. The offset

at the IP is given by

$$\Delta x_{IP} = \frac{c\theta_c}{\omega_{RF}} \delta\phi \quad (5)$$

where θ_c is the full crossing angle and $\delta\phi$ is the phase error.

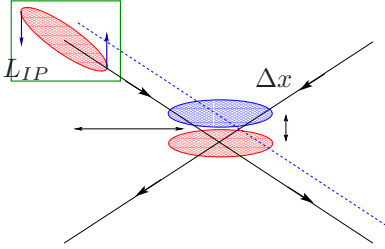

Figure 19: RF phase jitter of the crab compensation results in a transverse offset of the bunch at the IP.

This random offset at the IP coupled with beam-beam is potentially severe. In addition the phase jitter can lead to random dipole kicks to the beam which can lead to even more severe emittance growth. For nominal LHC upgrade parameters and 2 IPs using 800 MHz crab cavity, Fig. 20 shows the luminosity evolution with varying random uncorrelated phase noise (white noise) [9]. These strong-strong beam-beam simulation indicate 0.1% noise tolerance for 1-day luminosity lifetime for fast noise (or white noise) which is pessimistic. Measurements of the phase jit-

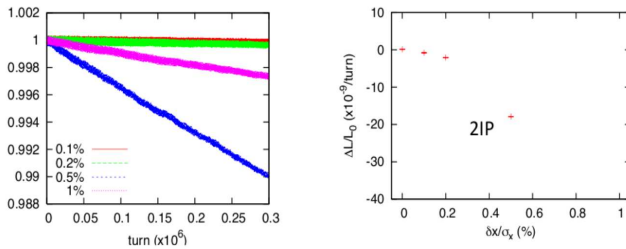

Figure 20: Luminosity evolution for varying random uncorrelated phase noise with nominal LHC parameters, 2 IPs and 800 MHz crab cavity

ter from the KEK-B crab cavities show that the noise modulation is not “white” but has a frequency spectrum as shown in Fig. 21 (courtesy K. Akai). Sidebands of -65 db below the main RF signal (509 MHz) are visible in a 200 Hz span (32Hz, 37Hz, 46Hz, 50Hz, 100Hz) and sidebands of almost -80db down are visible in a 200 kHz span (32 kHz, 64kHz). A wider span of 3MHz show no visible sidebands above the noise level. In addition recent measurement in KEK-B with artificially injection noise from the crab cavity at specified frequencies indicate a clear beam blow up only very close to the betatron sidebands with noise levels that more than 30 dB larger than that measured from the cavities in nominal operation with high intensities [23].

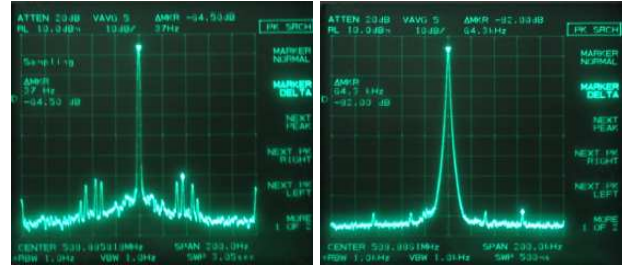

Figure 21: Spectrum of the KEK-B crab cavities during operation with a. frequency span of 200 Hz (left) and 200 kHz (right). The main frequency line is modulated by the sidebands which are approximately -60 dB and -80 db below the main line (Courtesy KEK crab cavity group).

Simulations were performed including beam-beam offset (weak-strong) with frequency dependent noise like the ones in Fig. 21. Fig. 22 shows the emittance growth as a function of the amplitude for three different sine like effects similar to the ones observed in the KEK cavities. A quadratic fit to the 32 KHz (one of the fastest frequencies observed in KEK-B) line suggests a maximum tolerance of $\sigma_{noise} \approx 6 \times 10^{-12}$ m corresponding to an emittance growth of 1% per hour. The measured amplitude of -80db translates to an IP offset of 6×10^{-13} m which is an order of magnitude smaller than the maximum tolerance for 1% emittance growth per hour.

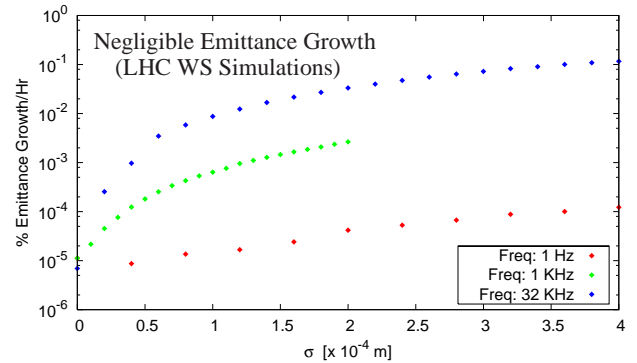

Figure 22: Simulated emittance growth for a beam-beam offset at two IPs modulation at different frequencies (1 Hz, 1KHz, and 32 KHz) at the IP ($\beta^* = 0.25m$) as a function of the modulation amplitude.

Also, simulations in Ref. [22] and as seen in Fig. 20 suggests that the tolerances can be relaxed linearly with the correlation time of the noise source. Since slow noise sources are generally dominant, the phase tolerance should be much less stringent than and be compensated with RF technology available today. In addition a active transverse feedback should relax the requirements further.

OPERATIONAL ISSUES

The operation of the prototype cavity with beam requires a well defined scenario(s) for the test which is designed to test various RF and beam related aspects with crab crossing in the LHC. A workshop to focus on the validation requirements was held on August 21, 2008 at CERN which resulted in several recommendations towards establishing a successful test in the LHC [4]. Some of the main recommendations are listed as follows:

- Hardware must be extensively tested before installation in the tunnel
- LHC performance shall not be reduced, at the event hardware fails and adequate measures have to be in place to ensure the safety of the machine
- A large enough effect on luminosity ($> \pm 10\%$) must be aimed at for the demonstration to be convincing.

Due to uncertainty in the final optics and the maximum possible kick gradient in the cavity, special measures need to be defined in the test scenario(s) to ensure adequate margin while proving unambiguously a luminosity increase. In addition the test scenario(s) will outline a detailed procedure for the operation of the crab cavity during all phases of the LHC operation (injection, energy ramp and collision energy). Some of the preliminary procedures for this operation include:

- Orbit control of the cavity using local feedback system based on the deflecting mode power. The beam loading the cavity is given by

$$V_b \approx Q_L I_b \frac{R_{\perp}}{Q} (\delta x) \quad (6)$$

The beam loading is approximately 0.1 MV/mm using $R_{\perp}/Q_0 \approx 120\Omega$, $Q_L=10^6$, $I_b = 0.85A$. Therefore, amplifier with a maximum power 20 kW is required if the orbit is controlled within a millimeter inside the crab cavity using an active feedback system.

- Although the crab cavity is powered to zero voltage at injection and energy ramp, the frequency of the cavity is detuned and the mode sufficiently damped such way that the beam harmonics do not overlap with cavity modes and result in instabilities. In KEK-B, the cavities are detuned by approximately 1 MHz or less and simulations are underway to determine the detuning and damping requirements for the cavity to become invisible when not in use.
- At collision energy, the cavity will be ramped up to its nominal voltage and the ramp rate should be adiabatic to avoid emittance dilution. Fig. 24 shows a simulation of the emittance evolution as a function of the crab cavity ramp speed. The tracking using a linear lattice with LHC nominal lattice, chromaticity sextupoles and octupoles with their nominal strength

at collision. The cavity is ramped up and then later ramped down to ensure that any growth from numerical noise of coordinate transformations are not attributed to voltage ramping. These simulations indicate that a voltage ramp of 10 turns is sufficient to preserve the emittance. Superconducting cavities operating at high Q's naturally take time to ramp their voltage and hence a non-issue.

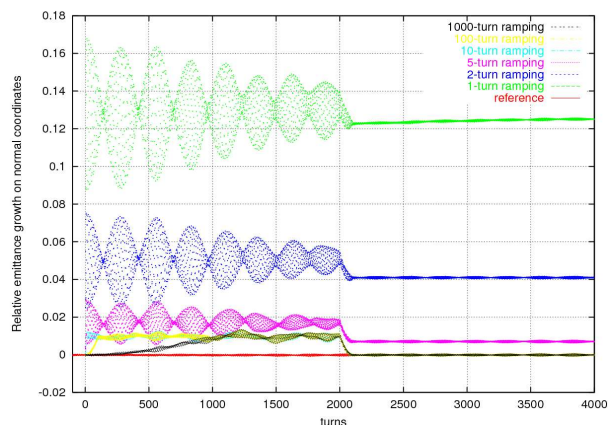

Figure 23: Simulated emittance growth during a crab cavity ramp to nominal voltage for nominal LHC optics and $\beta^* = 55\text{cm}$. Octupoles were put to their nominal strength at collision energy to induce non-linearities. The voltage was ramped down to zero value to affirm that the emittance growth observed was not attributed to numerical noise.

PRELIMINARY SCHEDULE & DISCUSSION

Due to the constraints put forth by the LHC operation, upgrade schedule, complexity of the cryomodule and the numerous institutions involved in project, it was deemed necessary to have long term plan and define a road map towards final cryomodule to be tested in the LHC during the phase I upgrade. Fig. ?? shows a preliminary draft of such a plan which encompasses R&D components of the cavity cryomodule, beam simulations, fabrication and testing of the cavity within the time frame of the phase I upgrade.

A 2nd workshop is anticipated in Fall 2009 to discuss the intermediate progress of the project and focus on the cavity-coupler development to down select a single design and finalize the engineering details. A comprehensive review in late 2010 for full cryomodule and the associated infrastructure will initiate the fabrication, assembly and RF testing phase to continue through 2012. The installation and beam testing will subsequently follow depending on the LHC upgrade schedule and priorities. The 4 year R&D program since 2004 carried out by a joint collaboration between LARP and CARE networks has resulted in a global collaboration formed in 2008 which includes several laboratories from the United States, Europe and Japan. The proposed five year plan will now be carried out this collab-

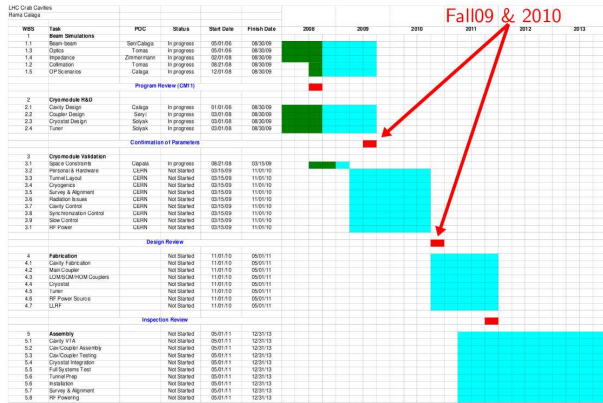

Figure 24: Preliminary five year schedule for the crab cavity project including R&D, tunnel infrastructure, fabrication, treatment, RF testing, installation and beam testing.

oration towards a successful and first demonstration of crab crossing in the highest energy hadron collider.

ACKNOWLEDGEMENTS

We would to thank several members of the crab cavity collaboration for valuable discussions and suggestions in particular K. Akai, J. Barranco, L. Bellantoni, J. Byrd, F. Caspers, M. Cole, A. Dexter, L. Evans, S. Fartouk, T. Favale, W. Fischer, R. Gupta, D. Holmes, D. Li, P. Limon, T. Markiewicz, E. Metral, K. H. Mess, A. Nassiri, H. Padamsee, S. Peggs, E. Prebys, A. Ratti, W. Scandale, S. Simrock, T. Weiler.

APPENDIX A: LHC TEST BED

The first prototype test in the LHC is vital to establish the principle of crab crossing in high energy hadron colliders. The testing of crab cavities in existing hadron colliders are not relevant because:

- Energy: different by x7-70 (LHC compared with Tevatron-RHIC)
- Bunch length: Smaller for LHC by x5-10 (i.e. crab freq. 100 MHz for RHIC or Tevatron)
 - Enormous cavities, maybe don't fit in Tevatron or RHIC
 - Cavity not driven by klystrons, therefore the noise spectrum will be completely different
 - None of the hardware is directly applicable to LHC, hence the R&D maybe irrelevant and time consuming
 - Voltage at this low frequency maybe prohibitively large, hence large number of cavities for test in RHIC or Tevatron which is not financial practical

- Phase noise tolerances and mechanical stability of the cavity are completely different from 800 MHz for the LHC

- The natural emittance growth for RHIC and Tevatron are already large and additional growth from crab cavities maybe not visible. Hence results could be inclusive
- Collimation systems are far simpler and cleaning efficiency for RHIC and Tevatron are far different from the needs of the LHC which is dominating factor for the tests in the LHC
- Impedance in the LHC is a significant factor for the tests in the LHC and far different from RHIC or Tevatron and hence making beam tests less relevant elsewhere
- RHIC and Tevatron have zero crossing angle. A study of luminosity gain (or loss) is not directly applicable to LHC case where the Pwinski angle is considerable
- Tevatron is very restrictive for beam experiments and lifetime of the Tevatron is not in the time scale of crab cavity demonstration. Also it operates in a weak-strong regime
- At RHIC additional large noise sources like 10-Hz oscillations due to triplet vibrations may make it difficult to disentangle any observable effects. Also the absence of long range beam-beam effects might render the tests less relevant compared to the LHC.

The best test bed we have is KEKB, an operating collider, with beam currents well above those for the LHC upgrades, with a factor 7 shorter bunch lengths, with crab cavities at an RF frequency close to what we envision for the LHC, and with a Piwinski angle and crab voltage which are also both very similar to the future LHC values. The only other place that can be foreseen is the SPS, but still with longer bunches, without colliding beams, without collimation, and without sensitive impedance checks. Any test results there might prove irrelevant while introducing possible constraints on the injector operation for LHC and other physics experiments.

APPENDIX B: SEPARATE FOCUSING CHANNELS

The first proposal of the crab crossing for the LHC was a local scheme with 400 MHz cavities. However, due to the transverse dimensions of elliptical cavity, a prohibitively large crossing angle of 8 mrad was needed which was deemed too risky for the upgrade. If a compact structure at 400 MHz is realized that would significantly reduce the transverse dimension, a separate focusing channel could be envisioned for the future of the LHC upgrade. This concept could be accomplished in two paths to perhaps reach a

crossing angle of 4 mrad or smaller depending on technological and mechanical constraints:

- A separate focusing channel where the triplets are staggered to minimize the crossing angle required from the transverse dimensions of the triplet quadrupoles (see Fig. 25).

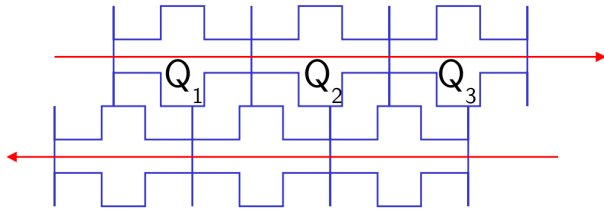

Figure 25: A staggered concept for the triplet quadrupoles to minimize the crossing angle required for the magnetic elements (courtesy R. Gupta).

- Separate coil system with common yoke for the Q_1 (see Fig. 26). This exotic coil system may present field coupling issues which could be resolved with two different types of quadrant coils [24].

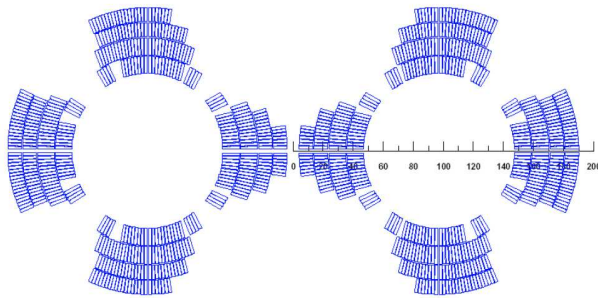

Figure 26: 100 mm asymmetric common coil design. $G_{max}=247.6$ T/m, $I_{max}=15.34$ kA ($J_c=3000$ A/mm², 12T, 4.2K, courtesy V. Kashikin).

The effects of the large crossing angle can also be partially mitigated by having flat beam where the beam size in the crossing plane is larger. Separate focusing channels provide significantly larger flexibility in tuning of the IP parameters while simultaneously eliminating long range beam-beam effects and make flat beam optics easier. Additionally the requirement of alternate crossing angle at the two IPs is removed, thus eliminating vertical dispersion effects due to this scheme.

REFERENCES

[1] R. Calaga, E. Ciapala, R. Garoby, T. Linnekar, F. Zimmermann, CARE-Conf-08-030-HHH
 [2] R. Calaga et. al, C-AD 308, LARP-doc 707, CARE-08-002.

[3] R. Calaga et al., proceedings of IR07, Frascati, Italy (2007).
 [4] R. Calaga et. al, in the proceedings of LUMI06, Valencia, Spain (2006).
 [5] F. Zimmermann et al., in the proceedings of LHC-LUMI-05, Arcidosso, Italy, 2005.
 [6] D. Schulte. TESLA-97-08 (1996).
 [7] Y. Morita, presented at the LHC crab cavity validation workshop, CERN, Geneva (2008).
 [8] W. Scandale, presented at the CARE-HHH-APD BEAM'07, CERN, Geneva (2007).
 [9] K. Ohmi, presented at the LHC beam-beam effects and beam-beam compensation, CERN, Geneva (2008).
 [10] J. Tuckmantel, Private communication.
 [11] R. de-Maria, private communication.
 [12] R. Tomás, presented at the LHC-CC08, BNL, NY (2008).
 [13] Y. Chin, User's Guide Ver 9.4, CERN SL/94-02.
 [14] G. Burt, private communication.
 [15] E. Shaposhnikova, LHC Project Note 242 (2000).
 [16] F. Sacherer, IEEE Tr. Nucl.Sci. NS-20 , 825 (1973).
 [17] V. Balbekov et al., IHEP Preprint 91-14, Protvino (1991).
 [18] R. Assmann et al., LHC project note 277.
 [19] S. Fartoukh, presented at LIUWG meeting, 2008.
 [20] R. Assmann, presentation at the LHC-CC08.
 [21] J. Frisch, NLC Crab Cavity Phase Stability, LCC-0136, SLAC-TN-04-004, 2004.
 [22] K. Ohmi, Beam-beam effect with an external noise in LHC, these proceedings.
 [23] R. Tomás et al., AB note (to be published).
 [24] R. Gupta, private communication.