

Analysis of the initial performance of the ATLAS Level-1 Calorimeter Trigger

D. Prieur

Rutherford Appleton Laboratory, Chilton, Didcot, OX11 0QX, United Kingdom

On behalf of the ATLAS collaboration

damien.prieur@cern.ch

Abstract

The ATLAS first-level calorimeter trigger is a hardware-based system designed to identify high- p_T jets, electron/photon and tau candidates and to measure total and missing E_T in the calorimeters. The installation of the full system of custom modules, crates and cables was completed in late 2007, but, even before the completion, it was being used as a trigger during ATLAS commissioning and integration. During 2008, the performance of the full system has been tuned during further commissioning and cosmic runs, leading to its use in initial LHC data taking. Results and analysis of the trigger performance in these runs will be presented.

I. INTRODUCTION

The Large Hadron Collider (LHC), the new CERN proton-proton collider, is designed to run at 7 TeV per beam and a nominal luminosity of $10^{34} \text{ cm}^{-2}\text{s}^{-1}$. With such a luminosity, each bunch crossing will generate 23 collisions, leading to a rate of 10^9 interactions per second. However, most of these events will be minimum bias and not so interesting in the search for new physics. On the other hand, processes such as the Higgs boson production are 10 orders of magnitude below the proton-proton inelastic cross section, meaning that stringent selections will have to be applied to access such rare events.

Another constraint comes from the data storage performance, limiting the rate of data that can be recorded to tape to 300 MB/s. With an average ATLAS event size of 1.5 MB, the acquisition rate has to be reduced from the LHC bunch crossing rate of 40 MHz down to 200 Hz, while keeping only the most interesting events. To achieve such a goal, ATLAS has designed a three-level trigger strategy as shown on figure 1.

The Level-1 Trigger (L1) [1] is composed of dedicated electronic boards and gets its input from the calorimeters and muon systems. It looks for basic physics signatures to take a trigger decision in less than $2.5 \mu\text{s}$ and it must reduce the trigger rate to a maximum of 100 kHz. At each Level-1 decision (L1A), the region-of-interest (RoI) event information is sent to the Level-2 Trigger.

The Level-2 Trigger (L2) [1] accesses the regions of interest (RoI) generated by Level-1 using the full detector granularity. A large computer farm runs more detailed software algorithms to select events to reduce the trigger rate to 2 kHz with an average processing time of 40 ms.

The last trigger stage, called Event Filter [1] (EF), has access to the full event information, and also to the calibration constants, to run offline-like reconstruction algorithms in order

to limit the final recording rate to tape to a maximum of 200 Hz. The average processing time of the event filter is a few seconds.

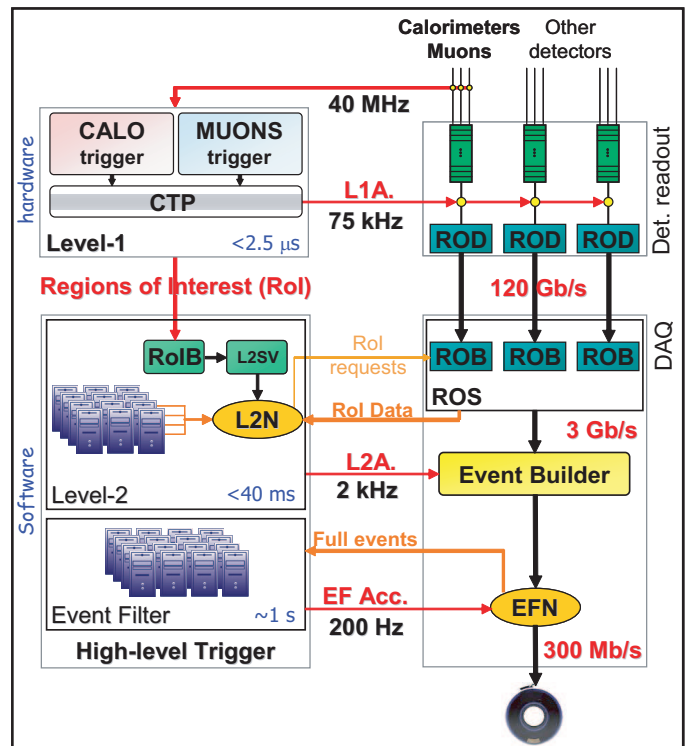

Figure 1: Overview of the overall architecture of the ATLAS Trigger system [1].

II. LEVEL-1 CALORIMETER TRIGGER ARCHITECTURE

The Level-1 Trigger system is composed of three sub-systems : the Calorimeter Trigger [2], the Muon Trigger and the Central Trigger Processor (CTP), as shown in figure 2. Potentially interesting events are selected by identifying and counting the multiplicities, per p_T threshold, of e/γ , $\tau/hadron$, jets or μ candidates, and also various energy summations. The CTP receives and synchronizes all these information from the Level-1 Calorimeter and Level-1 Muon and decides whether or not to generate a L1 trigger decision, according to a pre-defined trigger menu.

The Level-1 Calorimeter Trigger (L1Calo) system is a digital pipeline partitioned into three sub-systems, as shown in figure 3. It receives signals from the electromagnetic and hadronic

ATL-DAQ-PROC-2008-005
18 November 2008



calorimeters, but works on a coarser granularity, based on trigger towers of size $\Delta\eta \times \Delta\phi = 0.1 \times 0.1$ in the barrel region.

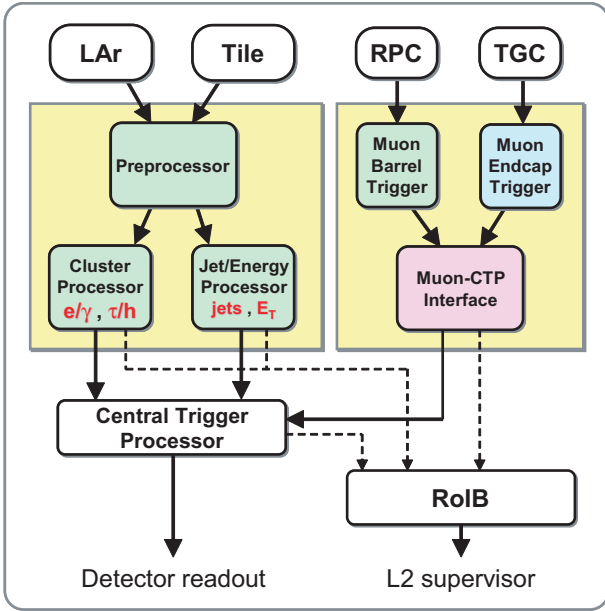

Figure 2: Overview of the ATLAS Level-1 Trigger.

A set of Pre-processors (PPr) boards digitize the signals from the 7168 trigger towers using a 10-bit Flash-ADC, at a sampling rate of 40 MHz and add a pedestal of 40 ADC counts. The main role of the Pre-processors is to determine the final transverse energy value and to assign it to the correct bunch crossing (bunch crossing identification - BCID). The BCID mechanism uses a finite impulse response (FIR) filter to extract the signal amplitude and a peak finder algorithm to perform the signal peak identification, in either the linear or saturated regime. The coefficients of the FIR filter will be determined in order to maximize the signal/noise ratio. The output of the FIR filter is then passed to a look-up table (LUT) which is used for the pedestal subtraction, to perform noise suppression and to convert the final energy from ADC counts (10 bits) to GeV (8 bits).

The Pre-processors send the energy data from each trigger tower to the downstream Cluster Processor (CP) and Jet/Energy-sum Processor (JEP). Both of these processor systems run sliding window algorithms on the input matrix of trigger tower energies, looking for physics signatures. The Cluster Processor system identifies and counts e/γ and τ candidates while the Jet/Energy-sum Processor system counts jets candidates and also computes the missing and total transverse energy sums.

In the case of the Cluster Processor system, the identification of physics signatures requires the sliding window algorithm to be applied in overlapping windows of 4×4 trigger towers, from both electromagnetic and hadronic calorimeters, as shown on figure 4. To process each trigger tower, the physics algorithm must examine the neighboring trigger towers. The consequence is that a very large amount of information has to be duplicated between the processing units, modules and crates.

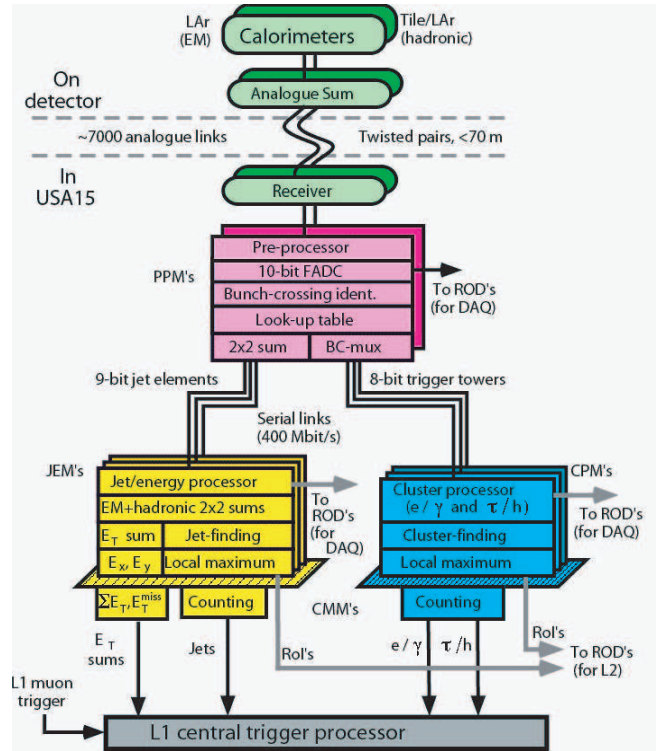

Figure 3: Overview of the ATLAS Level-1 Calorimeter Trigger system.

For each window, the CP algorithm considers a 2×2 tower core region and an isolation ring around it in each of the electromagnetic and hadronic layers. Several energy thresholds are defined in the trigger menu to specify a minimum energy deposit in the electromagnetic core region or in the hadronic core one to distinguish between e/γ and τ candidates. Thresholds are also set in the isolation ring for trigger items requesting an isolation criterion.

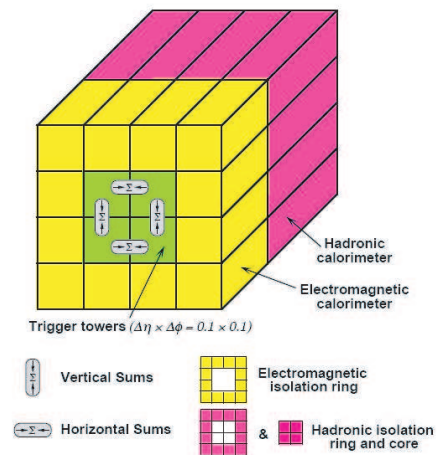

Figure 4: The 4×4 trigger tower area (electromagnetic & hadronic) being considered by a Cluster Processor module when running its sliding window algorithm.

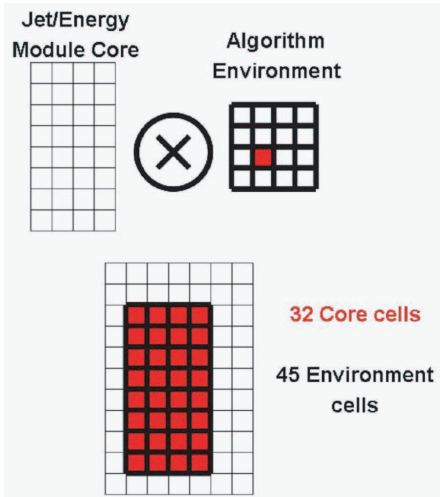

Figure 5: Core and environment jet elements considered by an individual Jet/Energy sum Processor module.

The Jet/Energy-sum Processor system works in a similar way, except that it uses *jet elements* rather than trigger towers. A jet element is the digital summation of the energy of four electromagnetic and four hadronic trigger towers. Hence, the granularity of a jet element is $\Delta\eta \times \Delta\phi = 0.2 \times 0.2$ in the barrel region. Each JEP module process a 4×8 core region, but it also has to consider a full environment of 7×11 jet elements around the core region, overlapping with the neighbor JEP modules as shown in figure 5. Each jet trigger item has to specify a window size around the core region (2×2 , 3×3 or 4×4 jet elements) to be used to compute the jet transverse energy.

The processor system is designed to provide real time output information to the Central Trigger Processor, where the ATLAS Level-1 trigger decision is taken. It also provides readout data at the L1A rate to the Data Acquisition system (DAQ) and generates the Regions of Interest information for the Level-2 Trigger system.

III. COMMISSIONING

The Level-1 Calorimeter trigger system has been fully installed in the ATLAS electronics cavern since the end of 2007, when the production of the electronic boards was completed and the last modules were installed and cabled. The Level-1 Calorimeter system then entered an intense commissioning phase. A lot of systematic hardware, as well as software checks were performed. The system has been operating either in stand-alone or combined mode, together with the calorimeters, making effective use of their calibration systems (electrical or optical).

The Level-1 Calorimeter trigger was also involved in all the integration and data taking campaigns that have taken place over the last year. The data taking periods consisted mainly in looking at and recording muons produced in cosmic ray showers. This activity proved to be very useful to understand the data acquisition chain and to check further the analogue and digital parts of the system. The recorded information was also used for

detailed comparisons with the calorimeter's precision readout. The regular overnight runs were helpful to assess the system stability over a long period of time. In parallel a serious effort was made to set up the timing across the whole system and several calibration procedures have been developed for that purpose [3].

In the end it demonstrated that the Level-1 calorimeter system was behaving as intended and was able to generate reliable trigger decisions for the ATLAS detector.

A. Pedestal & noise level

To provide a robust trigger decision, the system has to have good control over the pedestals applied at the Pre-processor level and the amount of noise in the trigger towers.

Calibration procedures [3] have been developed to set up the pedestal levels at their nominal value of 40 ADC counts under control of DACs. However that procedure cannot set the pedestals to the desired value with a precision better than a few ADC counts. Therefore dedicated pedestal runs have to be recorded to measure the real pedestal level, check their stability and to monitor any possible shifts that would have important consequences on the trigger rates. Results of such a run are shown in figure 6. The average value of the pedestals over the 7168 trigger towers is close to the nominal value with a reasonable dispersion of few ADC counts.

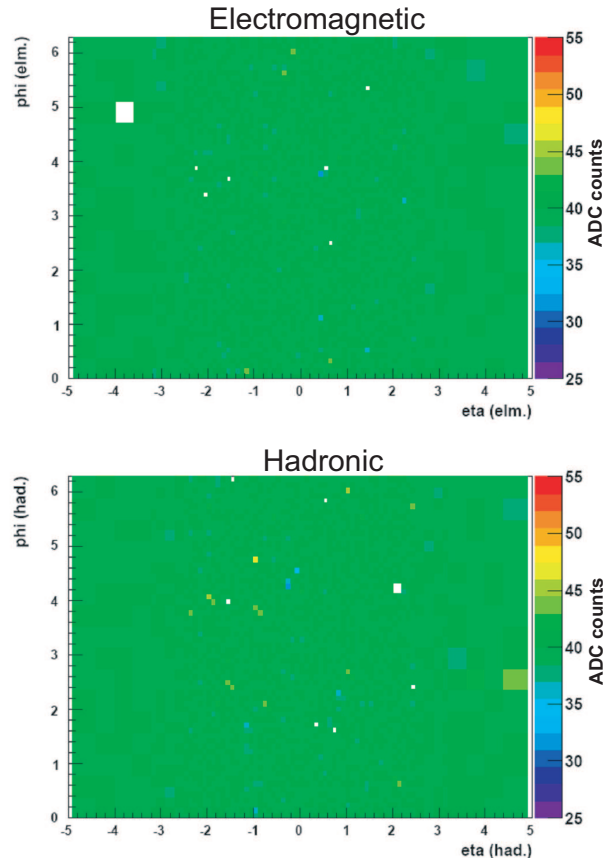

Figure 6: Measured pedestal level for each electromagnetic (top) and hadronic (bottom) trigger tower of the Level-1 Calorimeter trigger.

The noise level for each trigger tower can be observed in figure 7. These graphics include the intrinsic Level-1 Calorimeter trigger noise but also the contributions from the calorimeters electronics. When the calorimeter electronics is switched off, the intrinsic Level-1 Calorimeter noise is about 1.4 ADC counts. Switching on the calorimeter typically raises this level to 3 ADC counts (with receiver gains set to 2). With the gains set at the expected level for E_T correction, the noise level is of the order of 400 MeV, varying with eta. It is possible from figure 7 to distinguish the regions where the calorimeter electronics were switched on, because of the higher noise level in the corresponding trigger towers. In the electromagnetic layer, only the barrel part ($|\eta| < 1.4$) was active, while in the hadronic layer the tile calorimeter barrel ($|\eta| < 0.8$), extended tile calorimeter ($0.8 < |\eta| < 1.4$), and hadronic end-cap ($1.4 < |\eta| < 2.5$) were active. It is also possible to spot on that figure a few temporary problems, like power supply issues in one of the Tile calorimeter drawers or in a liquid argon front end crate.

Less than 1% of the trigger towers (about 20 trigger towers) appear to be misbehaving, with either a pedestal level significantly different than expected or channels being abnormally noisy. Such channels are disabled to prevent fake trigger decisions while the origin of these problems is being understood and fixed.

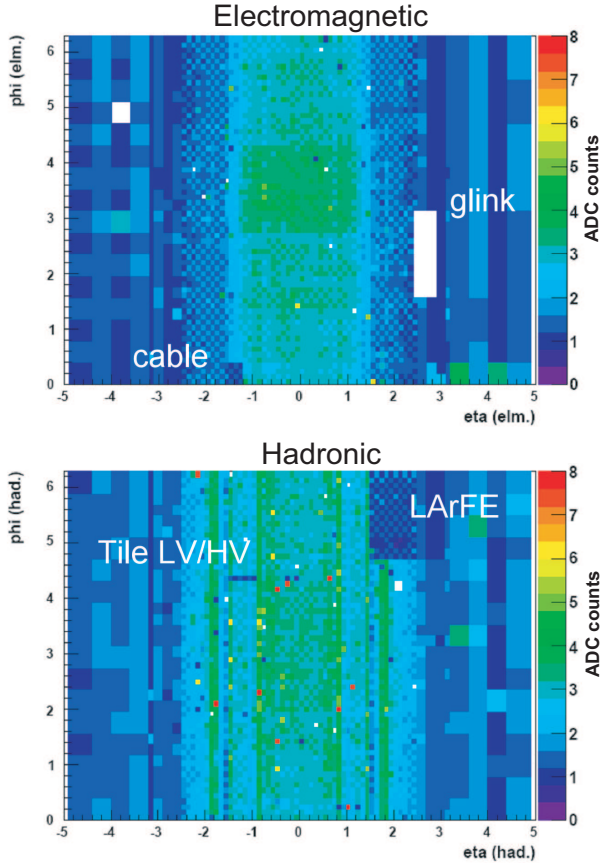

Figure 7: Measured noise level for each electromagnetic (top) and hadronic (bottom) trigger tower of the Level-1 Calorimeter Trigger.

B. Correlation with calorimeters

The Level-1 Calorimeter Trigger data path being independent from that of the calorimeters, it is extremely important to make sure that, for a given event, both systems reconstruct the same energy information.

Figure 8 shows such a correlation between the Level-1 Calorimeter Trigger readout and the calorimeter precision readout, from an overnight cosmic run. The transverse energy reconstructed by the Level-1 Calorimeter Trigger matches reasonably the readout from the calorimeters. Though not perfect, the correlation achieved is quite satisfactory, considering that the calibration constants used were far from being optimized.

In addition, the Level-1 Calorimeter system has been designed to work synchronously with the 40 MHz LHC clock, which is not the case when triggering on cosmic muons, which hit the detector asynchronously. It is therefore impossible to set the fine timing so that all cosmic muons are sampled correctly, which causes additional spread in the transverse energy reconstruction.

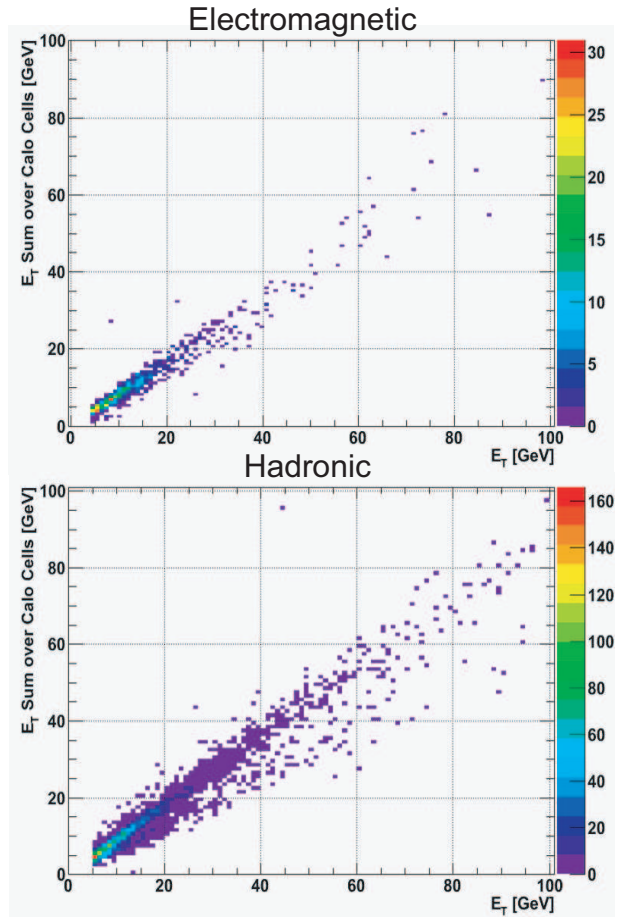

Figure 8: Correlation between the transverse energy E_T (GeV) reconstructed by the Level-1 Calorimeter Trigger system and that from the calorimeter precision readout for the electromagnetic (top) and the hadronic (bottom) layers. The calorimeter transverse energy is computed as the E_T sum of all the calorimeter channels belonging to the relevant trigger tower.

C. E_T thresholds & trigger rates

Figure 9 shows the E_T spectrum for e/γ and τ candidates found by the Cluster Processor system from a cosmic run. The different colors represent the E_T thresholds, corresponding to different trigger items (1EM5, 1TAU5...), passed by the candidates. Up to 8 thresholds can be configured for the e/γ candidates and another 8 for the τ ones. Different pre-scale settings can be applied individually to the trigger items to decrease arbitrarily the corresponding trigger rate. This is the case for example for the 1TAU10, 1TAU20 and 1TAU30 items shown in the τ graphic. Specific algorithms running at the Level-2 trigger or higher can also be used to reduce the trigger rate. This is the case in the e/γ graphic of figure 9 for the 1EM5 trigger item, for which the number of candidates recorded is far smaller than for the trigger items requesting higher E_T thresholds.

The study of long overnight cosmic runs showed that the trigger rates were most of the time stable, at a reasonable level of a few hertz, confirming the capability of the Level-1 Calorimeter Trigger system to trigger on genuine events. However, from time to time some calorimeter channels can become temporarily noisy and have to be masked out of the trigger decision. The tools to spot such noisy channels and to promptly disable them are being developed. Understanding the possible noise sources from the calorimeter is not an easy task but it is crucial to keep the trigger rates under control.

IV. CONCLUSIONS

The Level-1 Calorimeter Trigger has been running a complete system since the end of 2007. A big effort has been put into the commissioning of the system and its integration with the other ATLAS sub-detectors. The L1Calo has been part of the regular data taking periods for more than one year, recording signals from cosmic muons with an increasing involvement. The accumulated experience over the past months has allowed for better control over the system in term of stability and trigger rates. The Level-1 Calorimeter trigger is now fulfilling its main role to provide reliable trigger decisions to the ATLAS detector.

Waiting for the first collisions, the focus is on the development of the calibration procedures [3] (timing, energy calibration...) to improve the overall system performance and the trigger efficiency. Another important work area concerns the corrections to be applied for misbehaving or dead channels. This is a non-trivial task that will require further studies.

REFERENCES

- [1] The ATLAS Collaboration, G. Aad et al., The ATLAS Experiment at the CERN Large Hadron Collider, 2008 JINST 3 S08003
- [2] R. Achenbach et al., The ATLAS Level-1 Calorimeter Trigger, 2008 JINST 3 P03001
- [3] R. Achenbach et al., Testing and calibrating analogue inputs to the ATLAS Level-1 Calorimeter Trigger, these proceedings

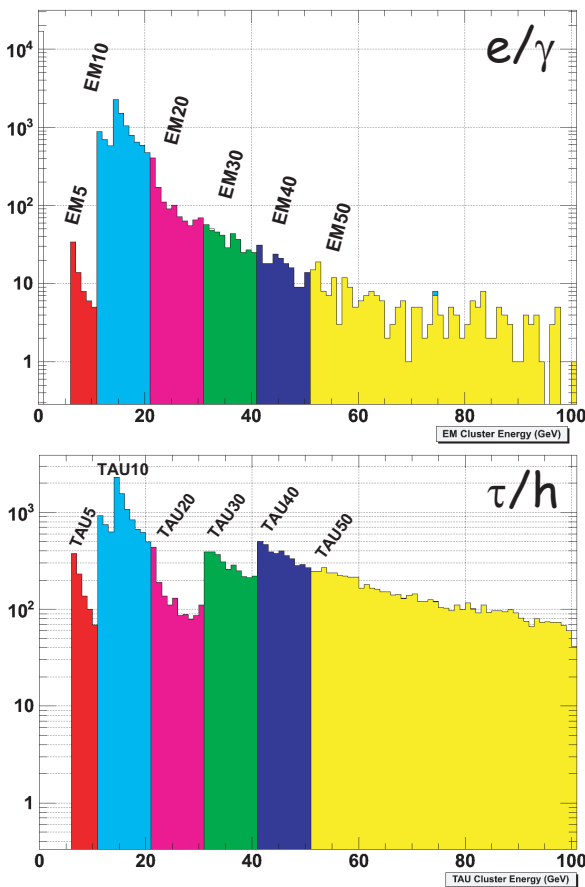

Figure 9: E_T spectrum of the e/γ (top) and $\tau/hadron$ (bottom) candidates returned by the Cluster Processor system. The various thresholds passed by the candidates, corresponding to different trigger items, are indicated with different colors on the graphic.